

**ASSESSING SUBSTATION
MEASUREMENT
EQUIPMENT**

**LCN FUND TIER 1
CLOSE DOWN REPORT
LV CURRENT SENSOR
TECHNOLOGY EVALUATION**

AUGUST 2013



WESTERN POWER DISTRIBUTION (WPD) IN CONFIDENCE

This is an internal WPD document. Recipients may not pass this document to any person outside the organisation without written consent.

Neither WPD, nor any person acting on its behalf, makes any warranty, express or implied, with respect to the use of any information, method or process disclosed in this document or that such use may not infringe the rights of any third party or assumes any liabilities with respect to the use of, or for damage resulting in any way from the use of, any information, apparatus, method or process disclosed in the document.

Telephone +44 (0) 1332 827446

Fax +44 (0) 115 902 4001

E-mail WPDInnovation@westernpower.co.uk

© **Western Power Distribution 2013**

No part of this publication may be reproduced, stored in a retrieval system or transmitted, in any form or by any means electronic, mechanical, photocopying, recording or otherwise, without the written permission of the Future Networks Manager, Western Power Distribution, Herald Way, Pegasus Business Park, Castle Donington. DE74 2TU

Foreword

As UK distribution networks migrate to a Smarter Grid, there is an increasing requirement to improve the visibility of the Low Voltage (LV) network. There is currently limited monitoring of the low voltage distribution network and as customers change their usage habits and more renewable generation connects to the network it is imperative that we are aware of and understand the impact it will have.

This project was been developed in response to a consultation issued by Western Power Distribution (WPD) and linked to the Tier 2 Network Templates project. At the time of starting the Network Templates scheme, there were no off-the-shelf LV monitoring solutions on the market. WPD took the step to develop a solution with GE based on fixed ring CTs. However, installation of these monitors required an interruption to electricity supplies. As a condition of continuing with the installations, Ofgem placed a dependency on the project that a consultation be undertaken to assess the market for alternative solutions that avoided the need for supply interruptions

The responses to this consultation proved very constructive, but no products were identified that could adequately replace the use of fixed ring CTs in the timescales of the project. The alternatives were either too costly, or were not available in the quantities required for the Network Templates project. Subsequently the LV Current Sensor Technology Evaluation project was developed to conduct a detail assessment of the market as it stood and to inform the wider DNO community of its findings.

UK Power Networks (UKPN) was separately investigating commercially available LV monitoring solutions that do not require customers to be interrupted during installation.

The two DNOs decided to collaborate to evaluate a range of LV monitoring solutions under laboratory conditions at the National Physical Laboratory and in the field on their low voltage networks, equipping at total of 28 substations with sensors from 7 different manufacturers. This report details the findings of both the field and laboratory test, along with practical learnings based around installation practices.

Western Power Distribution

Contents

1	Executive Summary	5
2	Project Overview	7
3	Details of the work carried out	9
4	The Outcomes of the Project	19
5	Performance compared with Project aims, objectives and success criteria	26
6	Required modifications to the planned approach during the Project	29
7	Significant variance in expected costs and benefits	30
8	Lessons learnt for future Projects	32
9	Planned implementation	377
10	Facilitate Replication	37
Appendix A	NPL Laboratory Report	38
Appendix B	Individual Manufacturer Assessment	65
Appendix C	Example Installation Policy	99
Appendix D	Project Change Mandates	123

1. Executive Summary

1.1. Project Scope

In order to make well informed Low Voltage (LV) network planning and operational decisions, there is an increasing need to improve our visibility of distribution substation performance. A growing uptake of low carbon technologies (LCTs), such as micro generation and electrification of transport, intensifies this need further. Many existing substation sites currently utilise low cost low accuracy maximum demand indicators with no remote reporting functionality. It is expected that greater visibility of LV network loads and voltage will be required and substation monitoring solutions will play a vital role in future network management.

The scope of the LV Sensor Evaluation project was to compare off-the shelf LV monitoring technologies that can be retrofitted to exiting distribution substation equipment. It was also intended to develop safe systems of work to allow equipment to be installed live and to identify monitoring solutions that would provide accurate and detailed information to allow the DNO to assess the performance of the LV network.

1.2. Aims

The project aimed to evaluate various current sensor technologies in both controlled laboratory and operational field environments. This project was done as a collaborative project between UK Power Networks (UKPN) and Western Power Distribution (WPD) allowing a greater range of installation scenarios to be assessed. The project also aimed to generate knowledge around the wider roll out of these monitoring technologies in the low carbon future.

1.3. Activities

The project involved working with manufacturers of LV monitoring solutions whose equipment had met the project requirements. The monitoring equipment needed to be capable of measuring the current flow in individual LV ways of an LV distribution board or cabinet. In that regard, a joint tender was completed from which 7 different monitoring solution manufacturers were selected to participate in the project.

A range of laboratory tests have been carried out at National Physical Laboratory (NPL) to assess a range of accuracy scenarios. A test bench was built at NPL using an LV cabinet ensuring that the test facilities would mimic as closely as possible the real life situation encountered in field installations. A side by side comparison was then completed using the results. A summary report of the laboratory tests can be found in Appendix A.

Another key focus of the project was the safe installation of monitoring equipment. Installation training for each manufacturer's equipment was carried out at UKPN's

Sundridge Training Centre. Following the development of installation methodologies, equipment was installed at 14 outdoor substations in Market Harborough by WPD and 14 indoor sites in central London by UKPN.

1.4. Outcomes of the project and key learning

The project has led to the development of installation policies to enable LV monitoring equipment to be installed safely and without the need for an outage on the substation. An example policy is included in Appendix C.

Several methods of making voltage connections were trialled and a hierarchy of preferred methods was developed. These included the use of existing voltage take off points, insulated and fused busbar clamp and modified fuse carriers. The transmission of data via GPRS was also demonstrated but no data integration with the DNO SCADA system was attempted as it was out of scope for the project.

Basic current and voltage measurements were provided by the equipment from all manufacturers along with the apparent, real and reactive power and power factor. A number of manufacturer's equipment offered more advanced monitoring functionality which included the measurement of neutral current, power frequency, harmonics, substation air temperature, disturbance recorder functionality and network event alarms.

The key learning from this project was firstly around the safe installation of monitoring equipment in a diverse range of substations and how the mitigation of constraints that each of these might present to the installer. Secondly, how accuracy of various monitoring solutions is impacted under different environmental conditions and installation scenarios. These assessments were carried out in laboratory testing by NPL.

The knowledge generated will allow DNOs to make more informed decisions as monitoring of the LV Network increases.

1.5. Conclusions and future work

The project led to a comprehensive evaluation of seven commercially available LV monitoring solutions and the development of installation policies to allow wider scale deployment on the LV network. The learning from the installations will also benefit any further LCNF projects involving LV monitoring.

The project demonstrated that the current generation of monitoring solutions are mature enough to allow sufficient data to be collected by DNOs to assess the performance of LV networks. Monitoring solutions can provide network load measurement with accuracies of around 2.5% for Rogowski coils, and 1% or better for solid state sensors, such as split core CTs.

As a result of the field and laboratory trials feedback was provided to manufacturers, leading to improvements in their products. The product improvements made by each manufacturer are detailed in the individual product assessments section in Appendix B.

The table below outlines the overall conclusions from the assessments carried out of the products from the seven participating manufacturers. It should be pointed out here that these conclusions reflect the performance and functionality of systems tested in this trial and not necessarily of the current iteration of products.

Manufacturer	Overall Rating	NPL Test	Ease of Installation	Installation time per site (mins)	Relative Cost	Positive	Negative	Monitoring type
GMC i-Prosys	Excellent	Average	Easy	35-45	£	Plug and Play	Bulky metrology unit	Advanced
Sentec/Selex (Gridkey)	Excellent	Good	Easy	40-50	£	Plug and Play	Hard to access internal electronics	Advanced
Current	Good	Good	Easy	45-60	£££	Plug and Play	Case not fully weather proof	Advanced
PowerSense	Good	Average	Medium	60-90	££	Back up battery, robust case	Time consuming sensor connection	Advanced
Ambient	Good	Good	Easy	45-60	£££	Plug and Play	No commissioning indicators. One unit per feeder	Advanced
Haysys	Satisfactory	Average	Hard	90-100	£	Large sensor aperture	Time consuming sensor connection	Basic
Locamation	Satisfactory	Good	Easy	45-60	££	Plug and Play	Electronics prone to failure	Advanced

Table 1: Overall project conclusions for all seven manufacturers.

2. Project Overview

The following table outlines the project objectives as laid out in the registration proforma.

Project Title	LV Current Sensor Technology Evaluation
Project Background	<p>As UK distribution networks migrate to a Smarter Grid, there is an increasing requirement to improve the visibility of the Low Voltage (LV) network. There is currently limited monitoring of the low voltage distribution network and as customers change their usage habits and more renewable generation connects to the network it is imperative that we are aware of and understand the impact it will have.</p> <p>The Project Direction from Ofgem for Western Power Distribution's (WPD) Tier 2 Network Templates project resulted in a consultation with the other DNOs to see if there were alternative methods of obtaining current measurements without the need for customer interruption. The responses to this consultation were all very constructive, but there were no products identified which could adequately replace the use of fixed ring CTs in the timescales of the project. The alternatives were either too costly, or were not available in the quantities required for this project.</p> <p>UK Power Networks (UKPN) was separately investigating commercially available LV monitoring solutions that do not require customers to be interrupted during installation.</p> <p>The two DNOs decided to collaborate to evaluate a range of LV monitoring solutions under laboratory conditions at the National Physical Laboratory and in the field on their low voltage networks, equipping at total of 28 substations with sensors from 7 different manufacturers.</p>
Scope and objectives	<ol style="list-style-type: none"> 1. The project aims to evaluate innovative current sensor technologies in a controlled laboratory environment and field situations. 2. The project will evaluate sensors from 7 manufacturers and the field trials will last for 12 months. 3. The objective is to generate knowledge of LV monitoring techniques enabling wider roll-outs to facilitate a low carbon future and minimising disruption to customers. 4. A full report detailing the results of individual tests, and a comparative assessment will be produced.
Success criteria	<p>The project will be successful when:</p> <ol style="list-style-type: none"> 1. DNOs approve safe installation procedures. 2. Testing and report of lab evaluation is completed by NPL. 3. A 12 month field trial is completed. 4. A full project report has been written - evaluating and comparing sensor results from laboratory and field trials. 5. The results of the project influence DNO LV monitoring policies.

3. Details of the work carried out

This section aims to give an overview of the principle components of LV substation monitoring, the evaluation methodology used and what considerations were taken when choosing trial.

3.1. Substation Monitoring Overview

Distribution substation low voltage monitoring equipment is generally composed of a number of fundamental components to assess a range of metrics.

- Power connection – 3 phase voltage input to provide power and voltage monitoring point
- LV Sensors – Usually a current transformer or Rogowski coil to measure currents. Generally one sensor per phase per LV way.
- Interface – a unit that can take the sensor measurements and translate them into current and voltage readings.
- Central processing unit – Computing power to be able to make an initial assessment of the data collected and process for further consumption.
- Communications module – remote communications unit to send measurement for storage in a database.

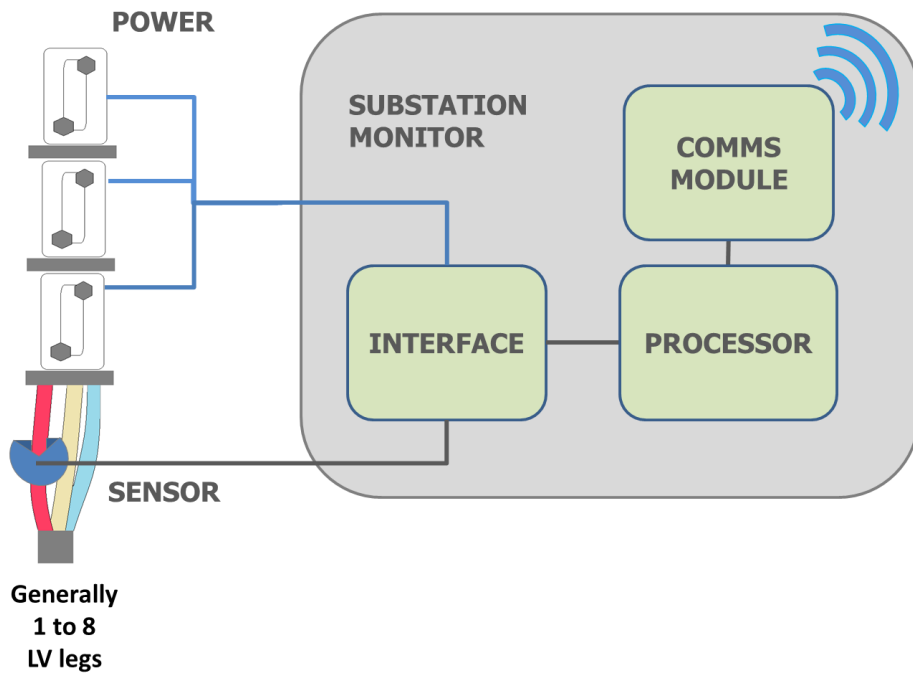

Figure 1: Fundamental components of a LV Substation Monitor.

This project was intended to test substation monitoring solutions as a whole, while paying additional attention to the current sensors being used by each manufacturer.

3.2. Method trialled

A two stage evaluation was carried out:

1) The first stage evaluation was a laboratory comparison of monitoring solutions at the National Physical Laboratory (NPL). This compared the solution's technical capabilities such as accuracy, temperature coefficient, reaction to humidity, reaction to fault current, effect of orientation and proximity to other conductors, under controlled conditions.

2) The second stage compared the monitoring solutions during a 12 month live trial. Each manufacturer equipped 4 substations, two at WPD outdoor substation sites and two further installations at UKPN indoor substations (a total of 28 substations). The live trial evaluated the engineer training required, ease of installation and maintenance, data collection, software provided, day-to-day usage and accessibility of results.

The systems provided by each manufacturer varied in their design. They ranged from full solutions (sensors, communications and software tools etc.) to sensors only with a conditioned box (amps output only). When required WPD and UKPN provided remote communication systems to enable data collection.

3.2.1. Product Selection

The sensors being evaluated were selected following a call for proposals issued through the Energy Networks Association (ENA) and Official Journal of the European Community (OJEC) notification processes. All solutions selected featured either Rogowski coils or split-core current transformers with a central processing unit and GPRS communications. The minimum measurements required were 3 phase current and voltage, total, real and reactive power and power factor.

The companies selected through the tender process were:

1. GMC i-Prosys
2. Sentec/Selex (GridKey)
3. Current Group
4. PowerSense
5. Locamation
6. Ambient
7. Haysys

One further organisation did tender for the trial, but were not taken through to the project as the equipment was significantly more expensive and required a separate monitor for each phase of each LV way.

The premise for carrying out these trials was to test out various non-invasive monitoring solutions whose installation would require no outage on the substation; thus having no impact on Customer Interruptions (CIs) and Customer Minutes Lost (CMLs). The mechanism for monitoring was the same across the solutions tested:

- A sensor was placed around the low voltage (LV) conductor to measure the current flowing through.
- An additional connection made to the LV board or pillar to obtain the voltage measurement along with the power for the monitoring unit.
- The voltage and current sensors were connected to a control box which contained the metrology and communication electronics.

3.2.2. Laboratory Tests Selection

A selection of laboratory tests were undertaken so that a comparative study could be carried out between the different monitoring solutions. For the tests, a LV sensor was fitted to a vertical conductor representative of an individual phase core of an LV cable as found in a typical secondary substation (Figure 2). Tests were made against a national standard current transformer with amplitude accuracy better than 0.01 %. Each manufacturer's equipment was tested as a complete unit to ascertain the accuracy of the system, rather than an Individual component level.



Figure 2: Laboratory test setup at NPL

The following laboratory tests were selected for carrying out this comparative study and assess the current measuring capability of the solutions

1. *Full scale amplitude accuracy and drift.* To compare the full accuracy of a sensor, a measurement was made at 500A at least 5 times with at least 1-day gaps between the measurements. These tests will be performed in a temperature-controlled environment. During this test the sensors were not be moved.
2. *Linearity.* A linearity test was performed at 1%, 5%, 10%, 20%, 30%, 50%, 75% and 100% of 500 A.
3. *Positional sensitivity.* The sensor was rotated and/or inverted depending on its shape. It was be moved around the conductor to a number of positions in order to assess its sensitivity to position.
4. *Conductor end effects.* The sensor was moved to the end of the horizontal section of the conductor to the point where the conductor bends away. The end effect was assessed.
5. *Proximity of adjacent conductors (stray fields).* The sensor was tested at a current level of 20A in the presence of a parallel vertical conductor carrying 20A, 50Hz with a phase displacement of a nominal 120 degrees. The distance between the horizontal conductors was 12 cm.
6. *Frequency Response.* The sensor amplitude frequency response was tested at 20A at several frequencies up to 2 kHz.
7. *Temperature Coefficient.* The sensor was tested at 2.5°C, 21°C, 39°C at 20A, 50Hz. This test was not performed on a vertical conductor due to the configuration of the temperature cabinet.

Many of the units tested as part of the trial featured additional functionality including temperature sensors, voltage, harmonics and neutral current measurement. None of these functions were tested as part of the NPL assessments as these were over and above the specification used for procurement.

3.2.3. Installation Site Selection

A number of factors were considered when selecting the indoor substation locations for UKPN and outdoor locations by WPD.

The UKPN sites were located in the London Power Network (LPN) area. The purpose behind selecting sites in LPN was to test out the sensors suitability for installation in brick built indoor distribution substations. Within the LPN area the selected sites were fed from Carnaby Street Primary Substation. This primary substation feeds the area in and around Leicester Square which is a highly commercialised area and has seen high load growth over the years. A number of site surveys were then carried out to short list suitable sites for

installation. The majority of sites had open LV boards or wall mounted open LV frames with 5 LV ways with some sites having their LV board extended to accommodate another transformer at site. The LV boards were either top entry (Figure 3) or bottom entry with respect to the LV cable connections. Sites identified during surveys where the gap between the individual phase cores of the LV cable was a few millimetres were discounted as it would not have been possible to place sensors, either CTs or Rogowskis, around all three cores. This was the main consideration during the selection of sites in the Carnaby Street primary substation area.

The second factor considered was the GSM (2G) signal strength in the substation as a majority were inside basements of commercial buildings. The signal strength was recorded during site surveys and used in the selection of suitable sites.

A third factor considered in the selection process was the availability of space near the LV board where the metrology unit could be placed. This would help with cable management and ensure that maximum number of LV ways can be monitored given the reach of sensor cables in some cases. There were no issues foreseen with obtaining voltage reference or power for the monitoring units as there were several options available which included the use of modified fuse carriers, Remote Terminal Unit (RTU) fuses and fused G-clamps. More detailed on these is provided in the next section.

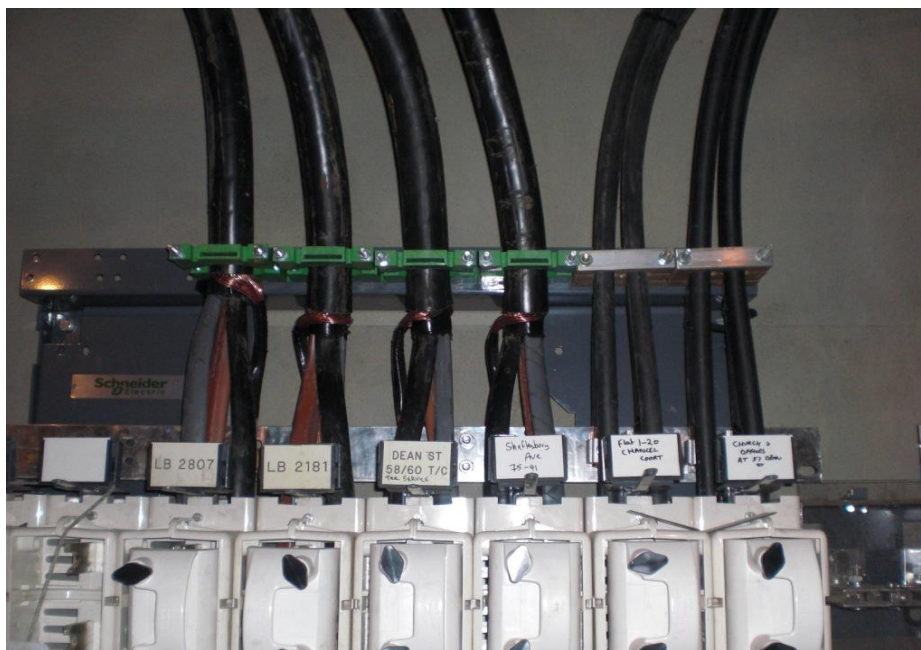

Figure 3: Top entry Schneider LV board showing separation of individual phase cores. (UKPN)

For the purposes of the WPD trial, detailed site surveys were conducted to establish appropriate locations in Market Harborough. This included sites with a maximum of 5 LV feeders, in either outdoor compounds or GRP housings. A number of sites were discounted

due to the makeup of the LV pillar. The example below (Figure 4) which is quite common, was deemed unsuitable for a range of reasons.



Figure 4: LV cast iron cabinet with compound filled tiered cable terminations.

Firstly, there were 6 LV feeder ways and while some manufacturers could accommodate this scale, it would have required modification. Modifications of the monitoring equipment were outside the scope of the trial, so sites with 6 or more LV feeder ways were discounted. Secondly, the cabinet was constructed out of cast iron and set on a solid brick plinth. This presented a problem in getting cables out of the cabinet to the control box. It is recognised that for a wider deployment this could be achieved by excavating around the pillar and bringing cables out of the base of the unit. However for the purposes of the trial it presented additional challenges that could be avoided by a different site choice. Where possible, sites were chosen where existing openings were available to allow sensor cables to be fed out of the cabinet without the need for creating additional holes.

One further consideration was the cable terminations. In this case, as the cable enters the pillar it is terminated in a metal compound filled tiered box as shown in Figure 5. This meant that it was not possible to access the cable cores and therefore the LV sensors could not be installed around the conductors. If monitoring was required at this pillar it could be achieved using a flexible Rogowski coil, either around the transformer links to gain a whole substation view, or around the fuse carrier handles if a feeder by feeder view was required. However it is recognised that this presents further operational challenges as the each coil would need to be removed should the fuses require removal. The following photos show a tiered box with enclosed cores (Figure 5), and a more open termination with each core accessible (Figure 6).

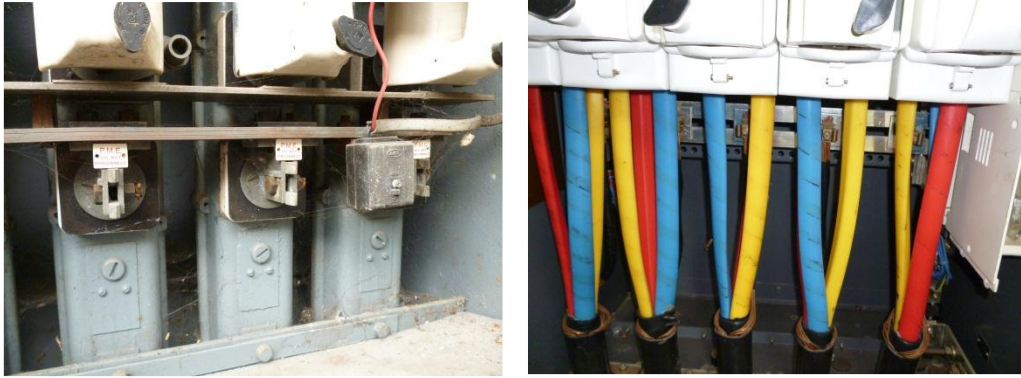

Figure 5 & 6: Tiered cable termination (left) and accessible individual cores (right).

3.2.4. Safe Installation Procedure

Before installation of equipment could begin a safe system of working and installation had to be developed. In order to do this each manufacturer was invited to the UK Power Networks training centre, located at Sundridge, and asked to bring one complete unit consisting of sensors, metrology unit and accessories. The manufacturers demonstrated the installation and commissioning procedure to representatives from both DNOs. The representatives included the project managers, the installation personnel and a health of safety advisor. Mock installation of the sensors were carried out in indoor and outdoor substations which were part of the training network. This was done to highlight any potential issues that could be encountered during installation.

Additional precautions had to be taken when installing CTs based sensors, especially in variants with the lack of a shorting pin between the CT terminals. The CTs had to be connected to the metrology unit before being installed on the LV board or pillar to prevent a dangerous voltage appearing between the terminal wires of the CT. This could cause damage to the device and lead to the risk of an electric shock to the installer.

As a result of these meetings and further discussions with manufacturers installation policies were developed and approved. An example installation policy can be found in Appendix C. Before the installations could begin, field staff were provided with a Work Method Statement along with specific task instruction sheets for each site. Once installations were complete, local operational staff were made aware of the installations and contact details left at each site should further information be required. All safe working procedures as laid out in the DNO Distribution Safety Rules (DSR) and operational policies were followed during the installations.

3.2.5. Voltage Connections

For each manufacturer a 3 phase voltage connection was required to allow monitoring of the voltage on the live busbars while a single phase connection was sufficient to power the unit. A range of solutions had to be developed, primarily driven by the design of cabinet, but

also by operational requirements. The aim was to keep the interaction with daily operations down to a minimum by not impeding the removal of fuse carrier handles. The following order of preference was therefore developed for WPD and UKPN.

1. Use of existing voltage reference points (RTU power source/ Test point- Figure 7)
2. Approved Insulated busbar G clamps (with inline fuse – Figures 9 and 10)
3. Modified fuse carrier handles on a spare LV Leg (Figure 11)
4. Modified fuse carrier handles on a live LV Leg

A number of pillars and LV cabinets have existing voltage test points which can be utilised to provide power and a voltage reference point for testing. These can be utilised to provide a three phase reference point and supply voltage for the cabinets. In some of the newer package substations, this will be a test block with live terminals. Older pillars (such as the one pictured in Figure 7 below) provide an alternative take off point that can be utilised. This required some modifications to the monitoring power leads. Where test points are present, it is recommended that a check is made during the pre-installation surveys to ensure that the terminals are live.



Figure 7: LV Cabinet with 3 phase test point

In a number of sites, the LV pillar / board will have exposed busbars that can be utilised to get a voltage reference. If terminals are not available, an approved nylon voltage clamp can be utilised with the appropriate fused leads. The following photograph (Figure 8) shows an open pillar where the voltage clamp may be appropriate. In this scenario it would be recommended to install the clamps to the side of the end set of fuses, so as not to interfere with any future operations on the boards.



Figure 8: LV Cabinet with open busbar design

There are a number of voltage clamps which can be attached over the top of the busbars and tightened using an approved tool or integral screw. Prior to install a risk assessment should be made as to whether the clamps can be installed safely. Particular consideration should be made as to the location on insulated phase barriers and access to the bars. Full PPE should be worn for such activity in accordance with Distribution Safety Rules.



Figure 9 & 10: Voltage clamps manufactured by 1047 (left) and Martindale (right)

Should none of the above methods prove practicable, an alternative method is to replace a fuse carrier handle with a modified Schneider unit with a voltage terminal (Figure 11). These replacement fuse holders are ideal for enclosed boards although special consideration should be made as to their location. The disadvantage with such a solution is that trailing leads will be left down the front of the board and these will require unplugging before any operations can take place on that cable leg. Where possible, a spare leg should be utilised and the voltage take off point kept at the top to give a voltage for the bus bar. At present, these replacement carriers are only available for JS fuses with 3 5/8" spacing. Where a spare LV leg is not available, an alternative leg can be back fed, the fuse carriers replaced and the back feed removed.



Figure 11: Modified fuse carrier handles installed on spare leg in pillar

3.2.6. Data Transmission

Data from the metrology units was transmitted back to each manufacturer's database via GPRS. The majority of manufacturers used the widely adopted DNP3 protocol to transmit data over GPRS while some used their own proprietary protocol. The majority of manufacturers provided their own SIM cards for the trial with the exception of PowerSense and Locamation for whom the SIM cards were provided by the DNOs. The data transmitted from each unit was accessible via the manufacturer's own proprietary web based data visualisation portal.

For the purpose of this project any data integration activity was discounted due to the effort and cost required to integrate data from 7 different manufacturer's equipment into each DNO's own database. This activity would have been considered for a much larger roll out of monitoring equipment from one single manufacturer.

4. The Outcomes of the Project

This section outlines the findings of both the laboratory and field trials for each of the monitoring solutions tested. While the principles used to install the equipment has not varied much between vendors, the practicalities, ergonomics, functionality and reliability of equipment vary from one solution to another. Detailed results from the laboratory testing can be found in the NPL report (Appendix A), with a detailed company by company assessment of equipment in Appendix B.

As a market, substation monitoring equipment is evolving at a rapid pace. In less than 3 years, some high specification, lower cost units have been developed by a range of companies. This pace of change is continuing with new models and functions becoming available all the time. While each of the manufacturers involved have made improvements to the equipment in response to the learning demonstrated through this project, it should be stressed that the results and conclusion published in this paper are based upon the versions of equipment supplied in July 2012 for the purpose of the trial. Additional information is presented on the developments that have been made by each manufacturer in Appendix B. For details of current equipment specifications, vendors can be contacted directly.

4.1. Monitoring solution measurement capability comparison

Through the tender process, the focus was to procure a replacement for a fixed-ring CT solution, with the ability to measure total LV substation demand for a three phase transformer. In addition the sensors were to be capable of being fitted without the need for an interruption to electricity supplies, of accuracy class 0.5S or better and able to be fitted to a range of LV boards. What the project did not specify was the functionality of any accompanying metrology unit other than the use of GPRS communications.

Subsequently, the range of solutions that were proposed for the project was varied and included some advanced functionalities such as harmonic monitoring, system alarms and temperature measurement. These were not tested as part of the project as they were deemed to be over and above the core current measuring specification that was requested in the project, but demonstrates functionality that is becoming more common with such solutions. The functionalities of the solutions trialled are summarised in table 2.

While communications have not been tested in this scheme, it is worth noting that many of the units included an Ethernet communications port that would allow the connection of additional communications options such as radio, internet, or wired links.

LV SENSORS

	LV Ways Per System	Maximum LV ways in a single unit	3 Phase Current (A)	3 Phase Voltage (V)	S (kVA)	P (kW)	Q (kVar)	Power Factor	Neutral Current	Frequency (hz)	Temperature Sensor	THD Current	THD Voltage	Fundamental Harmonics	Configurable Alarms	Alarms	Battery	Ethernet Comms Port	Minimum Reporting Resolution	Solid State Data Storage
Gridkey	5	5	✓	✓	✓	✓	✓	✓	✓	✓	Internal sensor	✓	✓	-	✓	All parameters programmable	-	✓	1 min	✓
GMC i-Prosys / Nortech	4	9	✓	✓	✓	✓	✓	✓	✓	✓	2 - 1 x ambient and 1 x patch	✓	✓	Up to 21st	✓	Threshold alarms on a range of parameters	-	✓	1 sec	✓
Current	4	6	✓	✓	✓	✓	✓	✓	✓	✓	1 per LV Way	✓	✓	Up to 50th	✓	All data types set as % change or absolute values.	20 sec last gasp	✓	100ms	✓
Ambient	1	1	✓	✓	✓	✓	✓	✓	-	-	-	✓	✓	Up to 50th	✓	All parameters programmable	Optional	✓	1 min	✓
Haysys	4	16	✓	✓	✓	✓	✓	✓	-	-	Up to 8 probes	✓	✓	Can be calculated	✓	All parameters programmable	Optional	✓	1s	✓
Powersense	4	8	✓	✓	✓	✓	✓	✓	-	✓	Up To 4	✓	✓	Up to 50th	✓	Under / Overvoltage No volts Over Current Blown Fuse Health	8 Hours +	✓	200ms	✓
Locamation	5	5	✓	✓	✓	✓	✓	✓	-	-	-	✓	✓	Up to 25th	✓	All parameters programmable	-	-	Continuous	✓

Table 2 – Functionality of tested solutions

What became apparent through this trial is that the functionality available from these off-the-shelf monitoring solutions is becoming increasingly advanced and in many cases in line with what could be expected from power quality monitoring devices. Many units are now capable of assessing total harmonic distortion and individual fundamental harmonics. Additional flexibility is also provided with some units catering for battery backup, temperature probes and in some cases the ability to monitor neutral currents.

While specific product costs cannot be disclosed due to commercial sensitivity, a relative cost comparison has been included in Table 6. It is recognised that in a wider deployment, economies of scale could be gained from the purchase of larger quantities. In addition the costs incurred within the project are skewed by software licencing, while in a full procurement the total cost of ownership should also be reflected by considering the installation and on-going running costs. This project was not conducted at a scale that would allow a fair reflection of actual cost, especially in light of the on-going developments in the market. Therefore no conclusions should be drawn on this indication.

Another area that has not been considered during the testing is that of system earthing. In a number of substation sites, significant rises in potential can be experienced on the earth in the event of a fault. The “hot sites”¹ require separation of the site earth and neutral. Where a metal cases unit would be utilised it would have both a connection to the site earth and neutral. No testing has been completed as part of this trial to evaluate what would occur to a unit in the event of a fault. It is therefore recommended that further risk assessments are carried out by DNOs facing this situation.

4.2. NPL laboratory testing summary

As detailed in section 3.2.2, a range of laboratory tests were undertaken to assess the accuracy of current measurements in a range of scenarios. NPL have produced a detailed report that outlines the findings from the entire laboratory testing which is included in Appendix A of this document.

The following table outlines the specification of the individual sensors tested including the resolution of current measurement and the size of the sensor aperture. This represents the maximum diameter of cable that the sensor could be attached around. It was generally found that the flexible Rogowski sensors were the easiest to connect and remove, with a couple of the solid sensors proving more difficult to use. This assessment was based on laboratory experience only where the sensors were attached and removed with great regularity. Further findings on the practicality of each of the sensors can be found later in this document and in Appendix B.

¹ If the earth potential rise is greater than 430V, a Secondary substation is designated a Hot Site.

Characteristics of Sensors						
Manufacturer	Sensor In NPL Report	Resolution (A)	Rated Current (A)	Approximate Aperture Size (cm)	Flexible or Solid Sensor	Ease of connect /reconnect
Ambient	Sensor A	±0.001	600	3	Solid	Difficult
Current	Sensor B	±0.001	Not Marked	5	Solid	Easy
Haysys	Sensor C	±0.1	Not Marked	14	Flexible	Easy
GMC i-Proslys	Sensor D	±0.01	Not Marked	7.5	Flexible	Easy
Locamation	Sensor E	±0.001	600	3.5	Solid	OK
PowerSense	Sensor F	±1	600	5	Solid	Difficult
Sentec/Selex (Gridkey)	Sensor G	±0.01	600	2.5	Solid	OK

Table 3: Sensor characteristics

Some of the initially scoped out laboratory tests were not carried out:

- For the linearity test it was envisioned that an assessment of the hysteresis performance would be carried out but it was later concluded that this was not necessary as the repeatability of the sensors at all levels was good.
- For the conductor end effects test, the conductor orientation was initially going to be vertical, as you would find in distribution substations, but it was later decided that for ease of testing a horizontal conductor would be used as it was not easily possible to position the sensor accurately at the 3 positions on a vertical bus bar.
- For the stray fields test it was initially scoped to test at current levels of 5% and 100% of 500A in the presence of another conductor carrying 500A but it was later decided that 20A flowing in both conductors was sufficient to study the effects of stray fields and a typical conductor spacing of 12 cm as found in LV cabinets and pillars would be used.
- Finally, for the temperature coefficient test, it was later decided to test in temperatures of 2.5°C, 21°C and 39°C to see the impact on sensor operation in low, medium and high temperatures that could be experience in substations as opposed to the initially chosen temperatures of 10°C, 20°C and 30°C. Due to restrictions with the temperature cabinet, 2.5°C and 39°C were the 2 extremes possible. Due to time constraints, 21°C was chosen being equivalent to the laboratory temperature used for all of the other tests.

While a range of tests were undertaken, the linearity tests were of particular interest. These demonstrated the ability of the systems to measure known currents across a range of common operating currents as found in many UK substations. The findings from these tests are summaries in tables 4 and 5.

Accuracy and Linearity Tests							
Nominal Applied Current	Current Reading						
	Sensor A Ambient	Sensor B Current	Sensor C Haysys	Sensor D GMC i_Prosys	Sensor E Locamation	Sensor F Powersense	Sensor G Gridkey
(A)	(A)	(A)	(A)	(A)	(A)	(A)	(A)
5		5.113		4.89	4.999	4	4.91
25	24.531	24.984	24.7	24.63	24.970	24	24.88
50	49.469	49.953	49.1	49.05	49.939	49	49.76
100	99.594	99.889	97.8	98.05	99.796	99	99.52
150	149.791	149.821	146.8	147.03	149.687	149	149.29
250	250.483	249.712	244.8	244.72	249.489	249	248.93
375	377.352	374.675	367.0	366.87	374.213	373	373.47
500	504.436	499.756	489.6	488.24	498.893	498	498.67

Table 4: Accuracy and Linearity Test Results from NPL report (Table 1)

Table 1a - Error, % of Nominal Applied Current							
Nominal Applied Current	Current Reading						
	Sensor A	Sensor B	Sensor C	Sensor D	Sensor E	Sensor F	Sensor G
(A)	(%)	(%)	(%)	(%)	(%)	(%)	(%)
5		2.251		-2.26	-0.020	-19	-1.89
25	-1.877	-0.062	-1.2	-1.47	-0.118	-4	-0.50
50	-1.063	-0.094	-1.9	-1.90	-0.122	-2	-0.47
100	-0.406	-0.111	-2.2	-1.95	-0.204	-1	-0.48
150	-0.139	-0.120	-2.1	-1.98	-0.209	-1	-0.47
250	0.193	-0.115	-2.1	-2.11	-0.204	-1	-0.43
375	0.627	-0.087	-2.1	-2.17	-0.210	0	-0.41
500	0.887	-0.049	-2.1	-2.35	-0.221	0	-0.27

Table 5: Error % Accuracy and Linearity Test Results from NPL report (Table 1a)

Sensor F (Powersense) had a number of accuracy issues at lower currents, although this was generally attributed to the resolution of the monitoring unit. As the design was based on a split core CT, the accuracy generally improved as the current increased. Sensors C (Haysys) and D (GMC i-Prosys) were both flexible Rogowski coil designs. It can be concluded from these results that this design of sensor will generally provide accuracy in the region of 2% through the range of currents tested.

The laboratory results showed that the solutions provided by Current and Locamation proved to be the most accurate across the range of tests, with good performances from the Gridkey and Ambient sensors.

4.3. Installation Experience

During the 28 installations, it became clear that a number of practical considerations in the designs would have a bearing on the simplicity and practicality of installation. This included the size of the units, cable terminations, and sensor design.

Several solutions featured plug in or screw in fittings, allowing a simple attachment of the sensors to the monitoring unit. This significantly reduced the installation time compared with sensors provided with bare ended cables, and also reduced the chance of connection error. The best solutions were provided by GMC-iProslys and Locamation where by sensors were grouped into one connector for each LV way, meaning that sensors could be connected in under 5 minutes. In contrast, one solution took over an hour to wire in individual sensors, as cables required extending and bare ends each were attached to a wiring loom.

During installations it became clear that flexibility was important and that no manufacturer had a one size fits all solution. Some manufacturers therefore offered sensors with a range of cable lengths and in some cases sensor types. This was particularly important and in some cases the monitoring unit had to be placed 4-5m from the LV board due to space restrictions.

The design of the sensor also had a bearing on the ease of installation. While not the most accurate in the laboratory tests, the flexible Rogowski coils proved to be the easiest to install. Some of the more rigid sensors were at times difficult to install due to the diameter of cables and spacing between cable cores. This was a particular problem with some of the more bulky sensors such as the Ambient sensor, and split core CT design from Locamation. Current provided both a flexible and solid sensor, which allowed some additional flexibility, although it was considered that the solid sensor was extremely bulky and difficult to connect in tight spaces. A number of manufacturers have now recognised the limitations of solid sensors and offer both solid and flexible sensor types. There is however a trade-off between installation ease and accuracy as the laboratory tests have shown.

The trials were conducted in both indoor and outdoor substations, to represent the full range of ground mounted substations found in the UK. Most monitoring units came in metal or plastic housings that were appropriate for both indoor and outdoor applications, with the exception of monitors by Current. The Current monitoring units were housed in aluminium cases with open vents at the back, which would easily allow moisture into the case. For outdoor applications, these would need to be housed in additional enclosures to prevent damage from the elements. From a practical perspective, plastic housings offered the greatest flexibility due to the non-conductive nature of the material. For example, it was possible to install the Gridkey unit inside an LV cabinet as the unit was extremely shallow and plastic.

From a commissioning perspective, a number of units featured indicator lights to confirm correct installation and setup. The best examples of these were provided by Gridkey and Powersense. An additional cover was also provided by Gridkey, to cover indication lights once installation was completed. Units provided by Ambient featured no indication and the correct installation could only be confirmed by checking to see if the units had registered with the server.

Cases for the monitoring units came in either metal or plastic. From a practical perspective, plastic housings offered the greatest flexibility due to the non-conductive nature of the material. For

example, it was possible to install the Gridkey unit inside an LV cabinet as the unit was extremely shallow and plastic.

4.4. Overall Product Conclusion

The following table summarises the findings from both the field and laboratory testing for all the monitoring solutions assessed as part of the trial.

Manufacturer	Overall Rating	NPL Test	Ease of Installation	Installation time per site (mins)	Relative Cost	Positive	Negative	Monitoring type
GMC i-Proslys	Excellent	Average	Easy	35-45	£	Plug and Play	Bulky metrology unit	Advanced
Sentec/Selex (Gridkey)	Excellent	Good	Easy	40-50	£	Plug and Play	Hard to access internal electronics	Advanced
Current	Good	Good	Easy	45-60	£££	Plug and Play	Case not fully weather proof	Advanced
PowerSense	Good	Average	Medium	60-90	££	Back up battery, robust case	Time consuming sensor connection	Advanced
Ambient	Good	Good	Easy	45-60	£££	Plug and Play	No commissioning indicators. One unit per feeder	Advanced
Haysys	Satisfactory	Average	Hard	90-100	£	Large sensor aperture	Time consuming sensor connection	Basic
Locamation	Satisfactory	Good	Easy	45-60	££	Plug and Play	Electronics prone to failure	Advanced

Table 6: Product Conclusions

Taking all elements into consideration the GMC i-Proslys and Gridkey units proved to be the best units tested. In both cases they proved easy to install, reliable and met the required standards in the laboratory testing.

Since this trial started, further developments have taken place with all products tested, and further details of the improvements can be found in Appendix B.

5. Performance compared with Project aims, objectives and success criteria

This joint UKPN and WPD Tier 1 project has successfully demonstrated the safe and relatively inexpensive installation of LV monitoring equipment in typical Distribution Substations. The project has also demonstrated the measurement capability of the monitoring solutions in tests against different measurement parameters in a laboratory environment.

The performance against the original aims and objectives is summarised below:

Project Aims and Objectives	Comments
The project aims to evaluate innovative current sensor technologies in a controlled laboratory environment and field situations.	<p>The monitoring equipment provided by seven different manufacturers was successfully evaluated in both a controlled laboratory and field environment.</p> <p>A range of sensors based on Current Transformer and Rogowski coil technologies were tested along with the metrology units provided. A safe installation policy and report detailing the test results have been written.</p>
The project will evaluate sensors from 7 manufacturers and the field trials will last for 12 months.	The field installations were started in July 2012 as opposed to April 2012 due to unavailability of the DNO training centres to carry out installation training. A number of devices have therefore been in place for the 12 month. Those in UKPN were started and completed in February 2013 due to the delay in approval of the installation policy and unavailability of field staff. However it is considered that the core learning associated with functionality and installation practice has been gathered within this shorter timeframe.
The objective is to generate knowledge of LV monitoring techniques enabling wider roll-outs to facilitate a low carbon future and minimising disruption to customers.	<p>Significant learning was generated through the installation of different monitoring technologies on the diverse networks of Britain's two largest DNOs. Different installations scenarios were encountered and the close down report expands on these. This will allow the DNOs to prepare for a wider roll out of monitoring equipment. Learning has also been generated through the laboratory testing of these technologies which will allow the manufacturers to improve their products further.</p> <p>Also, any further innovation projects involving the installation of LV monitoring equipment or business as usual larger roll-out will be able to use the learning from this project.</p>
A full report detailing the results of individual tests and a comparative assessment will be produced.	Following the successful completion of laboratory tests by NPL a report has been prepared expanding on the individual performance of the sensors along with a comparative assessment. This is included in Appendix A

The performance against the original success criteria is summarised below:

Project Success Criteria	Comments
DNOs approve safe installation procedures.	Each monitoring solution manufacturer demonstrated the installation and operation of their equipment to the DNOs at the UK Power Networks Sundridge Training Centre. The learning from these meetings was incorporated into a comprehensive policy that UK Power Networks wrote on the installation of LV monitoring equipment in distribution substations. It was approved by the different business departments and shared with Western Power Distribution. A copy of this can be found in Appendix C. WPD have also developed a number of installation guides and draft policy which is currently being developed for business as usual application.
Testing and report of lab evaluation is completed by NPL.	<p>The manufacturers of monitoring equipment delivered three sensors and a metrology unit to NPL while WPD delivered the LV cabinet that would act as the test bench. Some modifications had to be made to the LV cabinet before it was suitable for testing the sensors.</p> <p>This led to a delay in the start of the tests. Once the modifications had been implemented the tests agreed were completed for the majority of sensors. Some tests could not be conducted on a few sensors due to either the size of their aperture or their measurement resolution. The report detailing the test results has been written by NPL and approved by both DNOs (see Appendix A).</p>
A 12 month field trial is completed.	There was a delay in the start of the field installations as the installation training sessions could not be conducted due to non-availability of the DNO training centres. Once the training of installation staff was completed in three sessions spread over June and July 2012, at the UKPN training centre in Sundridge the installations commenced. WPD started installation work in July 2012, completing all the installations by October 2012. The UKPN installations were completed in February 2013. UKPN had to wait for the installation policy to be approved before any installations could be carried out and this led to a further delay in their installations.
A full project report has been written - evaluating and comparing sensor results from laboratory and field trials.	This close down report along with the NPL testing report have been completed.

Project Success Criteria	Comments
The results of the project influence DNO LV monitoring policies.	<p>The learning from the project will be disseminated internally and externally via learning events such as the LCNF conference (Brighton, November 2013), and through other events such as the LV Monitoring Knowledge Sharing event run at the National Space Centre in July 2013 by WPD.</p> <p>UKPN are currently developing a Remote Terminal Unit specification for substation monitoring and the learning from the project will feed into that specification.</p>

6. Required modifications to the planned approach during the Project

Two modifications were made to the approach of the project during the duration of the project. As part of the project governance, internal change mandates were completed. These can be found in Appendix D

6.1. Success Criteria - 12 month field trial period.

One of the project success criteria was to carry out a 12 months field trial . The installations could not be started until July 2012 because of the delay in finding suitable dates at the DNO training centres to hold the installation training sessions. This meant that only some of the equipment was installed for the full 12 month. WPD successfully completed their installations by October 2012 which meant that the field trial actually lasted for only 10 months for some units. With a number of WPD's monitoring equipment installed in outdoor substations it was envisaged that 10 months would be a sufficient time period to assess the equipment's performance in outdoor conditions where they would be exposed to the elements. The challenge of the UKPN installations was around the installation of sensors around the LV cable cores due to limited spacing between them. The main learning from those installations related to the type of sensors and different types of LV boards found in indoor brick built substations and outdoor substations with LV cabinets or pillars. It is considered that the delay in the UKPN installations did not affect the overall learning from the project.

6.2. Change of LV Sensors.

At the time of the installation training, all the manufacturers were given a chance to demonstrate their product. It came to the attention of the DNOs that a number of sensors which were being tested by NPL might not be suitable for installation on either live LV equipment due to the safety risk they presented, or there would not be sufficient space to fit them around the cable cores (this point was more relevant for UKPN's substations). In particular, one design of CT featured an exposed metal split core that was held in place with a rubber strap. This was deemed to be unsafe due to the exposed parts and insecure fitting methodology. The manufacturers who were informed of the DNOs concerns were able to provide alternatives especially where the sensor presented a safety risk.

7. Significant variance in expected costs and benefits

7.1. Project cost and variance

Cost Item	UKPN Predicted (£k)	UKPN Actual (£k)	WPD Predicted (£k)	WPD Actual (£k)	Total Predicted (£k)	Total Actual (£k)	Variance (£k)	Variance (%)
Equipment Cost	100.0	76.4	100.0	76.6	200.0	153.0	47.0	23%
Project Management and Installation	99.4	26.2	99.4	28.3	198.8	54.5	144.3	73%
NPL testing and report	34.2	17.1	34.2	17.1	68.4	34.2	34.2	50%
Total	233.6	119.7	233.6	122.1	467.2	241.8	225.4	48%

Table 7: Project cost and variances.

When the project was initially developed, costs were estimated based on prior experience from other Tier 1 and Tier 2 project with elements of monitoring. The tender process revealed off-the-shelf solutions that were at a lower price than initially anticipated. In addition, live installations practices significantly reduced the installation and project management costs. These two factors account for the significant level of underspend on the project.

7.2. Project benefits

The project has resulted in a number of key benefits to all parties involved. From a DNO perspective, UKPN and WPD have developed a detailed knowledge of some of the challenges faced when deploying substation monitoring across a number of sites. This has led to the development of policies that will allow further installations to be completed. It has also allowed greater knowledge regarding the required specification of equipment, and will support future procurement processes.

The laboratory testing has allowed increased confidence around the level of accuracy available for current measurement. It is generally considered that all the solutions tested were able to produce a satisfactory level of measurement on site.

A further benefit from the project has been the feedback loop created by the project to the suppliers. The practical learning from the installations has led to all manufacturers making improvements to their systems in response to feedback from the project. This has allowed the market to continue to develop, while increasing competition and choice.

7.3. Financial Benefits

The financial benefits that could be realised would come from the wider roll out of monitoring equipment, and the use of the data to make smarter network reconfiguration or reinforcement decisions. There would also be financial benefits for customers as a better visibility of the LV network would allow the connection of additional Distributed Generation without the need for reinforcement. The extent of financial benefits would depend upon the scale of a roll out by DNOs.

8. Lessons learnt for future Projects

8.1. LV Monitoring Products

The project demonstrated that there are now a number of commercially available LV monitoring solutions which meet the DNO requirements. This shows that manufacturers understand the DNO requirements more and more around LV monitoring and are responding by developing a wide range of solutions. The project also showed that manufacturers were willing to develop their products further in order to increase their flexibility and suitability to overcome any installation constraints that could be encountered at site. The manufacturers also learnt about the technical performance of their equipment via the laboratory test conducted by NPL. This will help them to further improve their products.

8.2. LV Sensor Safe Installation Procedure

This project demonstrated that it is possible to safely retrofit monitoring equipment on live LV board, LV cabinets and pillars. A safe installation procedure was produced by UKPN and shared with WPD to enable wider roll out of monitoring equipment.

8.3. Communication

The communication method adopted for this project was GPRS. Due to the diverse landscape of the GB DNOs, it was concluded that the reach of GPRS/3G/4G would be limited in certain situations and this would mean using other communication technologies to bring back the data. For example in cases where the substations are located indoor in basements the mobile signal strength would be weak and would require a BT line or Power Line Communications to be used. It was also concluded that to allow the DNO to easily integrate the equipment into their SCADA system, the manufacturers should adopt communications protocols that would allow interoperability across different hardware (e.g. IEC 61850).

8.4. Large Scale Deployment

The project has shown that it is possible to monitor individual LV ways in a distribution substation without interrupting customers paving the way for wide scale roll out of monitoring equipment at the LV voltage level. Further Tier 2 projects being planned by DNO involving LV monitoring would be able to use the installation policy and lessons learnt in the close down report to plan out their installations.

The manufacturer equipment, which has further developed over the course of the project, would now be available to DNOs for use in their business as usual processes.

8.5. Dissemination

UKPN and WPD along with NPL held meetings with the manufacturers before the end of the project to disseminate the learning from the testing and installations to help them improve their products.

Some manufacturers demonstrated how they had improved their products after taking on initial feedback at the installation training sessions at Sundridge Training Centre.

UKPN have also carried out an internal dissemination meeting to share lessons learnt with the Future Network, Operational Telecommunications, Network Strategy and Engineering Standards departments, which was well received.

WPD hosted a substation monitoring knowledge sharing event on 11th July 2013 at the National Space Centre in Leicester. The day shared learning from six LCNF projects, but in particular the LV Sensor Evaluation trial. The day was attended by over 80 people, with representatives from universities, vendors, DNOs, government and blue chip organisations. Ten companies exhibited substation monitoring equipment, including the seven organisations taking part in this trial. This was seen as a key opportunity to share the practical learning from this trial, while providing a hands-on experience with some of the commercially available solutions on the market.

8.6. Intellectual property

The project trialled existing commercially available monitoring products and did not look to change their main functionality or their configuration. No relevant Foreground Intellectual Property (IP) has been generated for the project.

The knowledge creation from this project is around solution requirement, safe retrofit installation, operation and communication of LV monitoring equipment. Through this project manufacturers were able to better understand the DNO requirements for LV monitoring equipment. Learning to allow other GB DNOs to replicate this project is set out in this close-down report

8.7. Laboratory Testing

When the project was initially scoped, LV substation monitoring was in its infancy. As the procurement process progressed, it became apparent that the equipment being supplied was generally of a higher specification and functionality than expected. The testing schedule that was drawn up at NPL focused on a small number of tests around current and frequency.

Should this project be repeated, it is suggested that there should be additional laboratory tests undertaken with modifications to some of the methods applied.

In particular it is suggested that tests could be undertaken to look at some of the core electrical and power quality measurements, such as voltage accuracy and aspects related to harmonics.

In addition, tests made to examine the effects of stray fields that should be modified if repeated. Following further review, it is considered that method utilised did not fully replicate the circumstances faced in a typical LV cabinet. In field installations the spacing of conductors with different phase angles can be barely a few mm, whereas the laboratory test undertaken to replicate this used a much larger spacing. In addition the 20A used for the test is generally much lower than the average current carried by cables in live substations.

8.8. Data

The project aims were specifically focused on examining the available hardware, installation processes and system accuracy. However, a significant amount of data has been collected from the 28 test sites. Further analysis has shown that the sites monitored are performing within expected boundaries, and no major network performance issues exist.

The load profile on Figure 12 is typical of some of the sites monitored serving primarily domestic areas, with a peak at 6pm in the evening and at 8 am in the morning.

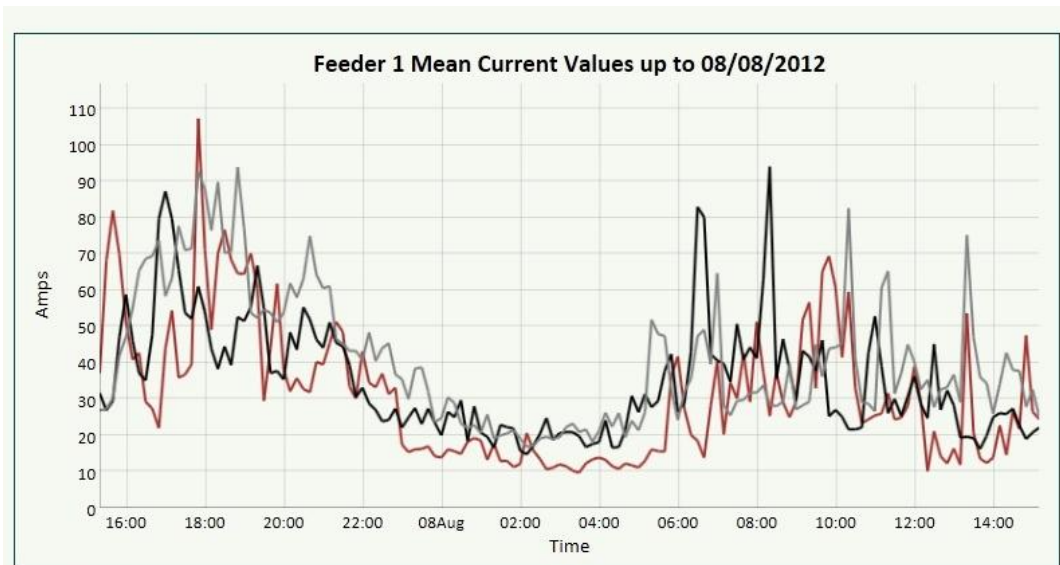

Fig 12 – Typical Load Profile – Ritchie Gdns (WPD) -Gridkey

The voltage profile for the site (Figure 13) also demonstrated that the site was operating within the expected statutory voltage limits.

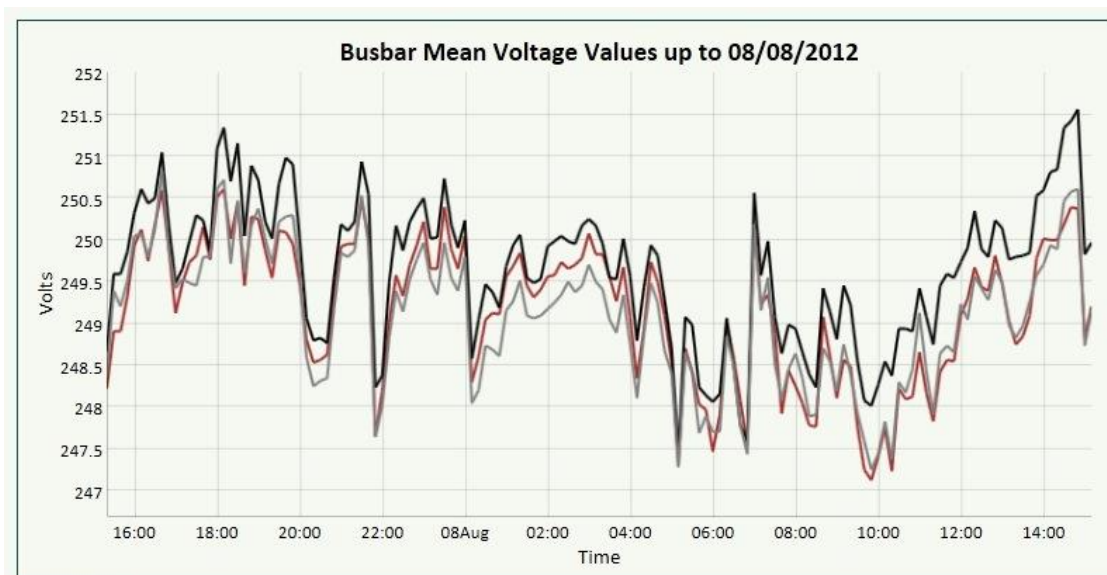

Fig 13 – Typical voltage profile – Ritchie Gdns (WPD) –Gridkey

One thing the monitoring of this site did identify was the presence of relatively large neutral currents (Figure 14). This is primarily due to imbalance in the loading on the individual phases on the network. While not posing a significant operational risk, it does contribute to the system losses experienced in the area.

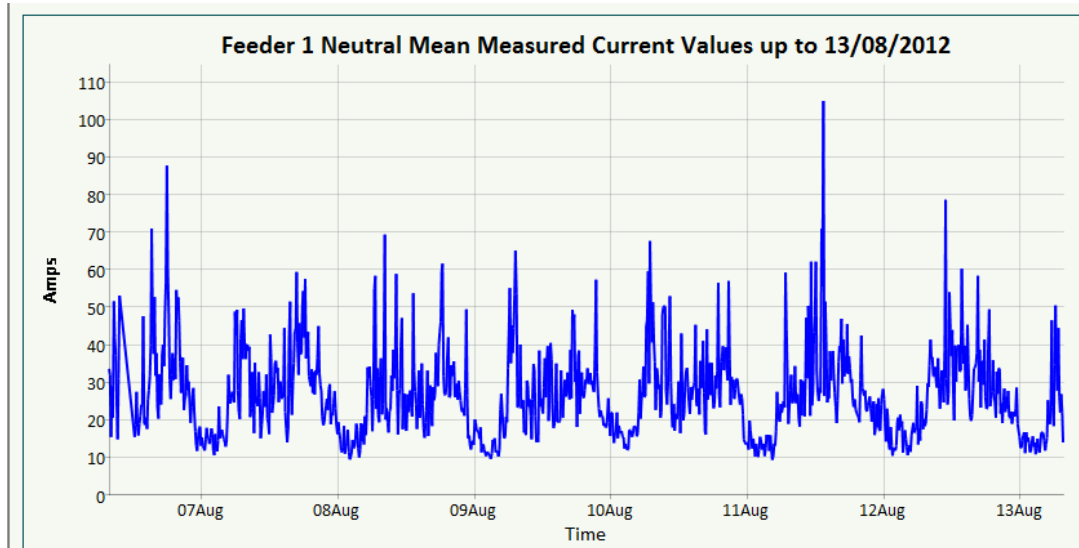

Fig 14 – Neutral Current from network imbalance – Ritchie Gdns (WPD) -Gridkey

Given that for the majority of the time substations operate within expected parameters, they still produce large amounts of data while being monitored. This has led to the development of a number of analytical tools to help visualise data. Figure 15 outlines the load duration for the Dean Street Substation(UKPN). This summarisation of data shows, not only that the site is not overloaded, but also how heavily loaded the site is and for what percentage of time.

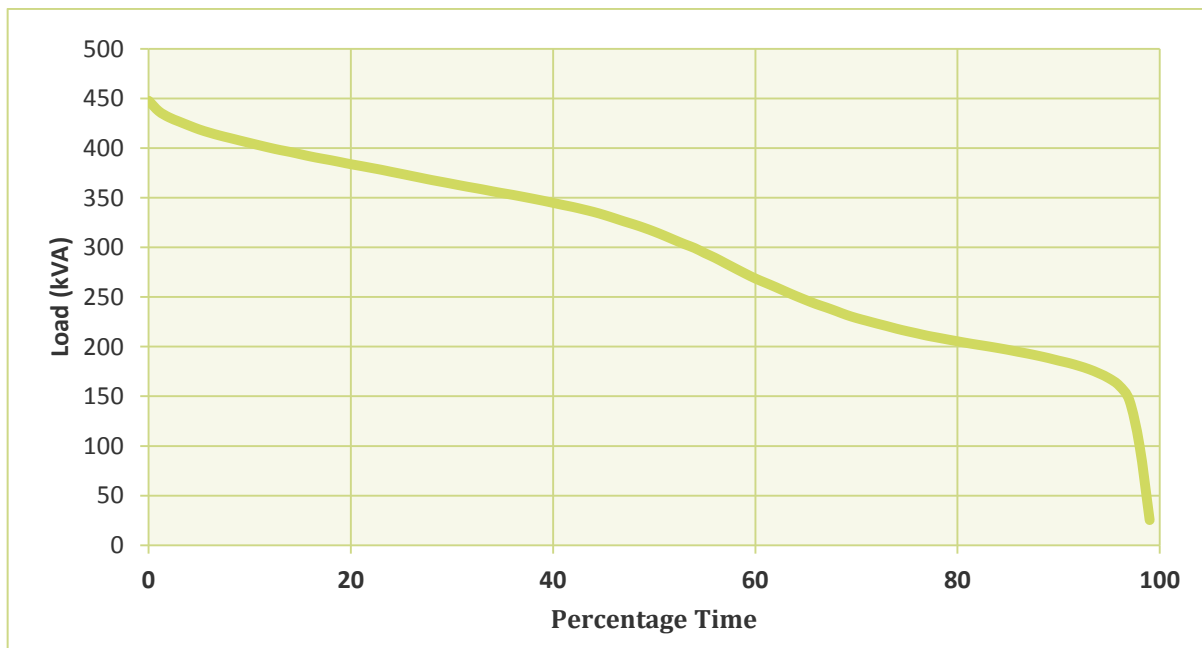

Fig 15 – Load Duration Curve –Dean Street (UKPN) – GMC-iProslys / Nortech

Another important factor is being able to pin-point anomalies that may occur in small time bands. Simply sifting through the data is a very labour intensive, and often means that some of the finer details are missed. The use of alarms and triggers to direct towards periods of abnormal operation is therefore vital. Figure 16 shows the current trace that was recorded on operation of an LV fuse at the Swiss Centre substation (UKPN).

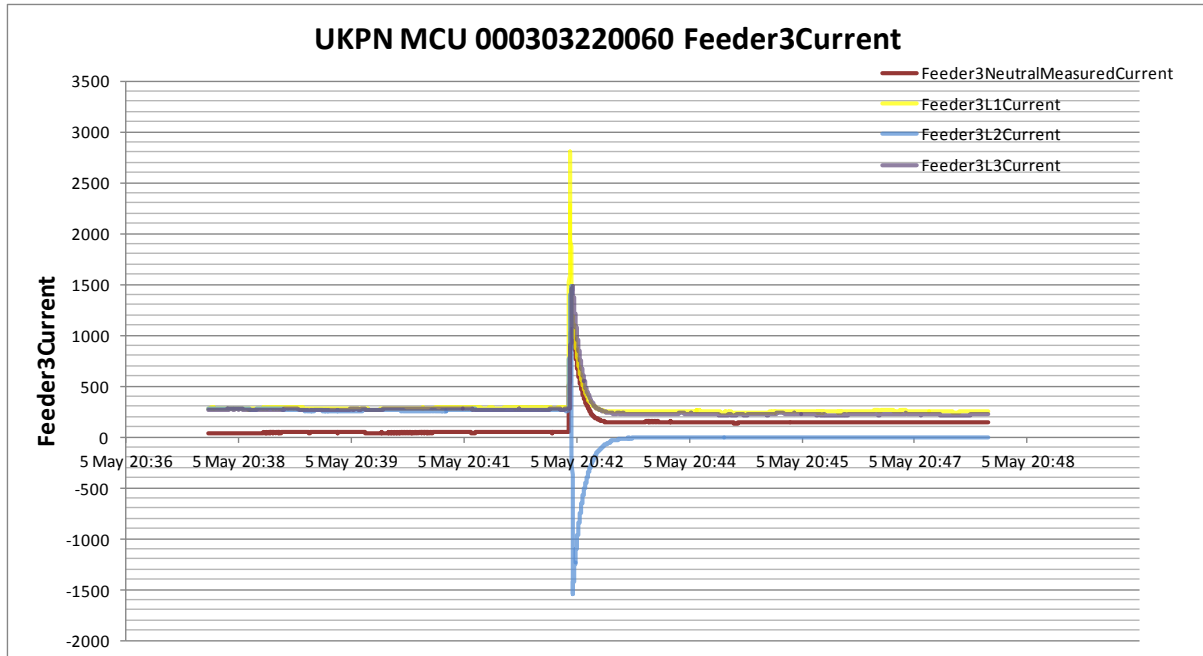

Fig 16 – Trace of current from blown fuse at Swiss Centre (UKPN) –Gridkey

In summary, even the limited amount of data produced by this trial is too much to rely on manual analysis. It is therefore vital that for any wider deployment, suitable analytical tools are utilised to summarise every-day running arrangements into meaningful metrics, and allow the automated identification of abnormal situations.

9. Planned implementation

Substation monitoring will inevitably become a vital part of the electricity network, to help support the understanding of how the LV system is performing. However, at this stage, retrofitting monitoring will be driven by trial projects rather than wide-scale rollout. This is primarily down to the whole life cost of installations and no immediate need for ubiquitous monitoring for safe network operation. The outputs of this project will therefore focus the choice and installation techniques where monitoring is required to support further trial projects. It has also helped to drive further innovation with vendors as they have responded to feedback and develop improved products.

10. Facilitate Replication

Details on the knowledge and products/services required to replicate the outcomes of the project. The DNO should include details of ownership and how to access, the relevant IPR for each item listed.

The main body of text in this report outlines the learnings from this project and will help other businesses develop their own installation processes. Both WPD and UKPN are keen to share the installation procedures and an example is included in Appendix C of this document.

Further information on the current product ranges from manufacturers can be found at the following website addresses.

Locamation	-	www.locamation.nl
Nortech	-	nortechonline.co.uk
GMC i-Prosys	-	www.i-prosys.com
Current	-	www.currentgrid.com
Ambient	-	www.ambientcorp.com
Haysys	-	www.haysys.co.uk
Gridkey (Sentec / Selex)	-	www.gridkey.co.uk
Powersense	-	www.powersense.com

Appendix A – NPL Laboratory Reporting

The following report is a summary of the calibration testing undertaken at the National Physical Laboratory. For the purposes of the reporting all results are presented with each manufacturer identified by a letter as detailed in the table below.

Manufacturer	Sensor In NPL Report
Ambient	Sensor A
Current	Sensor B
Haysys	Sensor C
GMC i-Prosyst	Sensor D
Locamation	Sensor E
PowerSense	Sensor F
Sentec/Selex (Gridkey)	Sensor G



NPL REPORT TQE 8

Western Power Distribution / UK Power Networks
Sensor Comparison Study – Low Carbon Network Fund Tier 1 Project

Adrian J Wheaton

APRIL 2013

Western Power Distribution / UK Power Networks
Sensor Comparison Study – Low Carbon Network Fund Tier 1 Project

Adrian J Wheaton
Time, Quantum and Electromagnetics

ABSTRACT

This report describes tests and presents results on a comparison of seven *Accuracy Class 1* 50 Hz current sensors at the 500 A level for use in Smart Grid trial projects, and to support on-going activities in *Low Carbon Network Fund* projects.

The measurement parameters tested are: accuracy, linearity, positional and rotational sensitivity, end of conductor effects, overload, effect of adjacent conductors, distorted waveforms, amplitude frequency response and temperature performance.

A summary Table is given, performance ranking the sensors for each parameter tested.

© Queen's Printer and Controller of HMSO, 2013

ISSN 1754-2995

National Physical Laboratory
Hampton Road, Teddington, Middlesex, TW11 0LW

Extracts from this report may be reproduced provided the source is acknowledged and the extract is not taken out of context.

Approved on behalf of NPLML by George Pask, Group Leader.

CONTENTS

1 INTRODUCTION
2 TEST INFORMATION
3 SENSOR INFORMATION
4 MEASUREMENTS
4.1 ACCURACY AND LINEARITY MEASUREMENTS
4.2 ROTATIONAL MEASUREMENTS
4.3 POSITIONAL SENSITIVITY MEASUREMENTS
4.4 CONDUCTOR END EFFECTS
4.5 OVER RATED CURRENT TESTS
4.6 PROXIMITY OF ADJACENT CONDUCTORS (STRAY FIELDS)
4.7 DISTORTION WAVEFORM
4.8 TEMPERATURE DEPENDANCE
4.9 AMPLITUDE FREQUENCY RESPONSE
5 COMPARISON OF SENSORS SUMMARY
6 CONCLUSIONS

List of Figures

2.7 <u>Figure 1 - Measurement Setup for Accuracy and Linearity Measurements</u>
2.8 <u>Figure 2 - End Effect Setup</u>
2.9 <u>Figure 3 - Stray Fields Measurement Setup</u>

1 INTRODUCTION

Substation fuseboards or LV boards etc. are normally equipped with one three phase set of current transformers (CTs) on the incoming transformer connection to measure overall substation loading, but the accuracy class of these CTs (normally 5% at rated current but significantly worse at lower levels) is insufficient to meet present needs in conducting “smart grid” trials.

These trials require 1% extended accuracy class measurement of 3 phase LV substation loading which could be achieved by use of Accuracy Class 0.5S CTs. However, it is necessary to shut down the substation to fit these CTs and a “clamp-on” or other non-invasive solution is thus required. Such sensors are specified such that they can fit into available space within fuseboards etc., and where applicable on accessible cable core length.

WPD and UK Power Networks agreed with Ofgem to undertake a small scale, short duration Tier 1 project under Ofgem’s Low Carbon Networks Fund (LCNF) trialling use and evaluating viability of non-invasive current sensor technologies for the measurement of LV currents on up to 15 to 20 distribution substations. As part of this study the accuracy performance of candidate sensors was assessed under laboratory conditions examining a range of measurement parameters that affect the accuracy of the sensors.

This report describes the details of these accuracy tests as performed by the National Physical Laboratory and presents results on a comparison of seven Class 1 50 Hz current sensors submitted by manufacturers to the Tier 1 trial.

2 TEST INFORMATION

Seven sensors were submitted by manufacturers to this comparison trial. These sensors are labelled in this report A through to G. The identity of each sensor is known only to the manufacturer of the sensor and the parties involved in the testing.

Where applicable, the current readings from each unit were taken using customer supplied control software. For each Sensor, results are listed in the following Tables are marked Sensor A, B, C etc. corresponding to each manufacturer's supplied measurement system.

Measurements were performed during May to December 2012.

The mains circuit and voltage inputs of each unit (where appropriate) were energised at 230V, 50 Hz for approximately 24 hours prior to commencement of measurements.

A sub-station cabinet was supplied and modified to allow tests to be performed in a similar environment to a substation. See section 4.1.2 for information. For all tests except *end effects*, *fault current* and *frequency response*, L1 of each of the units was phase locked to the incoming 230 V, 50 Hz voltage signal.

Tests were performed against standard current transformers / current shunts with amplitude accuracies of better than ± 0.01 % of reading.

The reported uncertainties in the Tables are based upon a standard uncertainty multiplied by a coverage factor of $k = 2$, which provides a level of confidence of approximately 95%. The quoted uncertainties apply only to the measured values and do not carry any implication as to the long-term stability of the Measurement System under test. Uncertainty calculations for all tests take into account repeatability and resolution of each sensor tested.

The comparison applies only to the measurements points used. For example a sensor that appears to best perform over the tested temperature range given in this report, will not necessarily best perform over a wider temperature range.

The comparison does not account for the influence of one parameter on another. For example the rotational errors for any given sensor may be different in the presence of stray fields.

The measurements were performed on a single sensor and associated electronics as supplied by the given sensor manufacturer. It should be noted that these "type tests" are not necessarily a representation of all the sensors of that type. Furthermore, errors reported in the following Tables should not be used as correction factors for sensors of any given type. The measurements do not carry any implication as to the long term stability of the sensor / measurement system.

Unless otherwise stated all measurements were performed at an ambient temperature of $20 \pm 1^\circ\text{C}$.

3 SENSOR INFORMATION

Unless otherwise stated only current channel 1 on each sensor system was tested.

Table A below gives the following information on the operation of the seven sensors that were measured:

Resolution – Despite resolution being greater than ± 0.001 A for some sensors, values below this level became insignificant when relative to the calculated overall measurement uncertainties and the results are therefore limited to 0.001 A resolution.

Rated Current – It was assumed that all sensors had a rating of at least 500 A, 50 Hz and could measure a minimum applied current of 5 A, 50 Hz.

Aperture Size – An approximate size of the largest tubular bus bar that could be accommodated.

Flexible or Solid Sensor – Whether the sensor is of either a solid or flexible type.

Ease of connect / reconnect – A rating of 1 (easy) to 5 (difficult) was given to each style of sensor. Easy meaning a relatively short period of time required to connect / reconnect whilst difficult meant that additional tools e.g. a flat bladed screwdriver required to connect / reconnect.

Table A - Characteristics of Sensors					
Sensor ID	Resolution (A)	Rated Current (A)	Approximate Aperture Size (cm)	Flexible or Solid Sensor	Ease of connect / reconnect
A	± 0.001	600	3	Solid	5
B	± 0.001	Not Marked	5	Solid	1
C	± 0.1	Not Marked	14	Flexible	1
D	± 0.01	Not Marked	9	Flexible	1
E	± 0.001	600	3.5	Solid	2
F	± 1	600	5	Solid	5
G	± 0.01	600	2.5	Solid	2

4 MEASUREMENTS

4.1. ACCURACY AND LINEARITY MEASUREMENTS

4.1.1. Purpose of Measurements

The sensors are specified to have an accuracy class of 1 %. This test examines the accuracy at the notational full range current of 500 A. Linearity is often important when using sensors such that they can be used at fractions of their full range current. These tests also examine the performance at a number of lower currents from 1 % of full range (5 A), upwards. The short-term stability of the sensors is also assessed.

4.1.2. Measurement Method

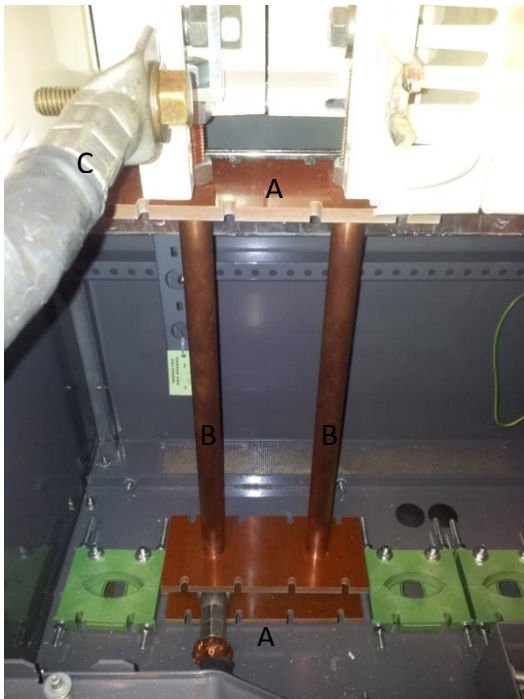

Figure 1 - Measurement Setup for Accuracy and Linearity Measurements

Tests were carried out in a typical sub-station cabinet that was modified to allow the installation of two solid copper bars of 1 inch in diameter connected to the internal bus bar mounts as shown in Figure 1. The distance between the two Tufnel plates at either end was 17 inches long and the centres of the bars being 12 cm apart. This setup allows the sensors to be measured in a similar environment to that of a working substation.

Only the left-hand bar was energised, the right-hand bar providing mechanical support.

Each of the sensors were individually (one at a time) placed on the left hand bar, positioned midway up the vertical conductor.

The labels in Figure 1 indicate the following:

- (A) – Tufnel Plates
- (B) – Solid Copper Bars
- (C) – Supply Input Cable

Each sensor was positioned on the conductor and rotated horizontally in approximately 90° steps, the current reading being recorded at each position with the conductor being centralised in the aperture. From these four positions, an “average” current reading was calculated. The sensor was then positioned on the conductor such that this “average” output reading was observed. The sensor was then not moved for the duration of the *accuracy and linearity* measurements.

For these tests, a dual channel waveform synthesizer was used to provide AC sinusoidal waveforms for current and voltage channels with a fixed and adjustable phase relationship. One synthesizer channel was used to supply a power amplifier / 1 kA supply transformer combination to provide current levels up to 500 A. The other synthesizer channel was used to supply a voltage amplifier to provide a voltage level of 230 V to the voltage channel of each system.

The test was performed on each sensor at 1%, 5%, 10%, 20%, 30%, 50%, 75% and 100% of 500 A.

Each sensor was measured over several days and the results presented in the following Tables are an average of these results. The standard deviations of these averages are an indication of the short-term variation/stability of the sensors. The uncertainties given in Table 1 include this standard deviation component, or so-called Type-A uncertainty.

4.1.3. Measurement Results

Table 1 - Accuracy and Linearity Tests							
Nominal Applied Current	Current Reading						
	Sensor A	Sensor B	Sensor C	Sensor D	Sensor E	Sensor F	Sensor G
(A)	(A)	(A)	(A)	(A)	(A)	(A)	(A)
5		5.113		4.89	4.999	4	4.91
25	24.531	24.984	24.7	24.63	24.970	24	24.88
50	49.469	49.953	49.1	49.05	49.939	49	49.76
100	99.594	99.889	97.8	98.05	99.796	99	99.52
150	149.791	149.821	146.8	147.03	149.687	149	149.29
250	250.483	249.712	244.8	244.72	249.489	249	248.93
375	377.352	374.675	367.0	366.87	374.213	373	373.47
500	504.436	499.756	489.6	488.24	498.893	498	498.67
Nominal Applied Current	Uncertainty in Current Reading						
	Sensor A	Sensor B	Sensor C	Sensor D	Sensor E	Sensor F	Sensor G
(A)	(A)	(A)	(A)	(A)	(A)	(A)	(A)
5		± 0.052		± 0.03	± 0.006	± 2	± 0.08
25	± 0.021	± 0.015	± 0.2	± 0.03	± 0.009	± 2	± 0.01
50	± 0.043	± 0.029	± 0.2	± 0.06	± 0.018	± 2	± 0.03
100	± 0.086	± 0.059	± 0.2	± 0.11	± 0.036	± 2	± 0.05
150	± 0.129	± 0.088	± 0.2	± 0.17	± 0.055	± 2	± 0.08
250	± 0.214	± 0.147	± 0.3	± 0.28	± 0.091	± 2	± 0.13
375	± 0.322	± 0.220	± 0.3	± 0.41	± 0.137	± 2	± 0.19
500	± 0.429	± 0.294	± 0.5	± 0.55	± 0.182	± 2	± 0.25

A black cell indicates no measurement performed at that current level. Due to the limited aperture size, the measurements on Sensor G were not performed on the vertical conductor but on the supply input cable.

The results in Table 1 above indicate the performance of each sensor across the working current range. These results are given in amps. It can be seen that the sensors do not read exactly the nominal applied current. The difference between the actual reading and nominal applied is defined as the “Accuracy Error”. In an ideal situation this would be zero. Accuracy errors as a percentage of nominal applied current are given in Table 1a.

For further information on sensor performance, the data has been analysed and plotted on graphs together with a linear fit. Table 1b displays the departure from the linear fit both in percentage and in amps. The linear fit was obtained using the “Data Analysis Regression” facility in Microsoft EXCEL.

Table 1a - Error, % of Nominal Applied Current							
Nominal Applied Current	Current Reading						
	Sensor A	Sensor B	Sensor C	Sensor D	Sensor E	Sensor F	Sensor G
(A)	(%)	(%)	(%)	(%)	(%)	(%)	(%)
5		2.251		-2.26	-0.020	-19	-1.89
25	-1.877	-0.062	-1.2	-1.47	-0.118	-4	-0.50
50	-1.063	-0.094	-1.9	-1.90	-0.122	-2	-0.47
100	-0.406	-0.111	-2.2	-1.95	-0.204	-1	-0.48
150	-0.139	-0.120	-2.1	-1.98	-0.209	-1	-0.47
250	0.193	-0.115	-2.1	-2.11	-0.204	-1	-0.43
375	0.627	-0.087	-2.1	-2.17	-0.210	0	-0.41
500	0.887	-0.049	-2.1	-2.35	-0.221	0	-0.27
Nominal Applied Current	Uncertainty in Current Reading						
	Sensor A	Sensor B	Sensor C	Sensor D	Sensor E	Sensor F	Sensor G
(A)	(%)	(%)	(%)	(%)	(%)	(%)	(%)
5		± 1.042		± 0.41	± 0.118	± 23.2	± 1.70
25	± 0.086	± 0.059	± 0.5	± 0.11	± 0.036	± 4.7	± 0.05
50	± 0.086	± 0.059	± 0.3	± 0.11	± 0.036	± 2.4	± 0.05
100	± 0.086	± 0.059	± 0.2	± 0.11	± 0.036	± 1.2	± 0.05
150	± 0.086	± 0.059	± 0.1	± 0.11	± 0.036	± 0.8	± 0.05
250	± 0.086	± 0.059	± 0.1	± 0.11	± 0.036	± 0.5	± 0.05
375	± 0.086	± 0.059	± 0.1	± 0.11	± 0.036	± 0.4	± 0.05
500	± 0.086	± 0.059	± 0.1	± 0.11	± 0.036	± 0.3	± 0.05

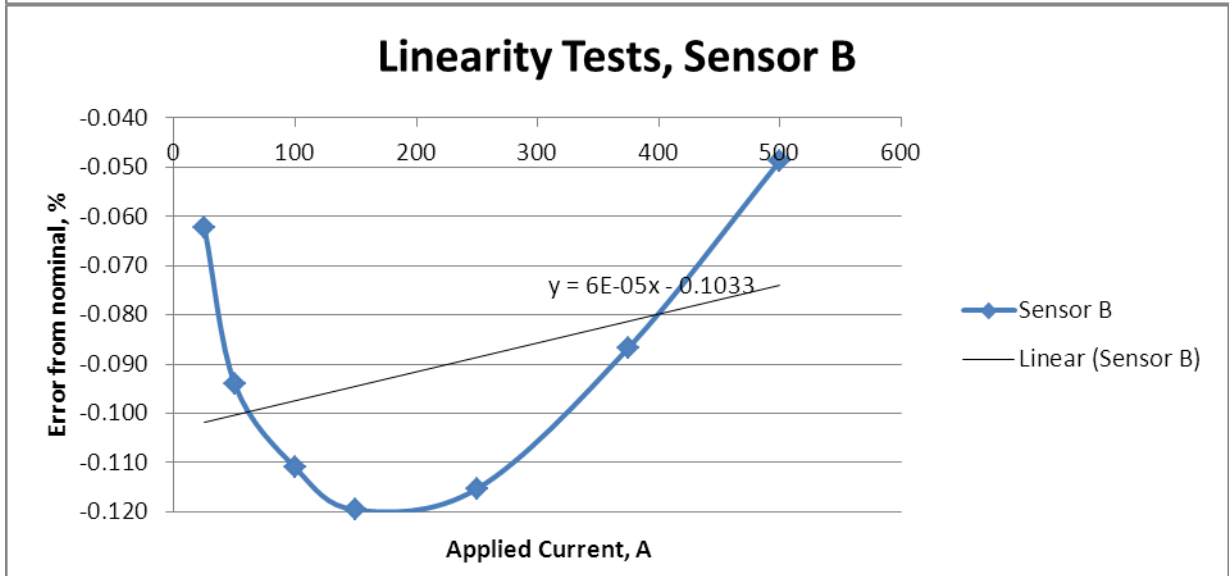
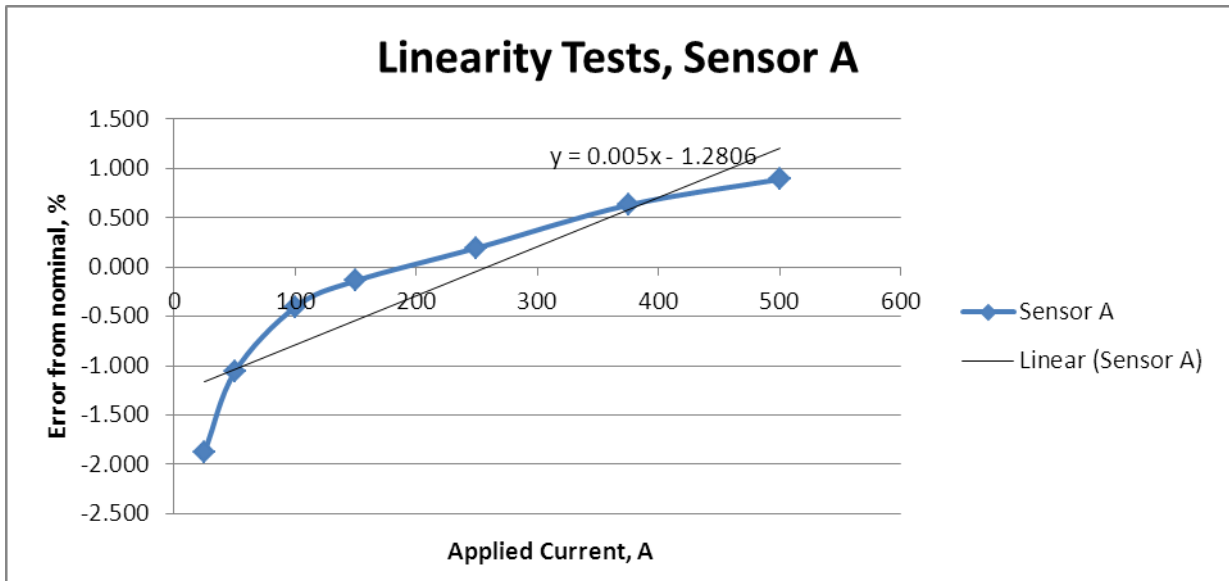

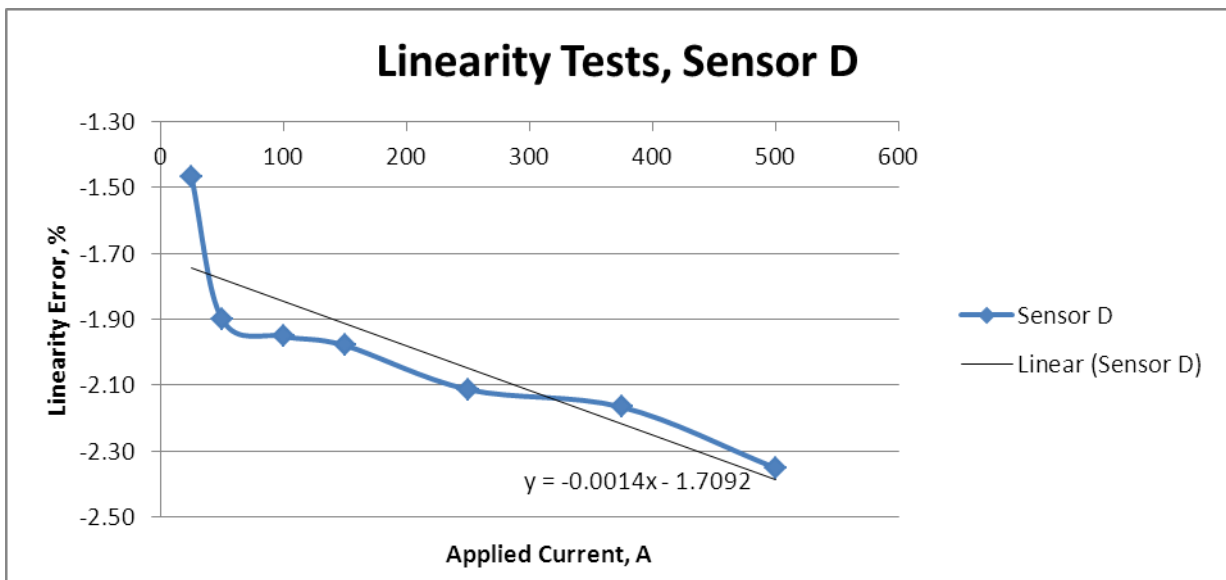
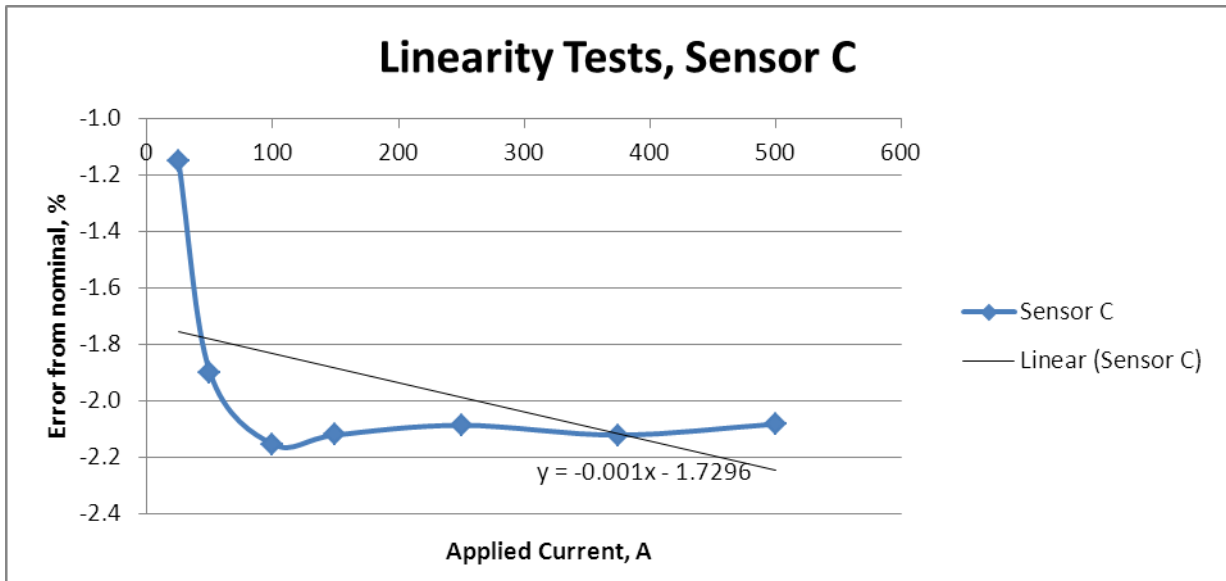

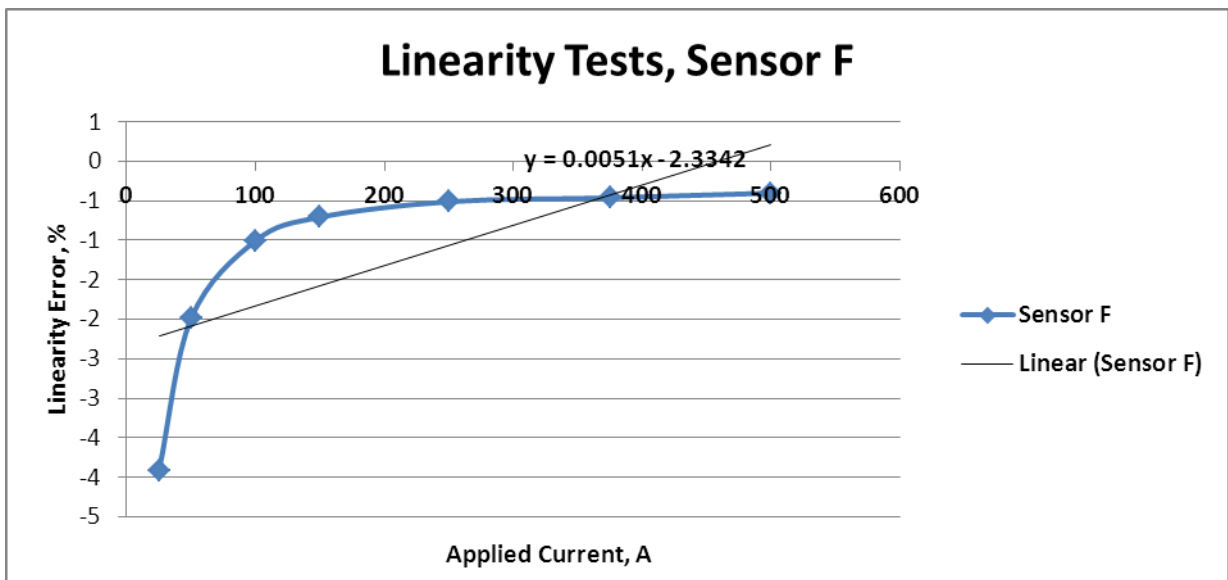
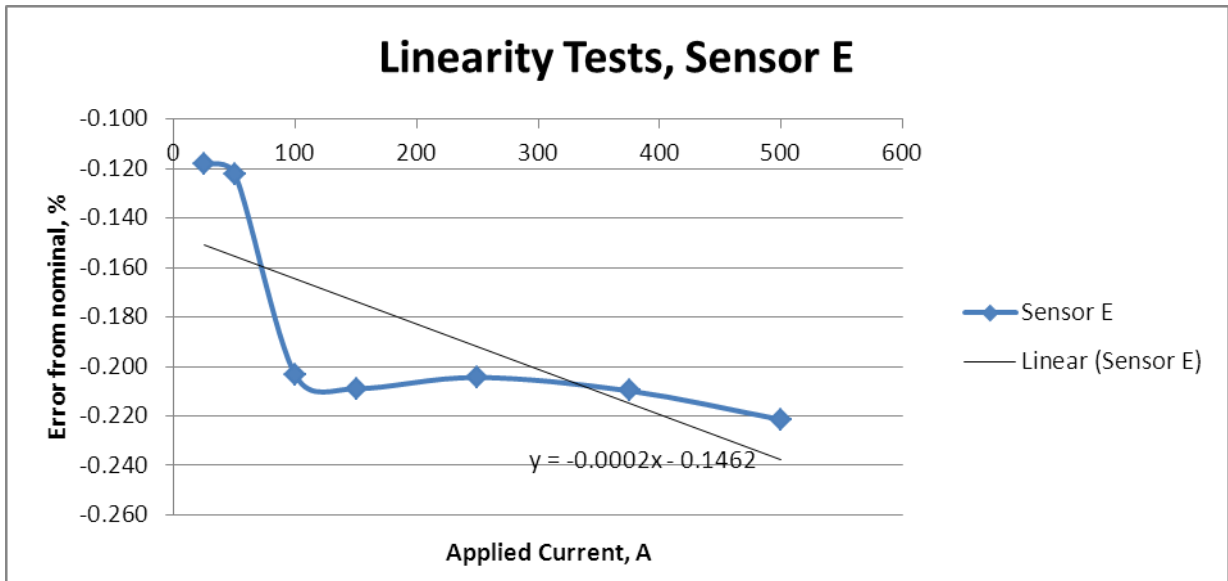

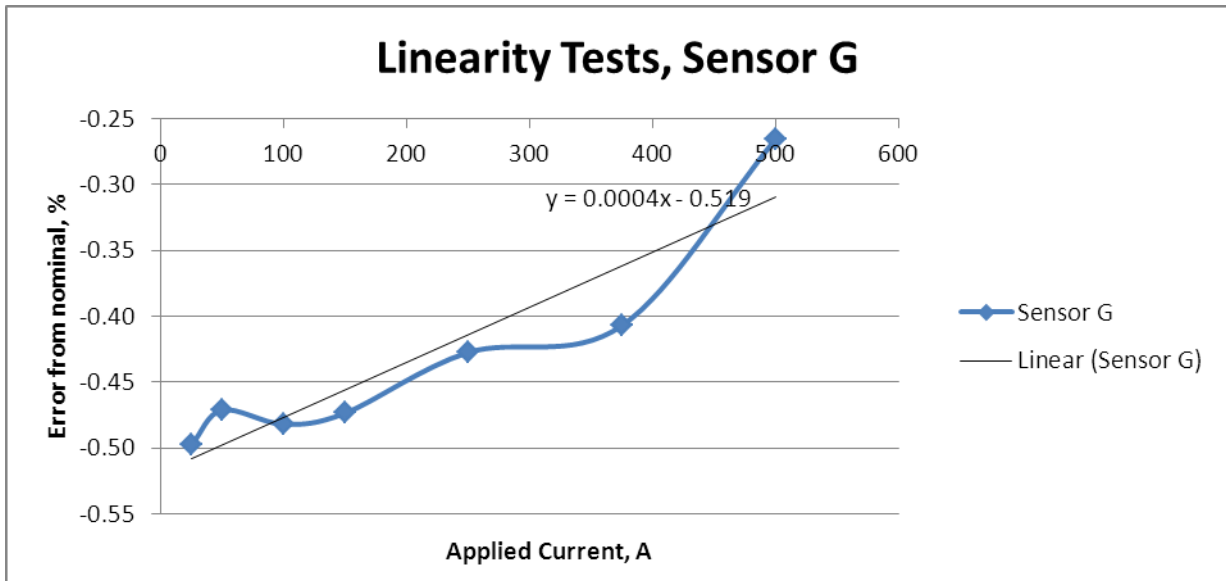

The results in Table 1b below indicate the departure from the linear fit for each sensor both in percentage of nominal applied current and in amps.

Nominal Applied Current (A)	Current Reading													
	Sensor A		Sensor B		Sensor C		Sensor D		Sensor E		Sensor F		Sensor G	
	(%)	(A)	(%)	(A)	(%)	(A)	(%)	(A)	(%)	(A)	(%)	(A)	(%)	(A)
25	-0.720	-0.177	0.040	0.010	0.6	0.1	0.28	0.07	0.033	0.008	-2	0	0.01	0.00
50	-0.030	-0.015	0.006	0.003	-0.1	-0.1	-0.12	-0.06	0.033	0.017	0	0	0.03	0.01
100	0.378	0.377	-0.014	-0.014	-0.3	-0.3	-0.11	-0.10	-0.039	-0.039	1	1	0.00	0.00
150	0.398	0.596	-0.025	-0.038	-0.2	-0.3	-0.07	-0.10	-0.035	-0.053	1	1	-0.02	-0.03
250	0.235	0.588	-0.027	-0.067	-0.1	-0.2	-0.07	-0.16	-0.013	-0.031	1	1	-0.01	-0.03
375	0.049	0.186	-0.005	-0.020	0.0	0.0	0.05	0.19	0.005	0.018	0	0	-0.05	-0.17
500	-0.310	-1.565	0.025	0.126	0.2	0.8	0.03	0.17	0.016	0.080	-1	-3	0.04	0.22

4.1.4. Commentary on Results

Table 1a shows that Sensors B, E and G maintained an accuracy of better than 1 % of reading down to 5 % of full scale. Sensor E gave the best performance with accuracy of around 0.2 % down to 1 % of range.

In the case of linearity measurements from 5 % of full range, all sensors except for Sensor F were within 1 % of reading. Sensors G and B have linearity errors less than the ability to measure, as indicated by the uncertainties in Table 1. Only Sensor E maintains its linearity at less than 1 % error to at least 1% of full current.

4.2. ROTATIONAL MEASUREMENTS

Non-invasive sensors work by coupling of the electric and/or magnetic field associated with the current being measured. The strength of this coupling and therefore the reading of the sensor will depend on the position of the sensor with respect to the current carrying conductor.

To facilitate sensor installation without interrupting the power in the substations, sensors are manufactured with a split to enable them to be opened up to be put around a conductor then closed for use. On a sensor that can be split or opened the region of the join or split is often particularly sensitive to relative position.

Other factors such as sensor aperture size and the position of the exit of the output cable from the sensor can affect the results of non-invasive sensors.

These tests assess the sensitivity of the sensor to rotation in the horizontal plane; measurements were made on each sensor in different positions around the busbar.

4.2.1. Measurement Method

These tests were performed in the substation cabinet as described in Section 4.1.2, *Accuracy and Linearity* measurements.

Rotational Measurements were performed at 250 A and each sensor in turn was placed on the left hand vertical copper bus bar (see Figure 1) and rotated horizontally in approximately 90° steps, the current reading being recorded at each position with the conductor being centralised in the aperture.

The same supply settings were used as for the *accuracy and linearity* measurements.

4.2.2. Measurement Results

The results in Table 2 below indicate the maximum spread in current reading when rotating the sensor in the horizontal plane in 90° steps.

Table 2 - Rotational Measurements Around Vertical Bus Bar				
Nominal Applied Current (A)	Sensor ID	Current Reading		Uncertainty in Average Current Reading (A)
		Maximum Spread	Average	
		(A)		
250	A	0.102	250.807	± 0.078
	B	0.075	249.989	± 0.195
	C	0.9	244.4	± 0.2
	D	4.76	248.52	± 0.25
	E	0.181	249.637	± 0.039
	F	1	248	± 2
	G	0.49	249.38	± 0.13

The maximum spread in Table 2 is the difference between the lowest and highest readings taken from the sensor whilst being rotated around the bus bar.

4.2.3. Commentary on Results

All sensors with exception of Sensor D showed rotational sensitivity less than 1% of reading. Sensors A,C,D,E and G showed what could be described as “sensitivity to rotation” giving maximum spreads greater than a multiple of their measurement uncertainties. By contrast, Sensors B showed no significant rotational effect. Any rotational effects on the results of Sensor F were masked by its low resolution.

4.3. POSITIONAL SENSITIVITY MEASUREMENTS

4.3.1. Purpose of Measurements

These tests will determine the sensitivity of the sensor of having the current carrying conductor off-centre in the sensor aperture. This situation will often occur in practice as a sensor will often be fitted such that gravity pulls it to a resting place on one side of a vertical conductor.

4.3.2. Measurement Method

Rotational measurements described in Section 4.2 were made with the current carrying conductor centralised in the sensor aperture. Depending on the shape of the sensor and clearance from the busbar, in these tests, the current carrying conductor was positioned off-centre, firstly next to the sensor split and then opposite the sensor split.

Positional Sensitivity Tests were performed at 250 A and each sensor in-turn was placed on the left hand vertical copper bus bar (see Figure 1) and then where possible the sensor was moved laterally in the horizontal plane such that the copper bus bar was next to the split and then furthest from the split.

The same supply settings were used as for the *accuracy and linearity* measurements.

4.3.3. Measurement Results

The results in Table 3 below indicate the maximum difference between the current readings with the copper bus bar being next to the sensor “split” and then furthest from the sensor “split”.

Nominal Applied Current (A)	Sensor ID	Current Reading		Uncertainty in Average Current Reading (A)
		Maximum Difference (A)	Average	
250	A			
	B	0.338	249.714	± 0.195
	C	2.9	244.9	± 0.2
	D	0.96	242.24	± 0.25
	E	0.039	249.475	± 0.039
	F	1	249	± 2
	G			

A black cell indicates no measurement performed due to the aperture size of the transducer, as the bus bar filled the aperture this test was not possible as there was no horizontal movement.

4.3.4. Commentary on Results

All sensors with exception of Sensor C showed positional sensitivity less than 1 % of reading. Sensors C, D and B showed what could be described as “sensitivity to position” giving maximum spreads greater than a multiple of their measurement uncertainties. By contrast, Sensors E showed no significant rotational effect. Any rotational effects on the results of Sensor F were masked by its low resolution.

The observed differences seem to be related to aperture size, the smallest having the lowest positional error. For example, the largest difference in current reading was observed from Sensor C which had the biggest overall aperture.

4.4. CONDUCTOR END EFFECTS.

4.4.1. Purpose of Measurements

Non-invasive sensors can be sensitive to end-of-conductor effects which occur because of the distorted field around this part of the conductor as it changes direction. For example a sensor near a right angle bend in a conductor will couple field on two axes, on the aperture plain and adjacent to it. These tests will assess the sensitivity of these sensors to these end-effect errors.

4.4.2. Measurement Method

In order to assess the 'end effect' the sensor was moved to each end of the conductor to the point where the conductor bends away marked P1 and P2 in Figure 2 below.

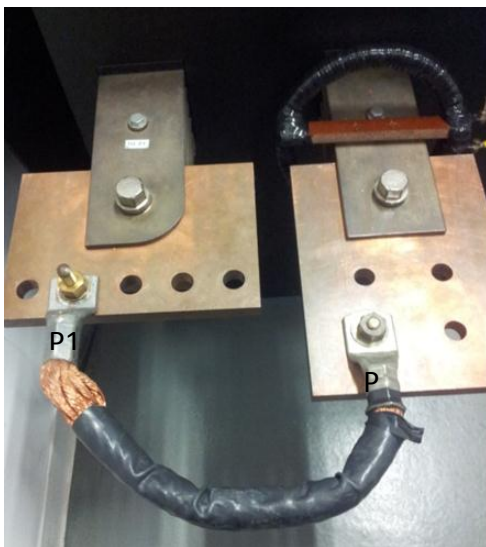

Figure 2 - End Effect Setup

A cable was positioned between the output plates of the high current source as shown in Figure 2.

Measurements were performed at both ends of the cable (P1 – left hand side and P2 – right hand side) and in the middle at 500 A.

Performing the measurements in the substation cabinet setup used in previous tests would have been preferred, but it was not possible to securely mount each of the sensors at the various positions keeping the sensors horizontal. Furthermore the aperture of sensor G was not large enough to accept the vertical conductor as used in the cabinet.

Measurements of conductor end effects were performed using a standard current comparator driven from the mains supply. The phase relationship between the voltage and current was approximately 40°.

4.4.3. Measurement Results

The results in Table 4 indicate the recorded current levels when each sensor was positioned along the cable. The maximum spread in Table 4 shows the variation in current readings at the three positions.

Nominal Applied Current (A)	Sensor ID	Current Reading (A)				Uncertainty in Current Reading (A)
		P1	Middle	P2	Maximum Spread	
500	A	503.686	503.667	502.663	1.023	± 0.165
	B	499.053	499.946	499.376	0.893	± 0.869
	C	491.1	490.4	492.2	1.9	± 0.3
	D	497.64	497.67	496.44	1.23	± 0.19
	E	498.691	498.685	499.025	0.340	± 0.181
	F	497	497	497	0	± 2
	G	498.91	499.74	498.30	1.44	± 0.74

4.4.4. Commentary on Results

All sensors with exception of the resolution limited Sensor F showed some spread, although the relatively low spread in Sensor B results is comparable with the measurement uncertainty and therefore can be deemed to have no significant end-effect. Other sensors show spreads of various multiples of the measurement uncertainty however all are less than 1 % of reading.

4.5. OVER RATED CURRENT TESTS

4.5.1. Purpose of Measurements

The sensor could be subjected to a short duration overload current when installed in a substation. The purpose of this test is to confirm that the sensor system still operates after being subjected to a higher current level and to assess the performance when it is returned to normal full scale current.

4.5.2. Measurement Method

Measurements of overload current were performed using the same setup as described in Section 4.4.2. A current of 500 A was applied both before and after each sensor was subjected to the “overload current” to confirm that the sensor system still operated as expected.

The overload current level was 2kA for all sensors except for Sensor G where a 1 kA maximum current was applied due to limited aperture size for conductor.

Measurements of overload current were performed using a standard current comparator driven from the mains supply. The phase relationship between the voltage and current was approximately 40°.

4.5.3. Measurement Results

The results in Table 5 below indicate that all sensors continued to record current when subjected to an overload current. In Table 5, ‘Pre’ indicates that 500 A was applied before the overload current and ‘Post’ indicates that 500 A was applied after the overload current was applied.

Table 5 - Over Rated Current Tests				
Sensor ID	Current Reading			Uncertainty in Current Reading
	500A Pre	2 kA	500A Post	
	(A)			(A)
A	503.474	1143.467	504.685	± 0.206
B	499.800	979.512	500.248	± 0.631
C	488.8	1944.8	488.6	± 0.6
D	504.55	782.91	504.78	± 0.53
E	498.231	1696.900	497.594	± 0.071
F	496	951	497	± 2
G	500.19	1000.00	500.18	± 0.46

4.5.4. Commentary on Results

With exception of Sensor C, it was noted that the systems saturated and recorded values very different to the applied current. It was not clear whether this was due to the sensor or the measurement system or a combination of both.

With the exception of Sensor A and E, it was noted that the difference between the ‘Pre’ and ‘Post’ readings was within the given uncertainty indicating that the overload current did not cause any damage to the sensor or any change in the sensor gain. The changes to the readings of Sensors A and E were greater than 0.1 %, it is not clear whether this is a short-term gain change, or whether a given sensor gain will eventually recover to its previous value.

4.6. PROXIMITY OF ADJACENT CONDUCTORS (STRAY FIELDS)

4.6.1. Purpose of Measurements

Sensors will couple electric and magnetic fields from adjacent conductors causing errors in their reading. In a typical substation installation, the sensors will be placed on conductors adjacent to other conductors on different phases. These tests determine the sensitivity of the sensors to a near-by conductor energized at various phase differences to the current being measured by the sensor.

In order to determine the sensitivity of each sensor to an adjacent conductor on a different phase, the change in reading was observed with and without an energised parallel conductor at various phase angles with respect to the sensor current being measured.

4.6.2. Measurement Method

Each sensor was tested at a current level of 20 A in the presence of a parallel conductor carrying 20 A, 50 Hz at various phase displacements.

Measurements were performed at 20 A, 50 Hz with horizontal conductors 12 cm apart (the separation as for tests in the sub-station cabinet) as shown in Figure 3.

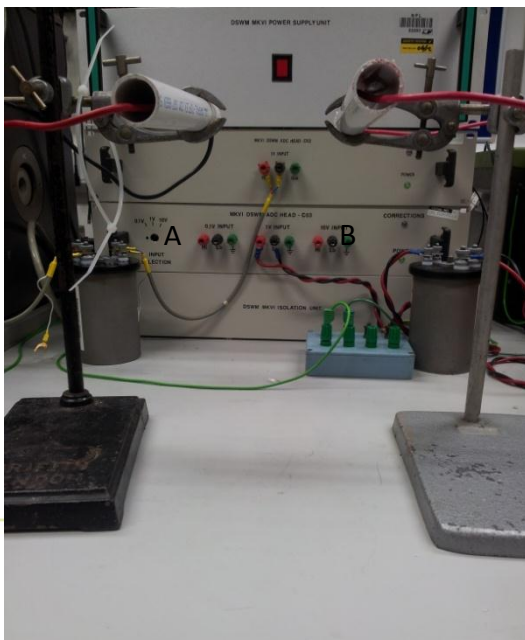

Figure 3 - Stray Fields Measurement Setup

A current of 20 A, 50 Hz was applied to channels 1 and 2 of each sensor measurement system in turn. The channel 1 sensor was placed on the left hand horizontal bus bar marked A in Figure 3 and the channel 2 sensor was placed on the right hand horizontal bus bar marked B in Figure 3.

For these measurements, the NPL digital sampling wattmeter (DSWM) was used. This system allows the phase between the two channels to be varied with an accuracy of $\pm 0.002^\circ$ across the full 360° range. Two standard current transformers were used, one for each channel, both having amplitude and phase accuracies of better than 0.01 %, 0.001° respectively. As was the case for the accuracy and linearity measurements (see section 4.1.2), the 230 V mains supply voltage and channel 1 current channel were phase locked together.

Prior to energising the second right hand bus bar, a base line measurement was performed at 20 A on the first bus bar. For these tests there was no current passing through the right hand bus bar. The results for these tests are in Table 6a.

The current was then applied to the second right hand busbar and the phase was set to various angles and current readings on Channel 1 were recorded at each setting.

The uncertainty in the applied phase as indicated in Table 6 was $\pm 0.03^\circ$.

4.6.3. Measurement Results

Table 6 - Phase Tests L1 & L2, 20A 50 Hz Applied							
Ch 2 Applied Phase (°)	Current Reading						
	Sensor A	Sensor B	Sensor C	Sensor D	Sensor E	Sensor F	Sensor G
	Ch1 (A)	Ch1 (A)	Ch1 (A)	Ch1 (A)	Ch1 (A)	Ch1 (A)	Ch1 (A)
0.00	19.599	20.000	20.4	20.28	20.003	19	19.99
90.00	19.558	20.002	20.7	20.25	19.997	19	19.99
120.00	19.550	20.009	20.7	20.23	19.999	19	19.99
180.00	19.533	19.991	20.5	20.22	20.003	19	19.99
240.00	19.552	20.015	20.3	20.23	20.010	19	19.99
270.00	19.556	20.007	20.2	20.24	20.006	19	19.99
Ch 2 Applied Phase	Difference Between Each Angle Measurement and Baseline Current Measurement (Table 6a)						
	Sensor A	Sensor B	Sensor C	Sensor D	Sensor E	Sensor F	Sensor G
0	Ch1 (A)	Ch1 (A)	Ch1 (A)	Ch1 (A)	Ch1 (A)	Ch1 (A)	Ch1 (A)
0.00	0.033	-0.001	0.2	0.04	0.003	0	0.00
90.00	-0.007	0.000	0.5	0.01	-0.003	0	0.00
120.00	-0.015	0.007	0.5	0.00	-0.001	0	0.00
180.00	-0.032	-0.011	0.3	-0.02	0.003	0	0.00
240.00	-0.013	0.014	0.1	-0.01	0.010	0	0.00
270.00	-0.009	0.006	0.0	0.01	0.006	0	0.00
Applied Phase (°)	Uncertainty in Current Reading						
	Sensor A	Sensor B	Sensor C	Sensor D	Sensor E	Sensor F	Sensor G
	(A)	(A)	(A)	(A)	(A)	(A)	(A)
0.00	± 0.024	± 0.036	± 0.3	± 0.02	± 0.028	± 2	± 0.01
90.00	± 0.024	± 0.036	± 0.3	± 0.02	± 0.028	± 2	± 0.01
120.00	± 0.024	± 0.036	± 0.3	± 0.02	± 0.028	± 2	± 0.01
180.00	± 0.024	± 0.036	± 0.3	± 0.02	± 0.028	± 2	± 0.01
240.00	± 0.024	± 0.036	± 0.3	± 0.02	± 0.028	± 2	± 0.01
270.00	± 0.024	± 0.036	± 0.3	± 0.02	± 0.028	± 2	± 0.01

Table 6a - Results for Channel 1 only, 20A 50 Hz Applied		
Sensor ID	Channel 1 Current Reading (A)	Uncertainty in Current Reading (A)
A	19.565	± 0.024
B	20.002	± 0.036
C	20.2	± 0.3
D	20.24	± 0.02
E	20.000	± 0.028
F	19	± 2
G	19.99	± 0.01

4.6.4. Commentary on Results

The difference between each angle sensor measurement and the baseline current measurement in Table 6 gives an indication of the sensitivity of each sensor to adjacent conductors. Sensors B, E, F and G have differences of less than the measurement uncertainty for all angles tested and it can be concluded that no significant effect could be detected. Sensors A, C and D all show some changes greater than the measurement uncertainty indicating that there is some effect. Only Sensor C shows a change greater than 1 %.

4.7. DISTORTION WAVEFORM

4.7.1. Purpose of Measurements

In general the current waveform measured by these sensors will be distorted due to the nature of the non-linear loads on a typical sub-station feeder. Such waveforms are composed of a fundamental 50 Hz component and a series of harmonics. The sensor should be able to measure the root-mean-square (RMS) value of the current with the target accuracy, regardless of whether it is a single sinewave fundamental or whether it contains high frequency harmonic components. The purpose of these measurements is to examine the effect a distorted waveform on the current RMS readings of each sensor.

4.7.2. Measurement Method

The sensors were placed in-turn on a horizontal bus bar. Each of the measurement systems were subjected to waveforms, both nominally 17 A rms, 50 Hz the details of which are as follows:

- (1) Waveform 1 consisted only of the fundamental (50 Hz)
- (2) Waveform 2 was a complex waveform consisting of the fundamental (50 Hz) and two harmonics (3rd, 150 Hz and 5th, 250 Hz) both at a nominal amplitude level of 10 % of the fundamental. The phase of each of the two harmonics was nominally zero with respect to the fundamental.

The RMS value of the applied waveforms was measured using standard digital sampling equipment.

These measurements were performed at 17 A RMS rather than the full scale 500 A, due to the lack of standard current measurement capability above 20 A peak to peak, at frequencies higher than 50 Hz.

As was the case for the accuracy and linearity measurements (see section 4.1.2), the 230 V mains supply voltage and channel 1 current channel were phase locked together.

4.7.3. Measurement Results

Table 7 - Results for channel 1, 17A rms Applied				
Sensor ID	Waveform 1	Waveform 2	Difference	Uncertainty in Current Reading
	Ch1 (A)	Ch1 (A)	(A)	(A)
A	16.551	16.524	-0.027	± 0.012
B	17.022	17.031	0.009	± 0.032
C				
D	16.96	16.94	-0.02	± 0.02
E	16.984	16.948	-0.036	± 0.005
F	16	17	1	± 2
G	16.96	16.92	-0.04	± 0.02

Sensor C lowest recordable reading was 20 A hence no measurements were performed in Table 7.

4.7.4. Commentary on Results

Ideally each sensor should read (within the uncertainty) the same current for Waveforms 1 and 2.

In all cases the difference between the two RMS values was less than 1 % of reading. The recorded difference for Sensors B, D and F were less than the uncertainty. Sensor E showed the biggest difference of 0.2 % of reading.

4.8. TEMPERATURE DEPENDANCE

4.8.1. Purpose of Measurements

When the sensor measurement systems are installed in a substation, they will be subjected to the fluctuating temperatures. The aim of these measurements is to determine whether the measurement systems perform over an extended temperature range and report the change in readings.

4.8.2. Measurement Method

The measurement systems were placed into a temperature controlled cabinet and subjected to temperatures of approximately 2.5°C, 21°C and 39°C. For each temperature point the units were left in the temperature cabinet for a minimum of 24 hours prior to the measurements being performed. The sensors were briefly removed from the temperature cabinet to be measured.

Each unit was powered up using the same AC voltage source as described in Section 4.1.2. A current of 20 A was applied to a horizontal bus bar (as seen in Figure 3) and in turn each sensor was placed on this bus bar. The phase between the supply AC voltage and current signals was adjusted to read nominally 0°.

These measurements were performed at 20 A rather than the full scale 500 A due to the location of the temperature cabinet and also to reduce any localized heating that could affect the results.

The uncertainty in the indicated chamber temperature as indicated in Table 8 was $\pm 1^\circ\text{C}$.

4.8.3. Measurement Results

The results in Table 8 below indicate that all the measurement systems operated at the extended temperatures although they were only subjected to each temperature level for no more than 48 hours. Table 8 also gives an indication of the temperature sensitivity of the sensors.

Table 8 - Temperature Tests (Nominal 20A, 50 Hz Applied to L1 only)							
Indicated Chamber Temperature (°C)	Current Reading						
	Sensor A (A)	Sensor B (A)	Sensor C (A)	Sensor D (A)	Sensor E (A)	Sensor F (A)	Sensor G (A)
39	19.494	20.019	19.7	19.68	20.094	19	19.86
21	19.553	20.013	19.8	19.79	19.830	19	19.98
2.5	19.586	20.019	19.8	19.89	19.737	19	19.99
Indicated Chamber Temperature (°C)	Uncertainty in Current Reading						
	Sensor A (A)	Sensor B (A)	Sensor C (A)	Sensor D (A)	Sensor E (A)	Sensor F (A)	Sensor G (A)
39							
21	± 0.032	± 0.023	± 0.2	± 0.02	± 0.014	± 2	± 0.02
2.5							

4.8.4. Commentary on Results

Sensors A, D, E and G all show some sensitivity to temperatures. Sensor A and G both give less than 1% change with temperature over this range, whereas both Sensors D and E show changes of 1.1% and 1.8% respectively over this temperature range.

Sensors C and F show no change within their limited resolution. Sensor B has the least sensitivity to temperature, any changes in the results being less than the measurement uncertainty.

4.9. AMPLITUDE FREQUENCY RESPONSE

4.9.1. Purpose of Measurements

As described in Section 4.7 the sensor measurement system could be subjected to distorted waveforms containing harmonic components at higher frequencies. These tests will assess the amplitude reading change of each of the measurement systems at differing frequencies up to 2 kHz. The upper frequency of 2 kHz was chosen to correspond to the 40th harmonic which is often specified in international standards on power quality.

4.9.2. Measurement Method

For the frequency response tests the supply voltage channels of all the measurement systems were connected to the laboratory mains supply. A current amplifier was used to supply a current of 20 A at frequencies ranging from 50 Hz to 2 kHz. This current was applied to each measurement system in turn through a horizontal bus bar (as seen in Figure 3). A calibrated current shunt with an accuracy of better than ± 0.01 % was used to monitor the current levels at the applied frequencies.

Only amplitude readings were recorded for the sensors.

These measurements were performed at 20 A rather than the full scale 500 A, due to the lack of standard current measurement capability above 20 A, at frequencies higher than 50 Hz.

4.9.3. Measurement Results

Table 9 - Frequency Tests (Nominal 20A Applied to L1 only)							
Nominal Applied Frequency (Hz)	Current Reading						
	Sensor A (A)	Sensor B (A)	Sensor C (A)	Sensor D (A)	Sensor E (A)	Sensor F (A)	Sensor G (A)
50	19.459	20.012	20.1	20.07	19.913	19	19.94
100	19.323	20.004	19.9	19.42	19.882	19	19.89
400	19.094	19.806	20.7	19.29	19.529	34	19.66
1 000	18.105	18.730	24.3	19.29	17.911	1	18.36
2 000	15.402	13.188	34.3	19.29	N/A	N/A	12.38
Nominal Applied Frequency (Hz)	Uncertainty in Current Reading						
	Sensor A (A)	Sensor B (A)	Sensor C (A)	Sensor D (A)	Sensor E (A)	Sensor F (A)	Sensor G (A)
50							
100							
400	± 0.011	± 0.013	± 0.2	± 0.05	± 0.006	± 2	± 0.11
1 000							
2 000							

Table 9a - Frequency Tests Sensor Reading Change from 50 Hz							
Nominal Applied Frequency (Hz)	Current Reading Change						
	Sensor A (%)	Sensor B (%)	Sensor C (%)	Sensor D (%)	Sensor E (%)	Sensor F (%)	Sensor G (%)
100	-0.68	-0.04	-1	-3.3	-0.16	0	-0.2
400	-1.82	-1.03	3	-3.9	-1.92	75	-1.4
1 000	-6.77	-6.41	21	-3.9	-10.01	-90	-7.9
2 000	-20.28	-34.12	71	-3.9	N/A	N/A	-37.8

N/A in the Tables 9 and 9a indicate that no reading by the sensor was recorded at that measurement point.

4.9.4. Commentary on Results

All sensors show sensitivity to frequency and all are at or greater than 1 % in error at 400 Hz. For some sensors, errors above 400Hz are large; caution should be exercised if these sensors are to be used for current harmonics measurements up to the 40th harmonic as defined by international standards.

5 COMPARISON OF SENSORS SUMMARY

To provide an overview of each of the sensors performances across the range of tests, Table 10 below displays a ranking for each test performed. A ranking of 1 indicates the sensor performed the best increasing through to 7 for the worst. The ranking takes into account sensor resolution and overall uncertainty. N/A in Table 10 indicates that no measurement was performed at that point.

Highlighted cells in Table 10 indicate that a sensor error at the given measurement parameter exceeded 1 % error. This threshold was applied to all measurement parameters except frequency response. A threshold of 1 % has been used as the sensors have an Accuracy Class 1; however, it should be noted that it is not usual to test such a wide range of parameters when verifying Class 1 CTs.

	Sensor A	Sensor B	Sensor C	Sensor D	Sensor E	Sensor F	Sensor G
500 A Accuracy	5	1	6	7	2	4	3
5% Linearity	6	2	5	4	1	7	3
Rotational	2	1	5	7	3	6	4
Positional	N/A	2	5	3	1	4	N/A
End Effects	4	2	7	5	1	3	6
Over Rated	6	5	2	3	7	4	1
Stray Fields	4	3	7	6	2	5	1
Distortion	3	1	N/A	2	4	6	5
Temperature	2	1	4	5	6	7	3
Frequency	2	3	6	1	5	7	4

When a sensor is limited in resolution, it is assumed to have a performance level within half the resolution. For example with zero error, limited in resolution to 1 A, is assumed to have a performance of 0.5 A and would therefore be rated lower than another sensor with an error for example of 0.4 A.

The comparison applies only to the measurements points used. For example a Sensor that appears to best perform over the tested temperature range given in this report, will not necessarily best perform over a wider temperature range.

The comparison does not account for the influence of one parameter on another. For example the rotational errors for any given sensor may be different in the presence of stray fields.

The above ranking is based on the measurements performed during the trial and does not carry any implication as to the long term stability of the sensor / measurement system. Furthermore the measurements are a “type test” and it is assumed that the sensor system supplied is representative of all sensors of that given type.

6 CONCLUSIONS

This report describes the intercomparison of seven Class 1 non-invasive current sensors. Each Section of the report describes the testing method used for a different measurement parameter and results are given. For conclusions on the performance of the sensors for each individual measurement parameter the reader should refer to the *commentary on the results* Section. A summary Table is given in the previous Section which ranks the sensors for each parameter.

As the sensors are intended to be used as Class 1 devices it is useful to consider their performance in the context of a target error of 1 % (although Class 1 CTs are not tested to this range of parameters). In most cases the sensors have errors less than 1 % for the parameters tested, however Table 10 in Section 5 highlights the exceptions. It should be noted that even if a given sensor has errors less than 1 % for all individual parameters tested, the combination of errors could exceed 1% when used in practice.

Appendix B – Individual Manufacturer Assessment

1 Introduction

This appendix has been included to give a detailed overview of the installation and testing experience by manufacturer. Each system has been evaluated on the following criteria.

- Product Assessment
- Installation Experience
- Powering and Commissioning Unit
- Data Collection
- Laboratory Testing
- Reliability
- Improvements Implemented Since Testing
- Conclusion

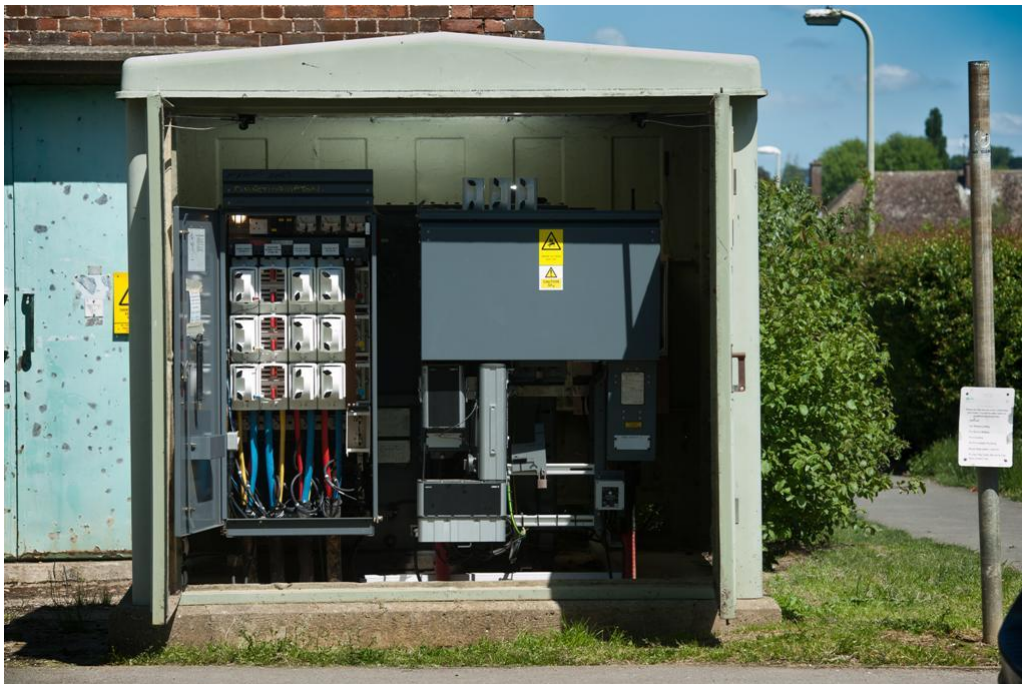

LV SENSORS**2 GMC i-Prosyst****2.1 Company Background**

GMC i-Prosyst was founded in January 2008 and are located in Skelmersdale (Lancashire), North West England. They specialise in the design, development and manufacture of current probes, clamp meters, handheld instruments and systems for current and voltage measurement, as well as measurement and processing of electrical parameters.

The monitoring solution used for this trial was developed in conjunction with Nortech, a Worcestershire based company specialising in web based telemetry and remote monitoring projects for utilities and related companies.

2.2 Product Assessment

GMC i-Prosyst in partnership with Nortech provided the sensors and metrology unit. The Rogowski coil sensors are able to measure three phases and neutral current and the design allows for easy installation around cable cores which have little spacing between them due to their thin profile. The bundling of the sensor cables into one connector also makes for good cable management and easy connection to the metrology unit provided.



Figure 1: Rogowski coils with single screw on connector from GMC i-Prosyst.



Figure 2: GMC i-Prosys metrology unit installed in outdoor substation. (WPD)

The metrology unit has a metal casing which is IP50 rated. For units with metal cases installed inside substations which are termed as Hot from an earthing perspective it is recommended to have separate neutral and earth or use an isolation transformer to supply power to the unit and use the HV earth to earth down the casing. The sensor connectors, which are of the screw type, are located at the bottom of the unit and these are easy to plug the sensors into. The metrology unit allowed for monitoring of up to 4 LV ways, although this was expandable to cater for up to 8 LV ways. There is also a temperature sensor provided with the metrology unit to measure the ambient air temperature of the substation. This is particularly useful when considering installation in indoor substations built in basements with poor ventilation where air temperature can be high leading to the degradation of the transformer if it is allowed to run hot for a prolonged period. The accuracy of this sensor was not tested during the laboratory or field trials. The SIM card slot is easily accessible to allow the SIM cards to be changed without powering down the unit.

2.3 Installation Experience

The GMC i-Prosys sensors and metrology unit was the easiest to install because of the plug and play nature of the unit. The sensors were able to fit around cores with little spacing between them as can be seen from figure 3. The only downside of the metrology unit is its physical size and weight although this can be remedied by enclosing the electronics inside a more compact casing if the DNO requested. For the WPD installed units, the weight of the units meant that a separate steel framework had to be utilised as the external fencing around the sites could not be utilised.



Figure 3: GMC i-Proslys Rogowski coils installed around tightly spaced cable cores.

2.4 Powering and Commissioning Unit

The power and 3 phase voltage reference for the metrology unit was obtained via the use of modified fuse carriers by UKPN and voltage clamps by WPD. The installation of both was straight forward and did not require an outage on the LV board. The part of the network that UKPN installed the unit in is LV interconnected so no linking and fusing exercise had to be undertaken to swap the regular fuse carrier for the modified ones. Also WPD were able to install the clamps live on the LV board bus bars using live working equipment.

The metrology units are self-commissioning so once they were powered on they communicated back to the iHost server hosted by Nortech. The indicator lights on the inside of the unit door assisted the installer in gauging whether the unit had been commissioned successfully or not.

2.5 Data Collection

The monitoring unit used the DNP3 protocol and communicates back via GPRS over the GSM mobile network. The data is communicated back to the iHost server where it can be accessed via secure login on a website. The data can be collected with intervals between 60 seconds and up to 60 minutes.

2.6 Laboratory Testing

The results of the laboratory testing are detailed in the NPL Report, TQE 8, under Sensor ID D.

The sensor was evaluated over a different number of tests. The flexible sensor was easy to connect/reconnect.

Linearity Tests: Departures from nominal to be less than 1% down to 5% of full scale.

Rotational / Positional Tests: Sensitivity to rotation / Position – Maximum spread greater than measurement uncertainty.

Conductor End Effects: A spread of less than 1% of reading observed.

Over Rated Current Tests: Change to the pre and post readings was less than the measurement uncertainty.

Stray Fields Tests: Changes observed greater than the measurement uncertainty indicating that there is some effect.

Distortion Waveform: Changes observed less than the measurement uncertainty.

Temperature Tests: 1.1% change across the range.

Frequency Tests: 3.3% error change from 50 Hz at a frequency of 100 Hz.

2.7 Reliability

The reliability of the equipment was good and there were no additional site visits that needed once the units were commissioned. There was on-site support available if the DNO requested it as the company is based in the UK.

2.8 Improvements Implemented Since Testing

There are a couple of firmware improvements that have been made to the unit: SD card logging, allows the data to be logged to a MicroSD card fitted to the Envoy RTU. Data is stored as zipped CSV files (one per day), and a 4GB card typically allows 3-5 years worth of data to be stored on site. This is very helpful for sites where there is no GPRS/3G available, or there are GPRS/3G outages.

In addition there is now the ability to view data on Envoy LCD. Volts, amps etc can now all be displayed on the Envoy LCD. This is very helpful for doing on site commissioning checks, allowing installers to verify coils have been connected the right phases in the right order.

2.9 Conclusion

The GMC i-Prosys and Nortech unit offers a no-nonsense rugged approach to substation monitoring with flexibility provided by Rogowski coils, a solid cabinet, and proven web interface through Nortech's i-host. The use of bus-bar clamps added further options for connecting the power source, and the screw fit connections were some of the best tested. The ability to expand the unit to cater for 9 LV ways is welcomed and proved to be the most versatile from that perspective. On the down side the case was potentially too large for some scenarios but is being addressed by the manufacturer.

3 GridKey

3.1 Company Background

GridKey is a collaboration between Sentec, and Selex ES.

Sentec is a supplier of smart grid, metering and smart home technology based in Cambridge, UK. They have been involved in smart meter design for gas, water and electricity for over a decade, and worked with some of the largest names in the industry.

Selex is a global business with approximately 18,000 employees across the United Kingdom, Italy, United States, Germany, Turkey, Romania, Brazil, Saudi Arabia and India. The company specialises in the design, development, manufacture and integration of a wide range of sensor and data exploitation systems

3.2 Product Assessment

GridKey provided sensors and metrology unit along with voltage clamps and fused leads to use with the clamps. Two types of sensors based on Rogowski coil technology were supplied; one was a rigid Rogowski coil with a small aperture while the other was a flexible one with a wide aperture. The flexible sensor was used around phase cores which had very little spacing between them.



Figure 4: Rigid and flexible Rogowski coil sensors from GridKey. (UKPN)

The GridKey metrology and communication unit (MCU) had a slim and compact profile which meant that it could be fixed onto a wall with limited space or, in some circumstances, inside the door of an LV cabinet due to its insulated outer casing and weatherproof inner casing rated to IP65. A minor downside of the metrology unit is that the outer plastic cover hid the activity indicator lights and so without the removal of the outer cover field staff

LV SENSORS

cannot ascertain whether the unit is functioning or not. Another downside is the sheer number of wires that are coming into the metrology unit since each sensor has to be plugged in individually. There is however a grooved cable rail at the bottom via which the cables come into the unit helping somewhat with cable management.



Figure 5: Sensor cables and voltage/power cables coming into the metrology unit (WPD).

The metrology unit allows for the measurement of current flow on up to 5 LV ways, three phases and neutral on each way. It also has an optical port on the front for connection to a laptop for configuring or interrogating the unit at site.



Figure 6: The GridKey MCU with the sensors and voltage leads connected. (UKPN)

3.3 Installation Experience

The installers reported that both types of sensors were easy to install around the phase cores of the LV cables without causing damage to the insulation. The arrow markings on the sensors guided the installers as to which direction to point the sensors in for correct installation. And the rigid sensor provided the installer with confidence of correct installation through the ‘click’ sound it made upon closure.



Fig 7: Gridkey Gridhound sensors

For LV ways where there was little spacing between the phase cores the thin flexible Rogowski coils were used. The sensor cables for each LV way were colour coded and then bunched together using cable ties for cable management purposes. The MCU was also

LV SENSORS

straight forward to install onto the wall using the wall mounting brackets provided. The sensor cables were individually plugged into the metrology unit without any issue.

3.4 Powering and Commissioning Unit

In order to obtain the three phase voltage and neutral reference and power for the metrology unit G-clamps were placed on the exposed part of the LV Board bus bars and fused banana plug leads were used.



Figure 8: Voltage take off points and fused leads. (WPD)

In order to commission the unit and configure it with the names of the LV feeder ways a laptop was connected to the unit via an optical port. The entire process was without issue and commissioning was completed quickly. The indicator lights on the front of the metrology unit provided information as to the status of the unit and whether it was communicating back to aid the installer in commissioning the unit. Selex/Sentec provided on-site support during the installations due to being based in the UK. An issue with the SD cards, to do with their read/write speeds, came to light after the first installations on the WPD network. This was quickly fixed following an additional site visit and swapping over of SD cards with those with a high read/write speed. The reliability of the sensors and metrology units was good and no further visits needed to be made to fix any issues. UKPN did not face the same issue as the manufacturer had fixed this in the units they were provided.

3.5 Data Collection

For the project GridKey provided the SIM cards for the units. The SIM card slot is embedded inside the metrology unit and cannot be accessed unless the metrology unit is powered down and opened up. The data collected was communicated back to GridKey's database

using a proprietary protocol via GPRS over the GSM mobile network. As mentioned above there is an industrial grade SD card inside the metrology unit, with high read and write speeds, to record the data in case the communication link to the database is lost, thus providing back up storage.

3.6 Laboratory Testing

The results of the laboratory testing are detailed in the NPL Report, TQE 8, under Sensor ID G.

The sensor was evaluated over a different number of tests. The solid sensor was relatively easy to connect / reconnect.

Linearity Tests: Departures from nominal to be less than 0.1% down to 5% of full scale.

Rotational / Positional Tests: Sensitivity to rotation - Maximum spread greater than measurement uncertainty. Sensitivity to position – No positional measurements possible as bus bar filled sensor aperture.

Conductor End Effects: A spread of less than 1% of reading observed.

Over Rated Current Tests: Change to the pre and post readings was less than the measurement uncertainty.

Stray Fields Tests: Changes observed less than the measurement uncertainty indicating that no significant effect could be detected.

Distortion Waveform: Changes observed greater than the measurement uncertainty.

Temperature Tests: Less than 1% change across the range.

Frequency Tests: 0.2% change in current reading from 50 Hz at a frequency of 100 Hz.

3.7 Reliability

The Gridkey units have generally performed reliably throughout the trial although one issue was highlighted through the project. Due to the high read / write frequency of the flash memory, the data storage card failed on the two WPD units. This fault was dealt with quickly by Gridkey who have modified the system operation to reduce the strain on the memory card, and also looked to source higher quality components. A series of tests were undertaken by Gridkey to test the amended solutions in simulations that mimicked several years of operation. This fault did not re-occur and it can be concluded that it should not occur in future installation.

UK based site support was available for all installations in this trial, and additional support to rectify the issues as they arose.

LV SENSORS**3.8 Improvements Implemented Since Testing**

Since the LV Sensors project began, some changes have been made to the GridKey system. All these have been made based on direct feedback from this trial and working with other UK DNOs

The Gridkey Metrology and Communications Unit (MCU) now has Ethernet functionality added to communicate data. This supports both dynamic (DHCP) and static IP addresses and it operates in parallel with the GPRS connection if desired.

The GridKey MCU has been upgraded to include THD Power in the data that it transmits back to a DNO, should it be required.

The bar that screws into the MCU and holds down the voltage leads and CT sensor cables has been removed in the new version. In some installations this was difficult to fit all the cables coming out of the MCU into the grooves at the base of the MCU and then to screw down the bar that holds them down. As such, in the latest version, there is a system where cables are tied directly to the unit using cable ties to hold all the CT sensor cables in place. The voltage leads are now secured by looping them around hooks on the unit which ensure that there is no risk of accidentally pulling them and therefore the power connector out of the MCU.

The GSM antenna cover and voltage connector cover that both screw onto the MCU now have molded seals injected directly onto them which has done away for the need for separate material to be placed onto the unit. This has no effect in its IP65 rating.

The GridKey team are open to exploring ways in which it can improve its offering and new versions of both the MCU and custom-designed Rogowski-style sensor are being developed with added benefits and functionality. In addition a more advanced data analytics toolset is being developed to better support DNOs in their operation, maintenance and planning decisions.

3.9 Conclusion

The Gridkey unit performed well in both field and laboratory testing, and was easy to install and commission. The addition of Rogowski coils to the unit have greatly improved the flexibility of the unit, although the standard Gridhound solid sensors were, on the whole easy to install. However on a number of sites, the small aperture did make closing the sensor difficult, especially where there was little space between phase conductors. The MCU is sufficiently small to allow installation in sites with little space, and the use of a non-metallic case allowed installation in close proximity to live conductors. The IP rating for the case will also allow installation in outdoor or damp environments. From an ergonomic perspective the unit has been well thought out with push fit connectors, commissioning indicators and a case hood to cover the connectors and flashing lights once installation has been completed.

4 Current

4.1 Company Background

CURRENT is a technology company based outside Washington DC. The organisation has operations around the world including in the United States, Switzerland, Spain, Portugal, Italy, France, Turkey, Romania, Czech Republic, United Kingdom, Australia, and China. For over a decade they have specialised in developing tools for the distribution grid through increased connectivity and analytics.

CURRENT was acquired by Ormazabal in March 2013, a company with a workforce of 1400 and an annual turnover in excess of 356 million Euros

4.2 Product Assessment

Current Grid provided two kinds of sensors based on Rogowski coil technology. There was a flexible blue sensor with a large aperture and a solid black sensor with a smaller aperture. Both sensors had their cable terminated with a USB interface. This made it easy for them to be connected to the metrology unit. The larger black plastic sensor proved difficult to install where cable cores were closely bunched, but it was recognised that the availability of a Rogowski coil was a welcome option for such circumstances. Each sensor was self-calibrating through an inline calibration unit manufactured into the sensor cabling.

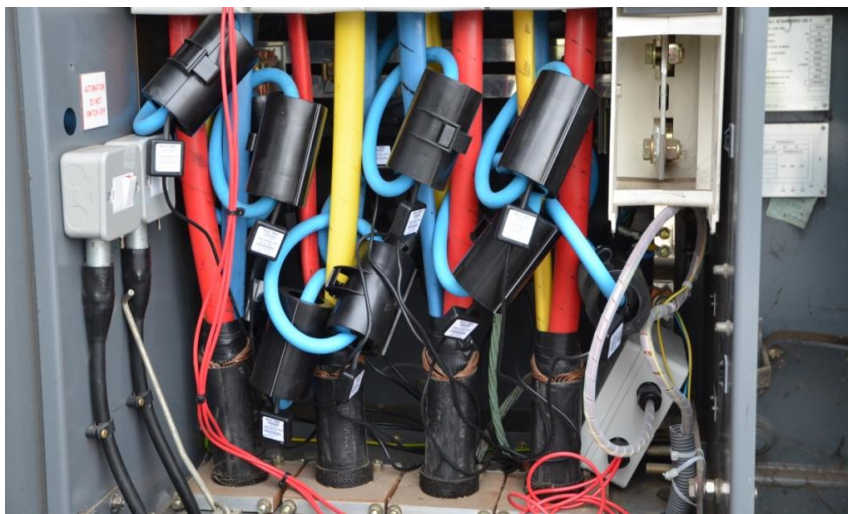

Figure 9: Blue Rogowski coils by Current Grid in congested LV cabinet. (WPD)

The metrology unit had a metallic outer casing and is IP21 rated. The unit is built in such a way as to be mounted sideways with indicator lights and connectivity and power ports on either side as can be seen from figure 10 below. The SIM card slot is embedded inside and having to replace a SIM card would require the unit to be powered down and the outer casing to be removed. A separate power box for the unit also had to be provided which was not the case with other manufacturers.



Figure 10: Current Grid metrology unit. (WPD)

4.3 Installation Experience

It should be mentioned that although the black rigid Rogowski coil sensor provided by Current Grid was tested at NPL but these could not be used for some of the installations due to the bulky nature of the sensors. The spacing between and the length of the phase cores available to install on at both WPD's and UKPN's substations meant that the blue flexible Rogowski coils had to be used. These were easy to install and there was a good length of cable on the sensors to allow flexibility of placement of the metrology unit in the substation. As mentioned before the USB connectors at the ends of the sensor cables were easy to plug into the metrology unit and there was not issue encountered during the installations.

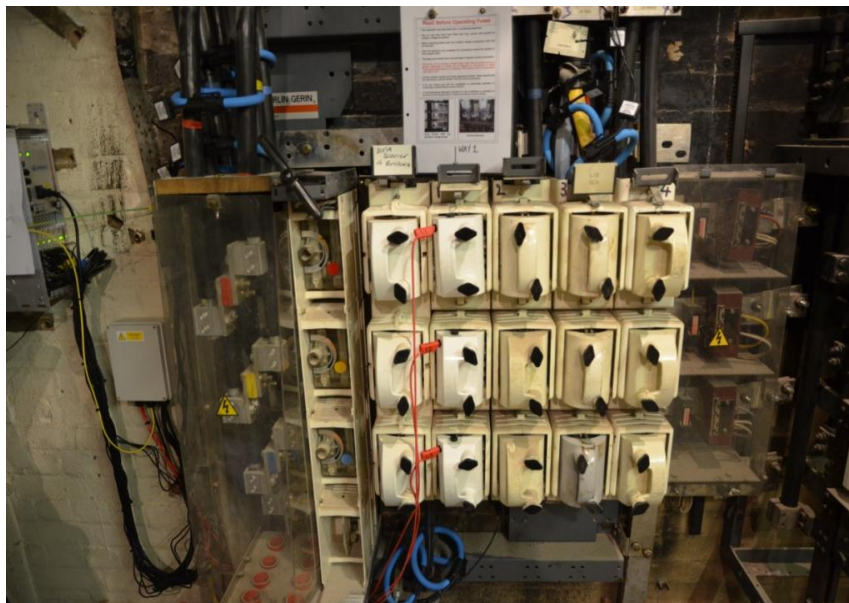

Figure 11: Current Grid monitoring solution installed in UKPN substation.

LV SENSORS**4.4 Powering and Commissioning Unit**

The power and voltage reference for the metrology unit was obtained via the use of modified fuse carriers. Once powered up the metrology unit is self-commissioning and connected to the Grid On server to indicate the device is online. The indicator lights on the side of the metrology unit also assured the installer that the unit had commissioned successfully. The reliability of the sensors and metrology unit were good and no additional site visits needed to be made. There was on-site support available from Current Grid as despite being a US based company they have a local support person in the UK.

4.5 Data Collection

Data collection by the metrology unit could be configured so that data could be sent back at various time intervals. Data was sent back over the DNP3 protocol via GPRS on the GSM network to the Current Grid server and it could be viewed through secure access on the GridOn web-based software developed by Current Grid. This was the most advanced and developed software seen in the trial and offered high levels of power quality analysis and asset management functionality. The additional functionality was significantly over and above the basic substation monitoring that was envisaged for this trial.

4.6 Laboratory Testing

The results of the laboratory testing are detailed in the NPL Report, TQE 8, under Sensor ID B.

The sensor was evaluated over a different number of tests. The solid sensor was easy to connect/reconnect.

Linearity Tests: Departures from nominal to be less than 1% down to 5% of full scale.

Rotational / Positional Tests: Sensitivity to rotation – No significant rotational effect. Sensitivity to position - maximum spread greater than measurement uncertainty.

Conductor End Effects: Spread is comparable with measurement uncertainty and therefore can be deemed to have no significant end-effect.

Over Rated Current Tests: Change to the pre and post readings was less than the measurement uncertainty.

Stray Fields Tests: Changes observed less than the measurement uncertainty indicating that no significant effect could be detected.

Distortion Waveform: Difference between both waveforms less than measurement uncertainty.

Temperature Tests: Least change of all sensors across the range, the maximum change being less than the measurement uncertainty.

LV SENSORS

Frequency Tests: Less than 0.1% error change from 50 Hz at a frequency of 100 Hz.

4.7 Reliability

The equipment performed well and required one site visit to reset a installations when a unit locked up. An additional site visit was also required to improve the mobile phone aerial, but this was primarily due to poor signal strength from the mobile phone provider. UK based support staff was available and able to respond to issues swiftly

4.8 Improvements Implemented Since Testing

At the installation training held at the UKPN training centre in Sundridge, Current Grid had been made aware that the bulky rigid black Rogowski coil would be difficult to install around the LV core. This was due to the limited space available between the LV cores combined short cable termination.

Current have subsequently developed a slim line rigid Rogowski sensor, with a much smaller foot print but slightly wider aperture. The project also helped to contribute to the development of a low cost transformer monitor, a smart transformer monitor that's focused on overall substation data rather than feeder data

Although CURRENT have always produced a IP65 rated product for Overhead PMT installations it became apparent that there was a need for this product line be extended in order to ensure that 99% of installations can truly be "fit and forget" removing water ingress anxiety.

4.9 Conclusion

The Current Grid monitoring solution was probably the most advanced system tested as part of the trial. The end to end solution provided some of the best results in the lab testing and the web interface was very advanced and clearly capable of managing large volumes of units and data. The USB connectors made installation simple. However the case for the unit offered little or no protection from the elements, and would require installing in a separate weather resistant case. In addition a separate joggle box was required for the power cable making the installation more time consuming.

5 PowerSense

5.1 Company Background

PowerSense A/S was founded September 1, 2006, as a spin-off from the Danish power company DONG Energy (dongenergy.com) and the Danish venture capital fund NES Partners (nespartners.dk). The PowerSense HQ is located in Copenhagen, Denmark, with many years of experience in product development, grid operation and international partnerships. Today, PowerSense works with major power companies throughout Europe, the U.S., Asia Pacific and South America.

5.2 Product Assessment

PowerSense provided split core CTs along with their DISCOS I/O module encasing the metrology and communication electronics in a plastic box. The split core CTs have a shorting link in them which prevent any dangerous voltages appearing between the terminals upon installation around an LV conductor. The link needed to be removed by the installer once the CT has been securely closed otherwise it will prevent the CT from functioning properly.



Figure 12: PowerSense split core CTs around LV phase cores (WPD).

The DISCOS metrology unit had a compact plastic box enclosure and allowed for up to 4 LV ways to be monitored. The metrology box contains a battery for back-up power. The sensor and power cables entered the unit from the bottom while the antenna was mounted on top of the unit. The unit uses a high read and write speed industrial grade SD card to hold the software and also the data collected. The SIM card slot is easily accessible and the SIM card can be replaced without having to power down the unit. The DISCOS unit also had a number of indicator lights on the outside to show the status of the electronics and communication link.



Figures 13: Internal components of the DISCOS I/O metrology unit from PowerSense. (WPD)

5.3 Installation Experience

The PowerSense split core CTs had to be opened up by inserting a flat head insulated screw driver into a slot on the side and wedging it open. This method of opening up the CT presented a safety risk to the engineer replacing a faulty CT. The CT did make a 'click' sound assuring the installer that it had been securely closed. Upon installation of the split core CT the shorting link had to be removed to allow the CT to function properly. Each CT cable had to be brought into the DISCOS unit and wired up into the data aggregation board as can be seen from figure 13 above. Due to the manual wiring that had to be done the connection of the CTs to the metrology unit was a time consuming process, and pushing the cables through the rubber glands was often difficult. Where cables cores were closely bunched, it was difficult to install the CTs due to their bulky nature and rigidity. This often resulted in the sensors being pushed up the cable, often encroaching on live areas of the LV pillar. This was deemed to be less than ideal.



Figures 14: Example of CT installation high up cables due to spacing restrictions. (WPD)

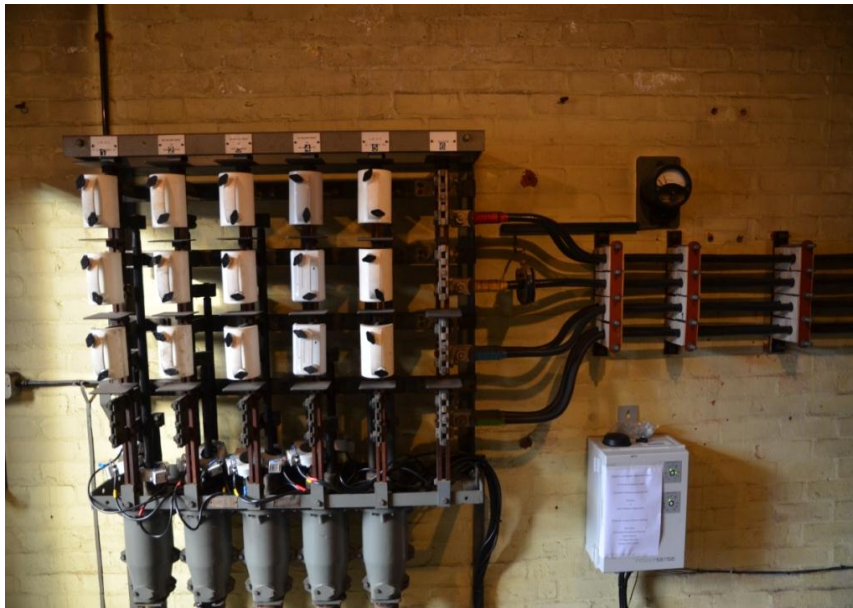

Figure 15: Installation of CTs and DISCOS metrology unit from PowerSense. (UKPN)

5.4 Powering and Commissioning Unit

The unit was powered via the RTU fuses (UKPN) and substation test points (WPD) which also provided the voltage reference. Once the unit was powered on it was self-commissioning and did not require any calibration on site to be carried out. Both UKPN and WPD provided SIM cards for the units installed. The indicator lights on the front of the metrology box

indicated that the commissioning had been successfully completed and a communication link has been established by going green and blinking.

5.5 Data Collection

The system can be configured to gather data between 5 to 60 minute intervals and is stored in the SD card before it is transmitted back over DNP3 protocol via GPRS. There was also a buffer facility built into the metrology unit that would store data upon loss of communication link with the data server and is limited by the memory of the SD card.

5.6 Laboratory Testing

The results of the laboratory testing are detailed in the NPL Report, TQE 8, under Sensor ID F.

The sensor was evaluated over a different number of tests. The solid sensor was rated as difficult to connect / reconnect due to the need to use a screw driver to prise the CT open each time.

Linearity Tests: Departures from nominal to be greater than 1% down to 5% of full scale.

Rotational / Positional Tests: Sensitivity to rotation / positional – Any effects were masked by the low resolution.

Conductor End Effects: No spread seen due to the low resolution.

Over Rated Current Tests: Change to the pre and post readings was less than the measurement uncertainty.

Stray Fields Tests: Changes observed less than the measurement uncertainty indicating that no significant effect could be detected.

Distortion Waveform: Changes observed less than the measurement uncertainty.

Temperature Tests: No change across the range within the limited resolution.

Frequency Tests: No observed change in current reading from 50 Hz at a frequency of 100 Hz which was primarily down to resolution of the sensor.

5.7 Reliability

Overall the reliability of the sensors and metrology unit was good, although for one of the units UKPN installed an additional site visit had to be made to fix an issue with an internal connector coming loose during transportation of the unit from Denmark to UK.

5.8 Improvements Implemented Since Testing

PowerSense has updated the internal protocol used in the DISCOS® System to a purely event driven operating system, leading to improved flexibility, measurement resolution and system operation. They also provide a range of options for external protocols including XML, IEC60870-5-104 and DNP3 on the one RTU.

Data points can be added or removed allowing customers to select a subset of values (I, V, P, Q) for a particular site. The changes can easily be completed using traditional SCADA processes. There is also improved processing and registration of events and alarm driven reporting. Due to the improved time stamping it is now possible to examine data down to a resolution of 0.1ms. The new protocol also introduces real-time values to the solution leading to a refresh rate of 2s at maximum depending on number of modules on one system.

PowerSense have also developed the DISCOS® LV Satellite box to improve the options available for retrofit installations. This includes the choice of Rogowski coils as an alternative to split-core current transformers. Rogowski coils are now provided for installations where space between individual feeder phases is limited and high flexibility is needed. For ease of installation, PowerSense is now also providing both CTs, Rogowski coils and the DISCOS® System itself with plug-in connectors. This means that you don't have to open the box to make the installation or commission the system.

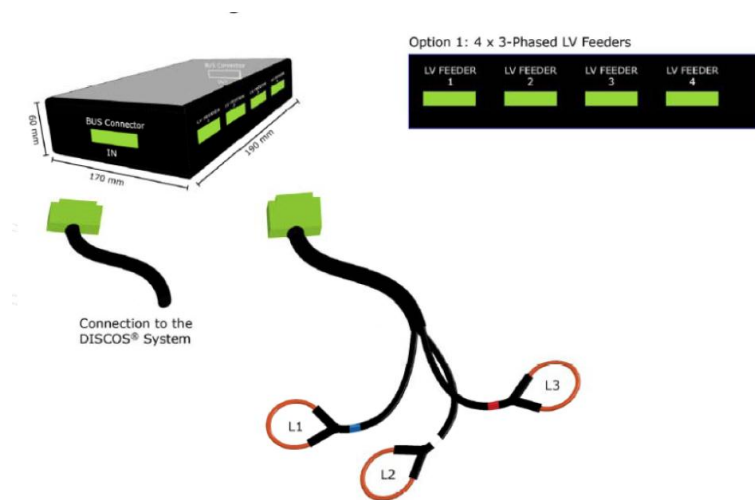

Figure 16: PowerSense LV satellite box and Rogowski coils

5.9 Conclusion

The DISCOS unit is a well-conceived piece of equipment with a range of useful indicator lights. The box feels rugged and is well suited for both indoor and outdoor applications. The CTs used for this trial did present some challenges in installation due to their bulky nature and manual wiring process which was time consuming.

6 Ambient

6.1 Company Background

Founded in 1996, Ambient has been focused on the collaborative development of smart grid technology and communication solutions since 2000. Ambient is headquartered in Newton, Massachusetts with a satellite office in Europe.

6.2 Product Assessment

The monitoring unit provided by Ambient came with CTs, a metrology unit and wall mount bracket. The CTs had a plastic shell and the leads terminated with TNC connectors for easy connection to the metrology unit. The aperture of the CTs is small with a thick outer boundary as can be seen from figure 17 below. This makes them unsuitable for installation around tightly spaced phase core conductors especially where the length of cable available to install on is short. There was also concern around the lack of a shorting pin with the CTs. This meant the CTs would need to be connected to the metrology unit before being installed on the LV board.



Figure 17: Ambient split core CT.

The metrology unit only allows for 3 CTs to be connected and so one unit is required to monitor 1 LV way. This was a significant downside of the Ambient solution and meant that space for mounting the additional metrology units on the wall had to be considered when selection a suitable substation. The metrology unit had a plastic outer casing which was weatherproof and NEMA-4 (American standard) rated. This made it suitable for mounting on poles and outdoor substations.



Figure 18: Ambient metrology box and connector ports.

6.3 Installation Experience

The installation of CTs was straight forward but only those LV ways could be installed on where the core conductors had sufficient spacing between them as can be seen from figure 19 below. One of the LV ways could not be installed on with these CTs because of this restriction. The CTs were bi-directional so it did not matter which way they were pointing when installed. They were labelled up to designate which CT went around which phase to assist the installer. Closure of the CTs was accompanied with a positive click confirming a correct installation.



Figure 19: Ambient CTs around core conductors on an open LV board. (UKPN)

LV SENSORS

One metrology unit had to be used for monitoring one LV way. This meant that sufficient space needed to be available in the substation to mount the metrology units despite the compact nature of the units. This especially became a concern where multiple LV ways (up to 5) needed to be monitored. The metrology units were straight forward to mount using the brackets supplied. And connecting up the sensors and power/voltage reference leads was also very straight forward.



Figure 20: Ambient metrology units, one for each LV way. (WPD)

6.4 Powering and Commissioning Unit

The need to have multiple units for monitoring several LV ways meant that providing power and voltage take off for multiple boxes required a power marshalling box to be made where modified fuse carriers or G-clamps were used. This also meant that a larger fuse size was required since the power requirements were higher. In one installation, the inrush current was sufficient to cause the fuses to blow in the modified fuse carrier handles. Subsequently slow blow fuses were installed to negate this effect on powering up the units.

Once powered up the metrology units were self-commissioning although the lack of status indicator lights on the exterior of the casing meant that the installer could not ascertain that commissioning had been completed successfully. Ambient's support helpline had to be called to check if the units were communicating with their server. The overall reliability of the sensors and metrology units was good and no additional site visits had to be made.

6.5 Data Collection

The units can be remotely configured to measure data at various time intervals and the software on these can also be remotely upgraded. The data is communicated back to the server over the DNP3 protocol via GPRS over the GSM network. There is a data buffer facility available which can store data when the communication link is lost and upon restoration of the link can send through the stored data. The sim card is embedded inside

the box and if it needs to be changed will require the box to be powered down and opened since the box is weather sealing.

6.6 Laboratory Testing

The results of the laboratory testing are detailed in the NPL Report, TQE 8, under Sensor ID A.

The sensor was evaluated over a different number of tests. Although the sensor was quite difficult to open, once closed was secure.

Linearity Tests: Departures from nominal to be less than 2% across the range.

Rotational / Positional Tests: Sensitivity to rotation – Maximum spread greater than measurement uncertainty. No positional measurements possible as bus bar filled sensor aperture.

Conductor End Effects: A spread of less than 1% of reading observed.

Over Rated Current Tests: Change to the pre and post readings was greater than 0.1%.

Stray Fields Tests: Changes observed greater than the measurement uncertainty indicating there is some effect.

Distortion Waveform: Less than 0.2% of reading between both waveforms.

Temperature Tests: Less than 1% change across the range.

Frequency Tests: Less than 1% error change from 50 Hz at a frequency of 100 Hz.

6.7 Reliability

The units have performed well on the whole. Initial issues with powering up the devices were soon traced to the loss of fuses in the modified fuse carrier handles. One other unit had initial issues that required the visit from a support engineer. This was soon rectified and primarily linked to poor mobile phone signal strength.

6.8 Improvements Implemented Since Testing

Initial feedback at the installation training in Sundridge was provided to Ambient about the DNO's concern around their CT and limitation of the metrology unit to monitor only 1 LV way. Ambient have since developed their M-PQM – Multi Feeder Power Quality Monitoring Solution. This allows the monitoring of up to four feeders on a single metrology and communications unit. An additional Separate Sensor Distribution Unit has been introduced with optional lengths of cable to fit in small places and allow positioning of comms unit

LV SENSORS

(Node) elsewhere. In response to concerns regarding sensor dimensions, a Rogowski Coil solution has also been included in the suite of options.

A number of enhanced Power Quality parameters are now available, in addition to the standard monitoring parameters. These include power factor, Total Harmonic Distortion (THD) for voltage and current combined with individual harmonics of 2nd order, 3rd order, etc. up to 60th order. There is the ability to monitor neutral currents, detect voltage sags and set over-voltage and over-current thresholds per phase. Ambient now claim an accuracy of 0.5% or better.

Additional improvements include

- A new link box solution for single feeder applications
- MV PLC communications for underground locations
- Full DNP3 and IEC 61850 aggregation

6.9 Conclusions

The Ambient units are very well manufactured and robust for both indoor and outdoor applications. The CTs were simple to install, although did struggle where there was minimal spacing between cable cores. The screw fit connectors were simple to use easy to connect. However, the main disadvantage for the trial was the use of multiple units for substations. This has now been addressed in the latest incarnation of the product.

7 Haysys

7.1 Company Background

HAYSYS Ltd is an Electronic Design Services company based in Cardiff, South Wales. Their customers include the UK Ministry of Defence where they are established as a Prime Contractor, providing design services for systems used by the Royal Air Force. Haysys also provide design and manufacturing services to the Power Distribution industry.

7.2 Product Assessment

The Haysys monitoring solution came with Rogowski coils and a metrology unit. The metrology unit had data aggregator boards inside which summated the measurements of the Rogowski coils and fed that into an EDM1 Mk10A power meter to give the total substation load. The flexible Rogowski coils were slim and had a large aperture which made it easy to manipulate the coil around the conductor and their placement around large cables. The Rogowski coils had open ended leads without any connectors.



Figure 21: Haysys flexible rogowski coil.

The metrology unit provided by Haysys had a plastic outer casing. The EDM1 Mk10A power meters were provided by WPD and the SIM cards were embedded inside the meters.



Figure 22: Data aggregation electronic boards and EDM I Atlas Mk10A meter inside the Haysys metrology unit.

7.3 Installation Experience

The installation of the Rogowski coils onto the LV ways was straight forward but connecting them up to the metrology unit was time consuming and required patience as each bare metal termination of the Rogowski coil (12 coils in total) had to be connected into a wiring loom using a screw driver as can be seen from figure 23 below. This was made more time consuming with one of the WPD installations where cables had to be extended. However it should be recognised that this could be avoided by specifying a longer cable to start with.

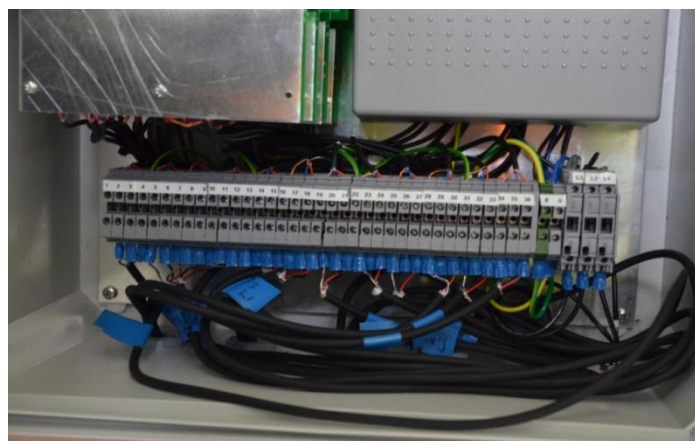

Figure 23: Rogowski coils wired into loom. (WPD)



Figure 24: Haysys monitoring solution installed in substation. (UKPN)

7.4 Powering and Commissioning Unit

The power and three phase voltage reference for the unit was obtained through various means like via modified fuse carriers or off the RTU fuses in a substation. Once powered on the unit was self-commissioning and did not require any on-site configuration. The status indicator lights inside the metrology unit helped confirm when the unit was successfully commissioned.

7.5 Data Collection

The intervals at which data could be collected was dictated by the EDM1 Mk10A power meter and could only be changed through on-site interrogation of the unit. Data was transmitted back to the Haysys server via GPRS over the GSM network. The power meter had a data buffer facility built in as well for data back up during communication loss.

7.6 Laboratory Testing

The results of the laboratory testing are detailed in the NPL Report, TQE 8, under Sensor ID C.

The sensor was evaluated over a different number of tests. The flexible sensor was easy to connect/reconnect.

Linearity Tests: Departures from nominal to be less than 1% down to 5% of full scale.

Rotational / Positional Tests: Sensitivity to rotation / Position – Maximum spread greater than measurement uncertainty.

Conductor End Effects: A spread of less than 1% of reading observed.

Over Rated Current Tests: Change to the pre and post readings was less than the measurement uncertainty.

Stray Fields Tests: Changes observed greater than the measurement uncertainty indicating there is some effect. This change was also greater than 1%.

Temperature Tests: No change across the range within the limited resolution.

Frequency Tests: 1% error change from 50 Hz at a frequency of 100 Hz.

7.7 Reliability

These units worked first time with no further need to revisit the sites.

7.8 Improvements Implemented Since Testing

The DNOs had made Haysys aware of the limitation of their metrology unit as it only allowed for the monitoring of total load of the transformer rather than the individual LV ways. Haysys were also made aware of the sheer amount of wiring that had to be done to connect the Rogowski coils to the metrology unit and it was recommended that they adopt the use of push fit or screw fit connectors for their sensors like other manufacturers have. Haysys successfully took those recommendations on board and have created a monitoring solution that has a small foot print and uses screw fit connectors while minimising the amount of wiring for cable management purposes.

7.9 Conclusion

The Haysys unit was a rather basic affair with many of the ergonomic refinements of rival products missing. However the units have performed well and are returning data to a well-constructed web interface.

LV SENSORS**8 Locamation****8.1 Company Background**

Locamation was founded by graduates of the Twente University of Technology in 1983. Locamation started by developing industrial control and real-time software, moving into high-voltage substation automation in the early 90s.

8.2 Product Assessment

Locamation had originally supplied a split core CT that was held together using a rubber strap. This was discounted from the installation trial on safety grounds as it was particularly difficult to install and half of the CT core was an un-insulated metal hoop that could come out of the unit completely. As the intention was to install these on live LV board and pillars, it was agreed this presented a safety risk and an alternative was presented. While this still had some exposed metal it was firmly enclosed in a plastic cover and less likely to come apart and the slightly raised inner edges of the plastic around it significantly reduced the risk of a flashover.

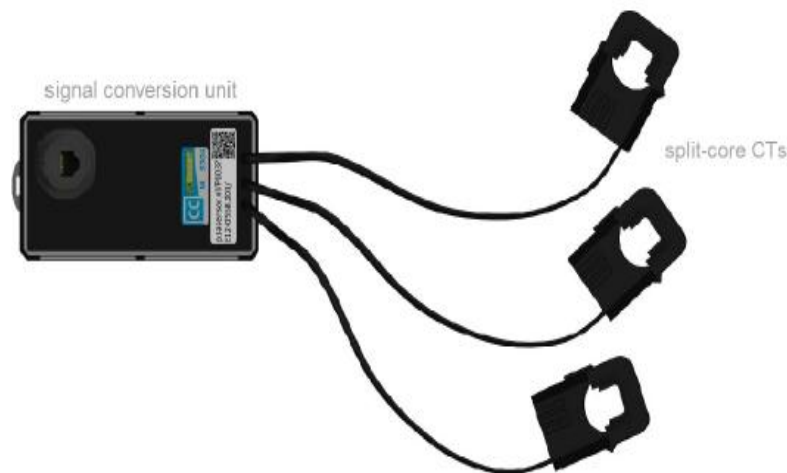

Figure 25: Split core CTs from Locamation.

The 3 CTs were connected up to a data aggregator and the data aggregator could then be connected up to the metrology unit using a RJ45 LAN cable. The CTs were well marked up to indicate which direction to install them around the conductor.



Figure 26: Locamation metrology unit. (UKPN)

The metrology unit had a compact metallic build and all the connector ports were located at the bottom of the unit. There were no indicator lights on the outside of the box so the only way to ascertain that the unit was powered up and working properly was by opening the door and looking at the status lights inside. The metrology unit was supplied with a single lead for voltage reference take off and power supply. This meant that only single phase voltage reference could be obtained for the power calculations. The units did however have the capability to take 3 phase voltage reference. The SIM card slot was easy to access and did not require the unit to be powered down if the SIM card needed changing. The metrology unit allowed for the monitoring of up to 4 LV ways.

8.3 Installation Experience

The split core CTs supplied were a tight fit around the core cables due to their small aperture. They made a 'click' sound upon closure around a conductor to assure the installer that they had been installed correctly. There were orientation arrows and phase (L1/L2/L3) marking on the CTs to assist in their correct installation. For the UKPN installations there were two scenarios which prevented the CTs from being installed on LV ways. The first was where there was not enough length of exposed core cable providing enough distance for spacing out the CTs. The second was when the spacing between the cores was not sufficient.



Figure 27: Locamation split core CTs around individual phase cores. (UKPN)

The metrology unit was easy to mount on the wall using the brackets provided. And due to its compact size would be ideal for substations with limited wall space. The CTs were also easy to connect to the unit due to the use of RJ45 LAN cable connectors and since there was one cable per LV ways this made cable management easier too.

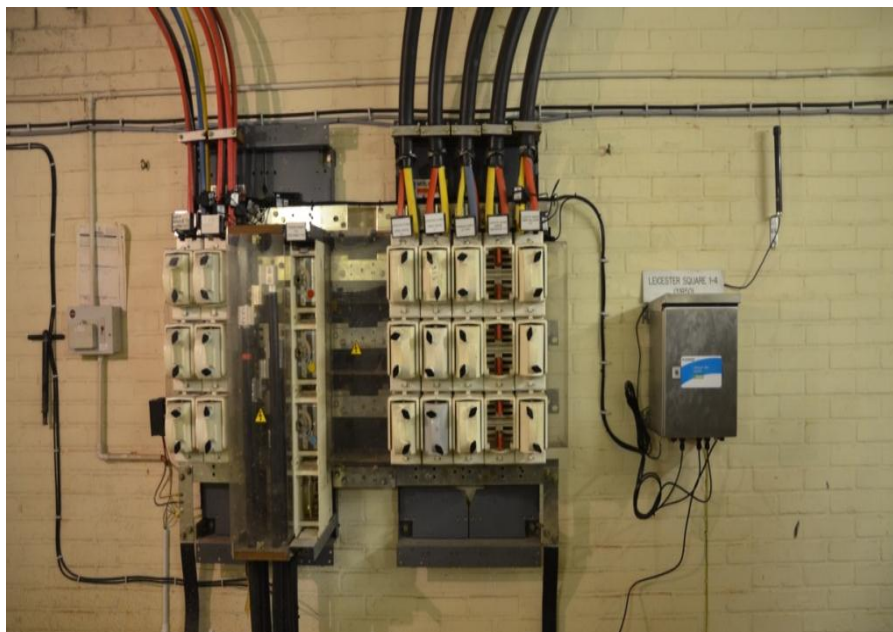

Figure 28: Locamation monitoring unit installed in a substation. (UKPN)

8.4 Powering and Commissioning Unit

The monitoring units that both UKPN and WPD were supplied with could only take a single phase voltage reference and came with a standard UK power plug. Only at one installation

was the power plug used while at the other three sites the plug head was removed and the lead ends connected to a clamp with an inline fuse for protecting the lead.

Once the unit was powered on it is designed to be self-commissioning with no calibration required at site. There were however issues during the commissioning of the units as they did not communicate back to Locamation's data server. In order to fix the issue the SIM card settings had to be changed and then during additional site revisits the units had to be restarted for the settings changes to take effect. Once this was done the units started to communicate back correctly. The status indicator lights inside the unit helped the installers check if the commissioning had been successful or not.

8.5 Data Collection

The collection of data can be set to various time intervals depending on the requirements of the user. There is local storage of data before it is transmitted to Locamation's server over the DNP3 protocol via GPRS/3G over the GSM/3G network. There is a data buffer facility which stores the data if there is a loss of communication with the server.

8.6 Laboratory Testing

The results of the laboratory testing are detailed in the NPL Report, TQE 8, under Sensor ID E.

The sensor was evaluated over a different number of tests. The solid sensor was relatively easy to connect / reconnect.

Linearity Tests: Departures from nominal to be around 0.2% down to 1% of full scale.

Rotational / Positional Tests: Sensitivity to rotation - Maximum spread greater than measurement uncertainty. Sensitivity to position – No significant positional effect.

Conductor End Effects: A spread of less than 1% of reading observed.

Over Rated Current Tests: Change to the pre and post readings was greater than 0.1%.

Stray Fields Tests: Changes observed less than the measurement uncertainty indicating that no significant effect could be detected.

Distortion Waveform: Changes observed greater than the measurement uncertainty.

Temperature Tests: 1.8% change across the range.

Frequency Tests: Less than 1% error change from 50 Hz at a frequency of 100 Hz.

8.7 Reliability

All four units tested in this project required revisiting by the manufacturer to resolve performance issues. These ranged from software issues, through to hard ware malfunctions.

LV SENSORS

From a commissioning perspective this meant that each unit had to be commissioned by the vendor, which from a wider deployment perspective would prove impractical.

8.8 Improvements Implemented Since Testing

In response to the project tender, Locamation put together a proposal for a number of prototype monitoring units to meet the specification. This was a departure from their existing expandable modular design. As these were prototype units, this inevitably led to a number of failures during installation.

At the installation training session in Sundridge strong reservations were raised regarding the split core CT where the metal hoop was held together with a rubber strap. Locamation responded by providing split core CTs with a fixed hinge mechanism and plastic shrouding over the metallic hoop. They have also developed facilities to accommodate both CT's and Rogowski coils dependent upon the physical arrangement on site.

Since the start of the trial, Locamation have developed their standard LV offer to include an intelligent operating platform to create a Distributed Intelligence Unit. A number of other areas are being addressed in response to this trial; local data management, consolidation, handling and storage to prevent data flooding issues, as well as identifying the key business drivers for adoption of distributed intelligence, i.e. reduction in reinforcement costs, power quality management, event recording and alarming by exception.

8.9 Conclusion

The product tested as part of this evaluation was housed in a good sized enclosure with simple screw fit connections. However, this product was let down by software and hardware issues and had the feel of a test unit rather than a finished product.

ENGINEERING OPERATING STANDARD

EOS 01-0053

**INSTALLATION AND OPERATION OF MONITORING EQUIPMENT
ON LV DISTRIBUTION EQUIPMENT**

Network(s): EPN, LPN and SPN

Summary: This engineering operational standard covers various Innovation Project Trials that require voltage and current measurements on LV distribution boards.

Originator(s): Ross Thompson / Omer Khan **Date:** 15/11/2012

Approved By: Barry Hatton **Approved Date:** 11/01/2013

Review Date: 10/01/2014

This document forms part of the Company's Integrated Business System and its requirements are mandatory throughout UK Power Networks. Departure from these requirements may only be taken with the written approval of the Director of Asset Management. If you have any queries about this document please contact the originator of the current issue.

Document History

(The document history notes below are intended as a guide only and may not cover all of the changes. If you wish to make use of this document it should be read in full.)

Version	Date	Details	Originator(s)
1.0	15/11/2012	Original	Ross Thompson/Omer Khan

Installation and Operation of Monitoring Equipment on LV Distribution Equipment

Document Number: EOS 01-0053

Version: 1.0

Date: 15/11/2012

Contents

- 1 Introduction**
- 2 Scope**
- 3 Definitions**
- 4 Site Selection**
- 5 Current Sensor Technologies**
- 6 Installation**
 - 6.1 Current Sensors
 - 6.2 Voltage Connection
 - 6.3 Signal Cable Management
 - 6.4 Communications Box.....
 - 6.5 Ellipse Asset Registration
- 7 Operation**
 - 7.1 Modified Fuse Carriers
 - 7.2 Current Sensors
- 8 Decommissioning**

Appendix A - Equipment For Use In Trials

Appendix B - Asset Registration Information

Appendix C - Example Operational Instruction Card

Installation and Operation of Monitoring Equipment on LV Distribution Equipment

Document Number: EOS 01-0053

Version: 1.0

Date: 15/11/2012

1 Introduction

It is anticipated that Low Voltage (LV) monitoring will become increasingly common as new network challenges (e.g. connection of distributed generation and Electric Vehicles) mean that a greater visibility of the LV network will be needed. This document specifically covers work for two projects:

- **LV Current Sensor Technology Comparison (managed by Omer Khan).** This project compares sensors from seven current sensor manufacturers. In addition to testing at the National Physics Laboratory, the project will involve installing each sensor technology with associated communications equipment at two secondary sites (14 sites in total) in the LPN area. These trials will inform future policy on how LV monitoring equipment is installed and used.
- **Validation of PhotoVoltaic Connection Assessment Tool (managed by Ross Thompson).** This project involves monitoring 20 distribution substations in the SPN and EPN areas with varying levels of photovoltaic (PV) generation connections. This will inform future planning processes for assessing the impact of connecting PV generation.
- **Low Carbon London Engineering Instrumentation Zones (managed by James Gooding).** This project involves monitoring the LV network in three specific geographical areas to assess the impacts of renewable energy devices and smart meters on the distribution network fed via Merton, Brixton B and Amberley Road Primary Substations. The programme is using the EMS subnet LV monitoring unit and Rogowski coils connected to substation LV Boards.

2 Scope

This document serves two purposes:

- To give advice on the main aspects to consider when preparing a work method statement for the installation of LV monitoring equipment, and ensure minimal impact on network operations;
- To detail the procedure(s) to follow when operating an area of the network that has been fitted with LV monitoring equipment.

It is extremely important to be aware that this document **does not** constitute a safe method of working for the installation of LV monitoring equipment. A method statement for all work must be prepared with guidance from this document, following the Distribution Safety Rules (DSRs) and HSS procedures detailed below.

The DSRs and all relevant DSR and Health, Safety and Sustainability (HSS) procedures shall be adhered to at all times. Work covered by this document must not be carried out if it does not comply with the **Distribution Safety Rules**, in particular section **8** and **DSR 01 019, DSR 01 020** and **HSS 40 045** relating to live LV working.

PPE in accordance with DSR 01 019 shall be required.

DSR 01 019	Work in the Vicinity of Live LV Boards etc
DSR 01 020	Connecting Cables to LV Boards
HSS 40 045	Basic Requirements for Live Working on Low Voltage Apparatus

Installation and Operation of Monitoring Equipment on LV Distribution Equipment

Document Number: EOS 01-0053

Version: 1.0

Date: 15/11/2012

3 Definitions

Term	Definition
4mm Plug	The method of making a voltage connection with modified fuse carriers detailed in appendix A
LV	Low Voltage
HSS	Health, Safety and Sustainability
DSR	Distribution Safety Rules
Modified Fuse Carrier	Standard fuse carrier with fused 4mm voltage connection.
CT	Current Transformer

4 Site Selection

LV boards vary significantly in design and cable termination arrangement. This will affect the way in which, if at all, monitoring equipment can be installed at a particular site. A site survey shall be carried out prior to installation to make a decision as to whether the site is suitable and, if so, which equipment and method should be employed for the installation.

Whenever possible, if modified fuse carriers are to be fitted the LV Network will be back-fed. This will avoid the need to interrupt customer supplies.

5 Current Sensor Technologies

Various current sensors will be installed as part of the projects and will measure current using one of two technologies; either Rogowski Coil or Current Transformer.

Current Transformers may require special precautions to be taken at the time of installation. The installer shall ensure they are aware of any precautions needed by identifying the type of sensor from Appendix A and following any instructions provided by the manufacturer.

If the current sensor is of a split core Current Transformer type (identified from Appendix A) care must be taken to ensure that the terminals are either connected to the measurement equipment or electrically shorted when the sensor is fitted to a load carrying cable. Failure to do this can lead to high voltages on the CT terminals that can cause damage to the device and also create a serious electric shock hazard.

Some current sensors are not rated as insulated sensors. In this case the sensors shall only be installed on parts of the network that are known to be insulated and extra precautions may be required during installation. Details on the insulation level of each sensor are stated in Appendix A.

Installation and Operation of Monitoring Equipment on LV Distribution Equipment

Document Number: EOS 01-0053

Version: 1.0

Date: 15/11/2012

6 Installation

Prior to the installation being carried out, a site specific Work Method Statement must be prepared that is specific to the equipment being installed. The information provided in this section should be used to guide the preparation of this Method Statement.

The method of installation should be generated such that the connection of voltage references and current sensors should be made as late in the process as reasonably practicable with the exception of tasks that rely on these connections being present.

6.1 Current Sensors

Current sensors will be of “split” type allowing them to be installed without disturbing the installed cables. These sensors may only be installed on the section of cable above the crutch of the cable termination and below the lowest fuse carrier (see Figure 1) where practicable. If this cannot be achieved further precautions must be taken and detailed within the method statement, and must not interfere with normal operational procedures within the substation. PPE in accordance with DSR 01 019 shall be required.

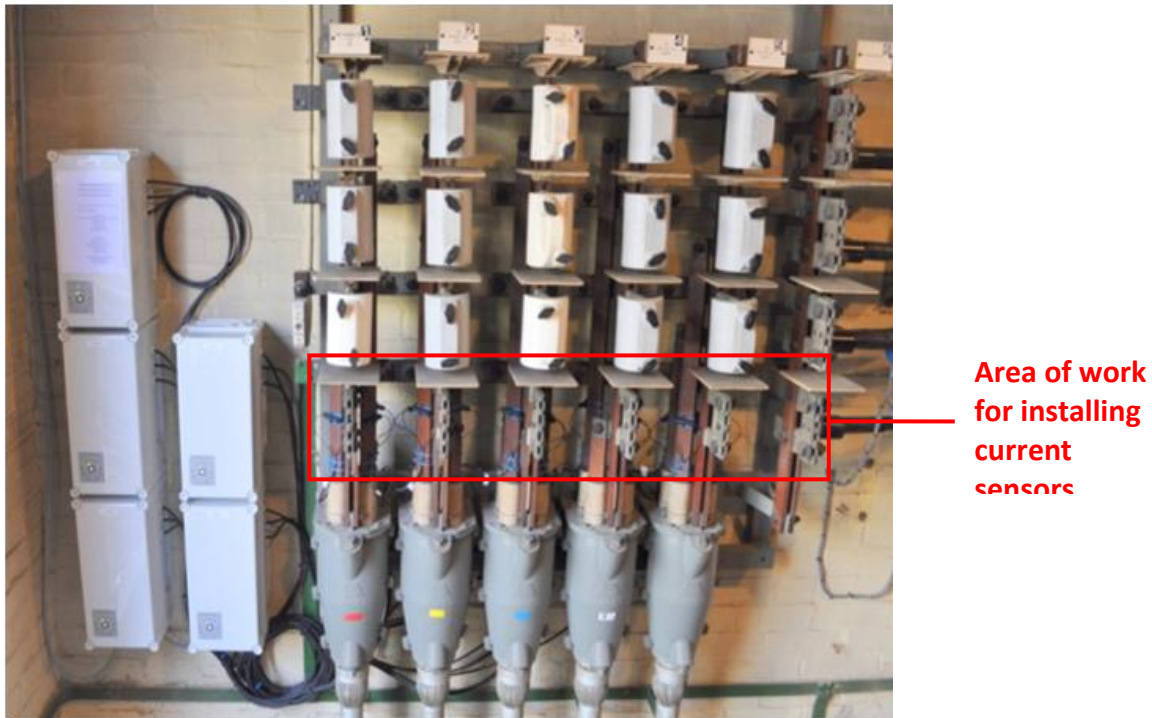

Figure 1: Area of work highlighted for Lucy B1 and B2 type board

Installation and Operation of Monitoring Equipment on LV Distribution Equipment

Document Number: EOS 01-0053

Version: 1.0

Date: 15/11/2012

The Installers shall familiarise themselves with the opening and closing technique of the chosen current sensor prior to attempting live installation.

When preparing the installation method, consideration should be given to the following points:

- Whether there is sufficient access to the cable terminations to allow safe installation to be carried out;
- Whether the separation between the cores is sufficient to allow safe installation of the particular sensor being installed. This assessment will take into account the physical dimensions of the sensor being considered and the physical situation of the cable terminations at the site;
- Live conductors must not be disturbed or manipulated in the process of installing the current sensors. If this cannot be achieved a different current sensor must be considered or the installation must not proceed.

6.2 Voltage Connection

- If 3 phase auxiliary connections are not available, voltage connection will be made using a modified fuse carrier (as detailed in Appendix A) which has a 4mm socket allowing connection to phase voltage of the fuse. The fuse carriers are to be fitted with the 4mm socket at the top to avoid loss of voltage in the event of a fuse operation.
- Replacement of fuse carriers will be carried out by an Authorised Person authorised to carry out LV switching operations and follow the procedures set out for the Region of work.
- Connection of the auxiliary voltage leads shall only be carried out by a person Authorised to Switch on LV Systems or Competent to Install Test/Control Equipment on LV Systems. PPE shall be worn in accordance with DSR 01 019.
- Neutral connection will be made using the existing auxiliary supply connection.

6.3 Signal Cable Management

- Excess cable will be bundled near the communications box rather than the LV Board.
- Cables will be arranged tidily and tied together exiting the LV board in a flexible conduit to the communications box.
- Voltage signal cables from the modified fuse carriers will be tied together with minimal excess in front of the fuse carriers.

Installation and Operation of Monitoring Equipment on LV Distribution Equipment

Document Number: EOS 01-0053

Version: 1.0

Date: 15/11/2012

6.4 Communications Box

The communications box will be installed in an appropriate position using a suitable fixing method as close as possible to the LV Board. See Figure 1.

The position of the box will be chosen based on the layout of the particular site. Regard should be given to the following points:

- Will the cables between the LV board and communications box cause a tripping hazard?
- Will the position of the communications box **restrict** access or egress to any part of the substation?
- Will the position of the box restrict operation of any of the substation equipment?
- Will the position of the box create a hazard to operatives when carrying out any operations (e.g head injury due to poor location)?
- If the communications box is to be installed in an outdoor substation, it will be enclosed in suitably weatherproof housing (IP56) and the signal cables will pass through earth screened flexible conduit between the LV board and the Communications Box.

6.5 Ellipse Asset Registration

Once the installation has been completed, details of the equipment installed will be recorded in Ellipse. This will be done using an asset registration form available from the Intranet Ellipse Reporting pages: Asset Registration, Asset Registration Form, select the Equip Class “Control and Monitoring”.

Please see Appendix B for details of what information to record in the asset registration form.

Depending on which network area the installation is, forms will be sent to the following mailboxes:

- ART.EPN@ukpowernetworks.co.uk
- ART.LPN@ukpowernetworks.co.uk
- ART.SPN@ukpowernetworks.co.uk

7 Operation

Upon completion of the work, a laminated card (see Appendix C) will be placed in a prominent position to give a short description of the operational procedure and contact details. A copy of this document will also be held by the Network Control Centre. The Control Centre will be informed of the installation and a note will be made on the network diagram to mark the installation including a reference to this document.

An Operational Bulletin will be issued to staff in all license areas to provide information about the LV monitoring installations. This bulletin will contain the procedure for operating modified fuse carriers as detailed in section 7.1.

Installation and Operation of Monitoring Equipment on LV Distribution Equipment

Document Number: EOS 01-0053

Version: 1.0

Date: 15/11/2012

7.1 Modified Fuse Carriers

- **Do not operate a modified fuse carrier before removing the 4mm plug.**
- Remove 4mm plug from all three carriers of the circuit before any operations.
- Carry out operations as required.
- Replace 4mm plugs once all work has been completed noting original positions (will be clear from length of signal cables and other identification).
- Connection of the auxiliary voltage leads shall only be carried out by a person Authorised to Switch on LV Systems or Competent to Install Test/Control Equipment on LV Systems. PPE shall be worn in accordance with DSR 01 019.

7.2 Current Sensors

Current sensors installed on LV cables should not affect common operations. Removal of sensors (should it be required) shall only be carried out by a person familiar with the necessary procedure. Information to this effect will be included on the substation information card shown in Appendix C.

8 Decommissioning

Upon completion of the trial period or when the data being gathered is no longer being actively used, the equipment will be removed from substations. Removal of the equipment, in particular the current sensors, shall be carried out by a person familiar with such operations.

All equipment removed shall be returned to the Innovation Team allowing it to be redeployed in support of further activities if required. Upon full decommissioning and removal of the equipment, the Asset Systems team shall be informed so that the equipment status in Ellipse can be updated.

Installation and Operation of Monitoring Equipment on LV Distribution Equipment

Document Number: EOS 01-0053

Version: 1.0

Date: 15/11/2012

Appendix A - Equipment For Use In Trials

Voltage connections

The approved method for making a voltage connection to an LV phase for the purpose of monitoring is to replace the relevant fuse carrier(s) with the modified fuse carrier detailed below. This will provide a fused 4mm connection.

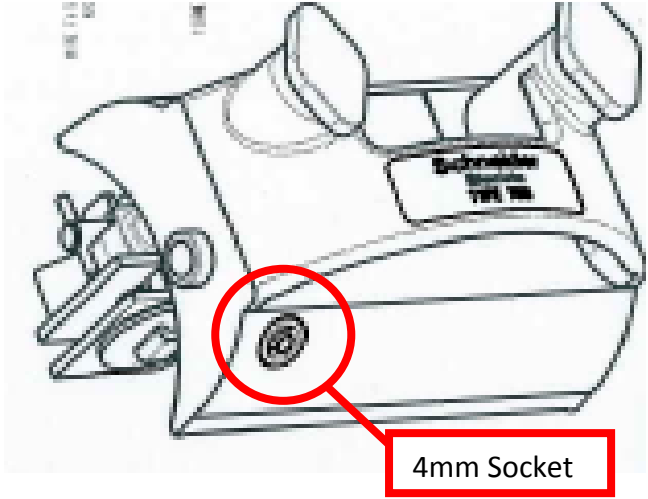
Manufacturer	Model	
Schneider	EEK120	

Installation and Operation of Monitoring Equipment on LV Distribution Equipment

Document Number: EOS 01-0053

Version: 1.0

Date: 15/11/2012

Current Sensors

Manufacturer	Model	
Sentec Ltd for GridKey	GH-600-D-XX	
Technology:- Modified Rogowski Precautions:		
Dimensions (l x w x h) or External and Internal diameters mm	68.4 x 39.2 x 46.7 Designed to fit 300mm Wavecon cable.	
Insulation Type and Level (sensor & leads)	Type B sensor as per BS EN 61010-2-032:2002, Category IV, Pollution degree 3 with surge protection to 5.4kV as defined in BS EN 61010-2-032:2002. Also complies with the relevant sections of BS EN 61010-1: 2001.	
Short Circuit Rating (A)	The sensor is not damaged by currents in excess of 50kA	
Voltage Rating (V)	230V ac	
Operating Temperature (°C)	-20C to +55C (<93% RH, non-condensing).	
Current Measurement Range (A)	Current range of 4A to 600A ac (720A maximum current).	
Sensor Accuracy (over range)	Class 1 metrology accuracy in accordance with IEC 60044-8, with a primary rated current of 600A, extended primary current factor of 1.2 to give a maximum primary current of 720A, at 50Hz.	
Lead Lengths (m)	1.5, 3 and 5m lengths	
Manufacturer Testing	The sensor is HiPot tested to ensure compliance with electrical safety and insulation type and level as defined in the section above. The sensor is also tested for function and metrology accuracy.	
CE Mark	Not separately marked but covered as a system component under the CE marking for the GridKey system.	
Shorting Link (for CT)	N/A	

Installation and Operation of Monitoring Equipment on LV Distribution Equipment

Document Number: EOS 01-0053

Version: 1.0

Date: 15/11/2012

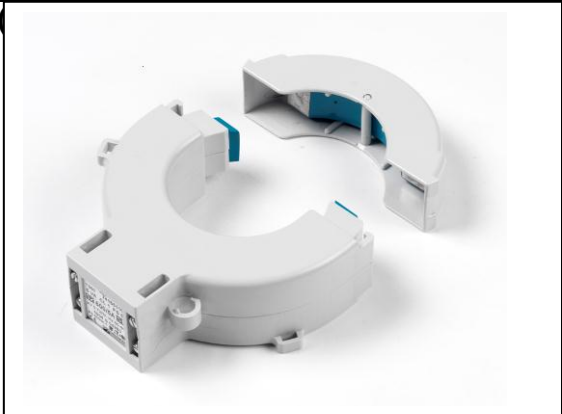
Manufacturer	Model	
Eaton Electric Aps.	741S5110	
<p>Technology:- Split Core measuring Current transformer, ring core wound on one half.</p> <p>Precautions: This sensor is not rated as insulated so shall only be installed on insulated parts of the network.</p>		
Dimensions (l x w x h) or External and Internal diameters mm	99,5mm x 50mm	
Insulation Type and Level (sensor & leads)	Isolation class B (IEC60044-1) Cable: 300/500V, Test Voltage: 2kVac	
Short Circuit Rating (A)	20kA-3s	
Voltage Rating (V)	0.72kV	
Operating Temperature (°C)	50 °C @ 100% In	
Current Measurement Range (A)	600/5A	
Sensor Accuracy (over range)	Cl. 1 FS5 IEC60044-1	
Lead Lengths (m)	5m	
Manufacturer Testing	According to IEC60044-1	
CE Mark	Yes	
Shorting Link (for CT)	Yes	

Installation and Operation of Monitoring Equipment on LV Distribution Equipment

Document Number: EOS 01-0053

Version: 1.0

Date: 15/11/2012

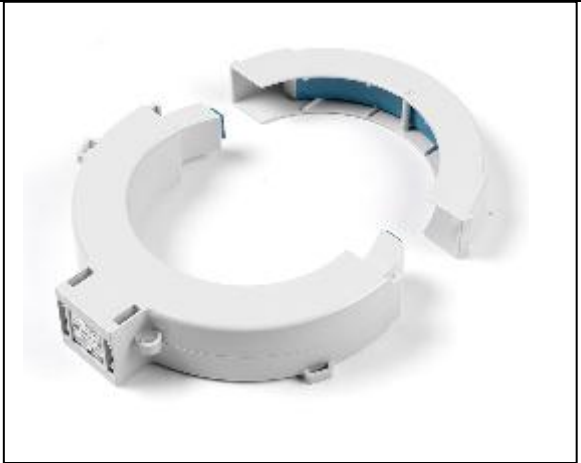
Manufacturer	Model	
Eaton Electric Aps.	741S5212	
<p>Technology:- Split Core measuring Current transformer, ring core wound on one half.</p> <p>Precautions: This sensor is not rated as insulated so shall only be installed on insulated parts of the network.</p>		
Dimensions (l x w x h) or External and Internal diameters mm	153,5mm x 100mm	
Insulation Type and Level (sensor & leads)	Isolation class B (IEC60044-1) Cable: 300/500V, Test Voltage: 2kVac	
Short Circuit Rating (A)	20kA-3s	
Voltage Rating (V)	0.72kV	
Operating Temperature (°C)	50 °C @ 100% In	
Current Measurement Range (A)	800/5A	
Sensor Accuracy (over range)	Cl. 1 FS5 IEC60044-1	
Lead Lengths (m)	5m	
Manufacturer Testing	According to IEC60044-1	
CE Mark	Yes	
Shorting Link (for CT)	Yes	

Installation and Operation of Monitoring Equipment on LV Distribution Equipment

Document Number: EOS 01-0053

Version: 1.0

Date: 15/11/2012

Manufacturer	Model	
J&D	JRF-55	
<p>Technology:- Rogowski</p> <p>Requires the usage of PowerSense IO Rogowski module.</p> <p>Precautions:</p>		
Dimensions (l x w x h) or External and Internal diameters mm	10cm x 1cm x 7cm	
Insulation Type and Level (sensor & leads)	Insulation category II and III (depending on grade) Housing UL94-V0	
Short Circuit Rating (A)	3000A	
Voltage Rating (V)	600VAC	
Operating Temperature (°C)	-20 to +60	
Current Measurement Range (A)	0 to 500A	
Sensor Accuracy (over range)	+/- 5% uncalibrated +/- 1% calibrated	
Lead Lengths (m)	1.5 meters (default)	
Manufacturer Testing	Each rogowski is routine tested at the factory	
CE Mark	Yes	
Shorting Link (for CT)	N/A	

Installation and Operation of Monitoring Equipment on LV Distribution Equipment

Document Number: EOS 01-0053

Version: 1.0

Date: 15/11/2012

Manufacturer	Model	
PowerSense	DISCOS Indoor Current Sensor	
<p>Technology:- Faraday, optical technology</p> <p>Requires the usage of PowerSense OPTI module</p> <p>Precautions:</p>		
Dimensions (l x w x h) or External and Internal diameters mm	15cm x 1cm x 10cm (the part illustrated in the picture)	
Insulation Type and Level (sensor & leads)	The sensor is made of non noconductive parts	
Short Circuit Rating (A)	20.000A	
Voltage Rating (V)	Up to 36kV	
Operating Temperature (°C)	-20 to +80	
Current Measurement Range (A)	5A to 20.000A	
Sensor Accuracy (over range)	5-100A (+/- 2A) 100A-20.000A (+/- 2%)	
Lead Lengths (m)	Up to 16 meters (normally 2-4m)	
Manufacturer Testing	Each sensor is tested during production (routine test)	
CE Mark	N/A	
Shorting Link (for CT)	N/A	

Installation and Operation of Monitoring Equipment on LV Distribution Equipment

Document Number: EOS 01-0053

Version: 1.0

Date: 15/11/2012

Manufacturer	Model	
Current	9650, 9651	
Technology: Rogowski coil (flexible) Precautions:		
Dimensions (l x w x h) or External and Internal diameters mm	Internal diameter: 130 mm for 9650, 190 mm for 9651 Coil diameter: 16 mm	
Insulation Type and Level (sensor & leads)	600Vrms category IV or 1000Vrms category III in accordance with IEC 61010-2-32.	
Short Circuit Rating (A)	This is not strictly applicable to the sensor by itself. However, Current's LVA, when used with this sensor, is rated to 30kA.	
Voltage Rating (V)	This is not applicable to the sensor by itself. However, Current's LVA has an effective range from 0 to 350Vrms.	
Operating Temperature (°C)	-40°C to +85°C.	
Current Measurement Range (A)	This is not strictly applicable to the sensor by itself. However, Current's LVA, when used with this sensor, has an effective range from 0 to 2400A.	
Sensor Accuracy (over range)	The sensor by itself is accurate within +/- 5% regardless of the position and orientation of the threading conductor and regardless of the proximity of other (non-threading) conductors. Current's LVA, when used with this sensor, has the following accuracy: <ul style="list-style-type: none"> • 0 to 1A: +/-6% • 1 to 20A: +/-3% • 20 to 2400A: +/-1.5% Note: the error is relative to the reading, not full scale as some other products specify.	
Lead Lengths (m)	3 meters. A 10 meter extension cable is available from Current.	
Manufacturer Testing	Each sensor is factory tested and calibrated using a proprietary multipoint calibration technique.	
CE Mark	Yes.	
Shorting Link (for CT)	Not applicable.	

Installation and Operation of Monitoring Equipment on LV Distribution Equipment

Document Number: EOS 01-0053

Version: 1.0

Date: 15/11/2012

Manufacturer	Model	
Current	9660	
Technology: Rogowski coil (rigid, disjoint)		
Precautions: Not currently rated for use on bare conductors. Bare conductors must be insulated appropriately as part of the installation of these sensors.		
Dimensions (l x w x h) or External and Internal diameters mm	External diameter: 92 mm for 9603, 155 mm for 9604 Internal diameter: 45 mm for 9603, 110 mm for 9604 Length: 48 mm	
Insulation Type and Level (sensor & leads)	This sensor is not currently rated in accordance with IEC 61010-2-32. Once certified, it will be rated for use on bare conductors and the special requirement noted above will be removed.	
Short Circuit Rating (A)	This is not strictly applicable to the sensor by itself. However, Current's LVA, when used with this sensor, is rated to 30kA.	
Voltage Rating (V)	This is not applicable to the sensor by itself. However, Current's LVA has an effective range from 0 to 350Vrms.	
Operating Temperature (°C)	-40°C to +85°C.	
Current Measurement Range (A)	This is not strictly applicable to the sensor by itself. However, Current's LVA, when used with this sensor, has an effective range from 0 to 2400A.	
Sensor Accuracy (over range)	The sensor by itself is accurate within +/- 1% regardless of the position and orientation of the threading conductor and regardless of the proximity of other (non-threading) conductors. Current's LVA, when used with this sensor, has the following accuracy: <ul style="list-style-type: none"> • 0 to 1A: +/-6% • 1 to 20A: +/-3% • 20 to 2400A: +/-1% Note: the error is relative to the reading, not full scale as some other products specify.	
Lead Lengths (m)	3 meters. A 10 meter extension cable is available from Current.	
Manufacturer Testing	Each sensor is factory tested and calibrated using a proprietary multipoint calibration technique.	
CE Mark	Not at this time.	
Shorting Link (for CT)	Not applicable.	

Installation and Operation of Monitoring Equipment on LV Distribution Equipment

Document Number: EOS 01-0053

Version: 1.0

Date: 15/11/2012

Manufacturer	Model	
Current	9603, 9604	
Technology: Rogowski coil (rigid, hinged) Precautions: Not for use on bare conductors. Bare conductors must be insulated appropriately as part of the installation of these sensors.		
Dimensions (l x w x h) or External and Internal diameters mm	External diameter: 92 mm for 9603, 155 mm for 9604 Internal diameter: 45 mm for 9603, 110 mm for 9604 Length: 48 mm	
Insulation Type and Level (sensor & leads)	This sensor is not currently rated in accordance with IEC 61010-2-32.	
Short Circuit Rating (A)	This is not strictly applicable to the sensor by itself. However, Current's LVA, when used with this sensor, is rated to 30kA.	
Voltage Rating (V)	This is not applicable to the sensor by itself. However, Current's LVA has an effective range from 0 to 350Vrms.	
Operating Temperature (°C)	-40°C to +85°C.	
Current Measurement Range (A)	This is not strictly applicable to the sensor by itself. However, Current's LVA, when used with this sensor, has an effective range from 0 to 2400A.	
Sensor Accuracy (over range)	The sensor by itself is accurate within +/- 1% regardless of the position and orientation of the threading conductor and regardless of the proximity of other (non-threading) conductors. Current's LVA, when used with this sensor, has the following accuracy: <ul style="list-style-type: none"> • 0 to 1A: +/-6% • 1 to 20A: +/-3% • 20 to 2400A: +/-1.5% Note: the error is relative to the reading, not full scale as some other products specify.	
Lead Lengths (m)	3 meters. A 10 meter extension cable is available from Current.	
Manufacturer Testing	Each sensor is factory tested and calibrated using a proprietary multipoint calibration technique.	
CE Mark	Not at this time.	
Shorting Link (for CT)	Not applicable.	

Installation and Operation of Monitoring Equipment on LV Distribution Equipment

Document Number: EOS 01-0053

Version: 1.0

Date: 15/11/2012

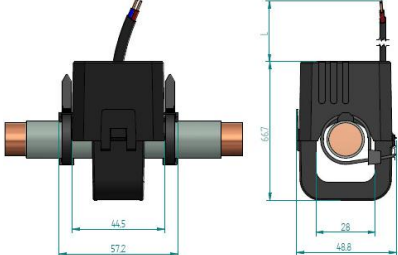
Manufacturer	Model	
ELEQ	TQ40-4Q4C13	
Technology:- CT Split-Core Precautions: This sensor is not rated as insulated so shall only be installed on insulated parts of the network.		
Dimensions (l x w x h) or External and Internal diameters mm		
Insulation Type and Level (sensor & leads)	Insulation Class = E (max120°)	
Short Circuit Rating (A)	The sensors are tested for 30kA / 1s. 50kA / 1s is not perceived as a problem when considering the way the sensor is connected to the SASensor system.	
Voltage Rating (V)	600Vac	
Operating Temperature (°C)	-5...+55°C	
Current Measurement Range (A)	0..500A	
Sensor Accuracy (over range)	Accuracy conform IEC 60044-1, between 5-120% In System accuracy 0,5S class	
Lead Lengths (m)	0,5m	
Manufacturer Testing	Conform IEC60044-1	
CE Mark	Yes	
Shorting Link (for CT)	Yes	

Installation and Operation of Monitoring Equipment on LV Distribution Equipment

Document Number: EOS 01-0053

Version: 1.0

Date: 15/11/2012

Manufacturer	Model	
HAYSYS Ltd	H00168-000	
Technology:- Rogowski Coil Precautions:		
Dimensions (l x w x h) or External and Internal diameters mm	Loop Diameter – 500mm Coil Diameter – 10mm	
Insulation Type and Level (sensor & leads)	Coils are insulated in a single or double layer of polyolefin sleeve (UL E35586, AMS-DTL-23053/4 Class 3). The outer layer is black with a yellow inner layer.	
Short Circuit Rating (A)	Not Applicable	
Voltage Rating (V)	7kV A.C.	
Operating Temperature (°C)	Up to 80°C	
Current Measurement Range (A)	1mA to 1MA. However the SMC is limited to a maximum output of 2,500A	
Sensor Accuracy (over range)	Calibration accuracy of <1% Linearity error of <0.1%	
Lead Lengths (m)	Currently supplied 2m but longer lengths available up to 100m	
Manufacturer Testing	SMC tested in accordance with Test Specification TS00005.	
CE Mark	SMC including sensors are compliant with the CE directive	
Shorting Link (for CT)	Not Applicable	

Installation and Operation of Monitoring Equipment on LV Distribution Equipment

Document Number: EOS 01-0053

Version: 1.0

Date: 15/11/2012

Manufacturer	Model	
GMC-I PROSyS Ltd	TDM 504	
Technology:- Total demand monitor based on a Rogowski Coil Sensor Precautions:		
Dimensions (l x w x h) or External and Internal diameters mm	Rogowski Sensor 6mm sensor cable diameter with 75mm diameter and 2m output cable. System Housing: L 600 x D 300 x H 210	
Insulation Type and Level (sensor & leads)	1000V Cat III or 600V Cat IV Pollution Degree 2	
Short Circuit Rating (A)	Not Applicable but limited to Overloads of 40kA	
Voltage Rating (V)	Voltage Input 450V – Line to Line	
Operating Temperature (°C)	-20 to +70°C	
Current Measurement Range (A)	500A rms	
Sensor Accuracy (over range)	1% of reading	
Lead Lengths (m)	2m from Sensor head to System Housing	
Manufacturer Testing	100% Dielectric Testing of Sensors. 100% Performance Tested against specification	
CE Mark	Yes	
Shorting Link (for CT)	Not applicable	

Installation and Operation of Monitoring Equipment on LV Distribution Equipment

Document Number: EOS 01-0053

Version: 1.0

Date: 15/11/2012

Manufacturer	Model	
Ambient Corporation	CTS-1250	
Technology:- Split core, burden resistor included Precautions:		
Dimensions (l x w x h) or External and Internal diameters mm	External: 85.1 x 82.5 x 26.2; internal opening 31.5 x 31.75	
Insulation Type and Level (sensor & leads)	Sensor: Epoxy Leads: PVC (0.15 meter), Polyethylene (2.8 meters)	
Short Circuit Rating (A)	Not applicable (burden resistor internal)	
Voltage Rating (V)	600 VAC	
Operating Temperature (°C)	-10 to 55	
Current Measurement Range (A)	60 A to 780 A	
Sensor Accuracy (over range)	± 1%	
Lead Lengths (m)	2.8	
Manufacturer Testing	<ul style="list-style-type: none"> • UL and cUL Safety Listed: UL 61010-1; CAN/CSA-C22.2. No. 61010-1-04; IEC 61010-1 • Immunity: EN 61326:2002 • Electrostatic Discharge: EN51000-4-2: (B) Self-recovering • Radiated RF Immunity: EN51000-4-3: (A) No degradation • Electrical Fast Transient/Burst: EN61000-4-4: (B) Self-recovering • Surge Immunity: EN 61000-4-5: (B) Self-recovering • Conducted RF Immunity: EN 61000-4-6: (A) No degradation • Voltage Dips and Interrupts: EN 61000-4-11: (B) Self-recovering • Emissions: FCC Part 15, Class B; EN 55022: 1994, Class B 	
CE Mark	yes	
Shorting Link (for CT)	Not required – low voltage output when energized	

Installation and Operation of Monitoring Equipment on LV Distribution Equipment

Document Number: EOS 01-0053

Version: 1.0

Date: 15/11/2012

Manufacturer	Model	
GMC-I PROSyS Ltd	ACP 1003_4 and ACP 1003_5	
Technology:- Total demand monitor based on a Rogowski Coil Sensor Precautions:		
Dimensions (l x w x h) or External and Internal diameters mm	Rogowski Sensor 6mm sensor cable diameter with 100mm diameter and 4m output cable. System Housing: L 600 x D 300 x H 210	
Insulation Type and Level (sensor & leads)	1000V Cat III or 600V Cat IV Pollution Degree 2	
Short Circuit Rating (A)	Not Applicable but limited to Overloads of 40kA	
Voltage Rating (V)	Voltage Input 450V – Line to Line	
Operating Temperature (°C)	-20 to +65°C	
Current Measurement Range (A)	1000A rms	
Sensor Accuracy (over range)	1% of reading	
Lead Lengths (m)	4m from Sensor head to System Housing	
Manufacturer Testing	100% Dielectric Testing of Sensors. 100% Performance Tested against specification	
CE Mark	Yes	
Shorting Link (for CT)	Not applicable	

**Installation and Operation of Monitoring Equipment on LV
Distribution Equipment**

Document Number: EOS 01-0053

Version: 1.0

Date: 15/11/2012

Appendix B - Asset Registration Information

Asset Information	Mandatory To Record (Y/N)	Comments
Equipment GRP ID (EGI)	Yes	This is preassigned in the form as Control and Monitoring Equipment.
Manufacturer	Yes	
Model of Equipment	Yes	
Serial Number	Yes	
Year of Manufacturer	Yes	
Location	Yes	This is a number.
District Code	Yes	This is a number which shows whether equipment in LPN/EPN/SPN.
Area	Yes	Under field Equip_Classification 5
Equipment Type	Yes	Under field Equip_Classification 4
Equipment Status	Yes	Commissioned or decommissioned.
Parent Equipment	Yes	This will be the Distribution Board that holds the electronics and power supply.
Item Name 1	No	This will be "Monitoring Equipment <S/S No> <Unit No if more than one installed at site>".
Item Name 2	No	This will be the Substation Name.
Indoor or Outdoor	No	Under field Equip_Classification 2
Custodian	No	Is the equipment owned by a private customer or the DNO.

Appendix C - Example Operational Instruction Card

Read Before Operating Fuses

- This substation has been fitted with LV monitoring equipment.
- One LV way may have been fitted with fuse carriers that provide an auxiliary voltage connection.
- Before operating these fuses the auxiliary voltage connections must first be removed.
- Once all operations are completed the connections should be replaced in their original order.
- The plugs and sockets have coloured tags to indicate correct connections.
- **Connection of the auxiliary voltage leads shall only be carried out by a person Authorised to Switch on LV Systems or Competent to Install Test/Control Equipment on LV Systems. PPE shall be worn in accordance with DSR 01 019.**
- Current sensors should not create operational issues. These should only be removed by a person familiar with the removal procedure.
- If for any reason you feel the installation is preventing operation or presenting a hazard please contact Control.
- A full Engineering Operation Standard for this installation is available on the



Fuse Carrier with red
Auxiliary voltage plugs



Current Sensors

Appendix D – Project Change Mandates



WPD Future Networks Programme Change Mandate

Project Number		WPDT1006	Change Number		1
Originator: Steven Burns			Tel: 01332827445		Date: 1/9/2012
Project Manager: Steven Burns			Project: LV Sensor Evaluation		
Change Title: Field Trial Duration					
Change Type:					
Resource			New Requirement		
Change in Scope		X	Budget Change		
Milestone Change		X			
Other dependent projects affected: None					
Proposed change: Reduce the duration of number of field trials from 12 months to 10 months					
Reason for change: Delays in equipment delivery and installations					
Effect of NOT making change: Project would be delayed and would have to be extended. Output learning would then be delayed.					
Impacts of Change:					
Milestones		X	Deliverables		
Resources			Project End Date		
Costs			Benefits		
Project Scope		X	Learning Outcomes		
Describe the impacts on the project for the categories above : Milestones – Delay to the installation of a number of substation monitors Project Scope – Project called for 12 month field trial. This will be possible with some of the installations, but will be reduced to 10 months for a number of sites.					
Cost of making the change (and justification): £0 – No cost to making the change. Justification based on not delaying project learning outputs. It is considered that this will not have a significant effect on the learning from the project.					
Supporting Information: The original 12 month period was suggested to allow a whole year of data to be gathered, while operating the units for a year to test reliability. It is considered that reducing the trial to 10 months will not greatly affect the overall outcome as it is expected that most failures would occur in the first few months. In addition a years worth of monitoring data is not critical to the project outcomes.					
Signed:					Date :
Project Manager 					1 st Sep 2012
Future Networks Manager 					1/9/12
Project Sponsor					

WPD Future Networks Programme Change Mandate

<i>Project Number</i> WPDT1006		<i>Change Number</i> 2	
Originator: Steven Burns		Tel: 01332827445	Date: 10/9/2012
Project Manager: Steven Burns		Project: LV Sensor Evaluation	
Change Title: Sensor Change			
Change Type:			
Resource		New Requirement X	
Change in Scope		Budget Change	
Milestone Change			
Other dependent projects affected: None			
Proposed change: Change of LV sensor to be installed with Locamation equipment			
Reason for change: The original proposal from Locamation featured sensors that were difficult to install and posed a potential safety risk due to exposed metal work and parts detaching.			
Effect of NOT making change: Locamation equipment would be removed from the trial			
Impacts of Change:			
Milestones		Deliverables X	
Resources		Project End Date	
Costs		Benefits	
Project Scope		Learning Outcomes	
Describe the impacts on the project for the categories above : Alternative equipment to be installed than was initially procured for.			
Cost of making the change (and justification): £0 – No cost to making the change. Justification based on ensuring that seven monitoring solutions are trial rather than 6.			
Supporting Information:			
Signed: Project Manager 		Date : 10th Sep 2012	
Future Networks Manager 		10/9/12	
Project Sponsor			