



A framework for the evaluation of smart grids

A CONSULTATION DOCUMENT PREPARED FOR OFGEM

November 2011

A framework for the evaluation of smart grids

Executive Summary	1
<i>Key challenges</i>	1
<i>Approach</i>	3
<i>Proposed model specification</i>	6
<i>Questions for consultation</i>	7
Summary of consultation questions	8
1 Introduction	11
1.1 <i>Objectives of this project</i>	12
1.2 <i>Work plan for this project</i>	12
1.3 <i>Objectives of this report</i>	13
2 Smart grid evaluation framework	15
2.1 <i>What do we mean by a “smart grid”?</i>	15
2.2 <i>Key questions for evaluation framework</i>	17
2.3 <i>Overview of evaluation framework</i>	18
3 Value drivers and scenarios	33
3.1 <i>Smart grid value drivers</i>	33
3.2 <i>Scenarios</i>	65
4 Smart grid and conventional investment strategies	69
4.1 <i>Business-as-usual investment scenario</i>	70
4.2 <i>Smart grid investment strategies</i>	76
5 Value chain analysis	93
5.1 <i>Distribution of smart grid investment costs</i>	94
5.2 <i>Distribution of smart grid benefits</i>	94
6 Proposed model specification	103
6.1 <i>Structure of the model</i>	104
6.2 <i>Real options CBA model</i>	106

6.3	<i>Distribution network model</i>	107
6.4	<i>Modelling the wider electricity sector</i>	124
6.5	<i>Demand profiles</i>	130
7	Annexe A – literature review	139
7.1	<i>Technologies involved in the smart grid</i>	142
7.2	<i>Costs and benefits arising from a smart grid</i>	144
7.3	<i>Smart grid value drivers</i>	145
7.4	<i>Modelling of demand-side response</i>	146
7.5	<i>Bibliography</i>	148

A framework for the evaluation of smart grids

Figure 1. Schematic overview of proposed framework for evaluating smart grid value	19
Figure 2. Overview of proposed approach	23
Figure 3. Smart grid investment strategies	24
Figure 4. Investment profiles and lead times	26
Figure 5. Real options based approach	29
Figure 6. Typical domestic heat pump profile with stylised storage element	40
Figure 7. Estimated commercial heat pump profile	40
Figure 8. Estimated charge profile - residential	43
Figure 9. Daily profiles of a 2.8kW PV installation in June	50
Figure 10. Power output variation for seven April days (Single-site)	53
Figure 11. Van der Hoven frequency spectrum of wind speed variation	56
Figure 12. Energy sector challenges and smart grid value drivers	62
Figure 13. Stylised illustration of how lower peak transmission load flows could defer network reinforcement	98
Figure 14. Model overview	105
Figure 15. Illustrative output table	107
Figure 16. Structure of distribution network parametric model	109
Figure 17. Schematic diagram of the network model	111
Figure 18. Network modelling engine	113
Figure 19. Scenario characterisation	118
Figure 20. Illustration of network investments	119
Figure 21. Solution set model	122
Figure 22. Network model outputs	123

Figure 23. Generation Wider electricity sector model overview	125
Figure 24. Overview of model interlinkages for DSR	133
Figure 25. Feedback effects	136
Table 1. Summary of the impact of heat and transport electrification	46
Table 2. Value-driving technologies that we propose to include in our evaluation framework	64
Table 3. Importance and uncertainty over value drivers	66
Table 4. Smart meter functionality	75
Table 5. Conditions under which different strategies might be preferable	77
Table 6. Smart grid solution sets	78
Table 7. Summary of functionalities provided by key smart grid technologies	83
Table 8. The parametric model structure	112
Table 9. LCT clustering, based upon FiT data	117
Table 10. Priority stack illustration for a single investment strategy (the solution stacks illustrated are for the three representative LV networks, and the single representative 11kV and 33kV networks).	121
Table 11. Demand profiles used within the model	131
Table 12. Comparison of the ENSG and EPRI CBAs	140

Executive Summary

Ofgem has appointed Frontier and EA Technology to develop a framework that will allow smart grid investment opportunities to be evaluated. This report sets out our proposed methodology for developing this framework for consultation.

We aim to help Ofgem and the industry reach a better understanding of:

- the drivers of the value of smart grids;
- the value of the flexibility smart grids may provide under conditions of uncertainty; and
- the parties in the value chain that will benefit from smart grid solutions.

Our analysis will have the following scope:

- we will focus on the impact of smart grid investments at distribution network level;
- we will seek to identify the spread of costs and benefits across the electricity sector, as well as the net benefits to society as a whole; and
- we will take a long-term view and assess the impacts of smart grid investments out to 2050, although our focus will be on drawing out the implications for the near term.

It is recognised that a framework for evaluating the net benefits of smart grid solutions is important if Distribution Network Operators (DNOs) are to justify smart grid investments, when the benefits of such investments are less certain than for more conventional solutions.

This report sets out our proposed methodology for developing the framework for consultation. Following this consultation, we will formalise the evaluation framework in a simple and transparent model. This model will be available in the public domain and will allow users to assess how the net benefits of smart grid technologies might change with different developments in the electricity sector.

Key challenges

Developing a smart grid evaluation framework is a challenging task since it must address a number of important complexities.

Smart grids as enabling technologies

A smart grid may help meet high level decarbonisation and security of supply goals. However, these goals can generally also be achieved through traditional reinforcement.

Our evaluation will therefore focus on smart grids as a means to achieving decarbonisation and security of supply objectives, rather than evaluating decarbonisation and security of supply as ends in themselves.

In practice this means we will hold objectives such as overall emissions and supply reliability constant, and will compare the costs and benefits associated with different ways of achieving these outcomes. However, where the application of different solutions leads to changes in security of supply or carbon emissions as ancillary benefits, we will include these in our evaluation.

Multiple solutions

A smart grid is not one technology. There are multiple solutions available in different combinations and for different circumstances. While solving for the 'optimal' mix of smart grid technologies is beyond the scope of this project, our evaluation framework must pay close attention to the potential interactions between technologies.

We therefore propose to assess the costs and benefits of representative smart grid investment packages or strategies, rather than assessing individual technologies in isolation.

Scale and profile of investment required

The relationship between the costs and benefits of smart grids and the scale and profile of investment may be complex. Solutions may differ in the following ways:

- the extent to which they need to be applied in a coordinated fashion to be effective;
- the extent to which they involve up-front capital investment and the subsequent lifespan of these assets; and
- the speed with which they can be deployed.

To take account of these differences, we intend to assess two smart grid investment strategies, one based around a top-down or holistic implementation of a smart grid, and the other based around a more incremental, reactive rollout.

Uncertainty and option value

There is a large degree of uncertainty over future demand and supply conditions in the electricity sector to 2050. Our evaluation needs to not only help us understand which technology performs best under a given future scenario, but also help us understand which technology is likely to be most desirable given this uncertainty over future scenarios. In practice, this means our evaluation framework must:

Executive Summary

- consider more than one possible scenario; and
- take account of the “option value” that arises from networks being able to modify their investment strategies in future years in response to new information about the value of smart grids.

To capture these uncertainties, we propose to consider three scenarios which represent alternative potential developments in the electricity sector to 2050, and to employ a real-options based approach in our evaluation framework. Our real-options based approach will take the form of a two-stage decision tree and will allow the best strategy to be chosen in the face of uncertainty, by factoring in:

- the impact of new information on the state of the world at a decision point in the future; and
- the extent to which the investment strategy today facilitates or limits the ability of networks to adjust their investment strategies when this new information becomes available.

Uncertainty over the quantity and value of Demand Side Response (DSR)

Some smart grid technologies will help facilitate DSR. Assessing the value of this service is likely to be an important part of an assessment of the value of smart grids. However, there is uncertainty over how responsive customers will be to signals of various kinds, and there are a number of competing uses of DSR (notably demand-shifting by suppliers to reduce wholesale energy costs), which will have different values under different conditions. Our evaluation framework will take account of both supplier-led and DNO-led DSR, as well as alternative sources of flexibility such as pumped storage and OCGT.

In this evaluation, we do not attempt to provide a bottom-up estimate of the proportion of demand that can be shifted. Instead, simple assumptions regarding the responsiveness of demand will form an input to the model. These will be fully flexible to be changed by users of the model.

Approach

We approach the development of our framework in the following way.

- First, we set out our assessment of the factors likely to drive the value of smart grids. Varying the level of these factors then forms the basis of our scenario development.
- Second, we identify the “conventional” and “smart grid” technologies which could be deployed in response to these challenges, and we set out our

approach to defining the deployment strategies that we will evaluate in our model.

- Third, we set out how we propose to disaggregate costs and benefits across the value chain.

Value drivers and scenarios

Our evaluation framework must include the main factors that are likely to affect the net benefits that smart grids could provide. Where there is significant uncertainty over these factors, they need to be varied across scenarios.

Our value driver analysis suggests that the following developments are the most important.

- **The electrification of heat and transport.** The change in the level and profile of demand associated with the electrification of heat and transport will pose a range of challenges for networks. This electrification may also increase the amount of demand available for DSR. We will therefore assess the impact of electric vehicles, plug in hybrids, vehicle to grid technology, heat pumps and heat pumps with storage in our evaluation framework.
- **The increase in distributed generation.** The increase in generation connected to the distribution network will raise network challenges. We will therefore assess the impact of solar PV, small scale wind, and large-scale distribution network connected wind and biomass.
- **The increase in intermittent and inflexible generation.** Changes in the large-scale generation mix are likely to increase the role for DSR. Where this DSR aims to follow the pattern of large-scale intermittent generation, it may increase peaks on distribution networks. Our framework will therefore include assessment of changes in the generation mix.

While the **ongoing drive for network efficiency** is likely to also be a very important value driver for smart grids, there is little uncertainty over its future importance. We therefore do not intend to vary its levels across scenarios.

To take account of future uncertainty, we intend to assess smart grid investment strategies against up to three scenarios, each of which will represent a different state of the world to 2050. These scenarios will be consistent with meeting the UK's fourth carbon budget and will be based on the outputs of workstream 1 of the Smart Grids Forum (SGF).

While it will be possible for the user to vary the numbers associated with each value driver in our model (e.g. the numbers of electric vehicles or heat pumps), adding new value drivers would require amendments to the model.

Executive Summary

Definition of investment strategies

Our evaluation framework will assess two smart grid investment strategies. These will be compared to a business-as-usual strategy. Each strategy will maintain current levels of security of supply and facilitate the same amount of connections of low-carbon plant and demand side technologies. The strategies will differ solely in terms of how they deliver these outcomes.

- **Business-as-usual strategy:** This strategy assumes that smart meters are rolled out as currently planned, but that all additional investment is based on conventional solutions. The assumption we make on smart meter functionality in the business-as-usual case, in particular on the types of DSR that are possible with smart meters alone, is crucial to this analysis. We have set out a range of options for these assumptions in this consultation.
- **Smart grid strategies:** We intend to assess two smart grid strategies. In one strategy, the smart grid will be deployed in a “top-down” manner. In the other, it will be deployed incrementally on a more reactive basis.

Workstream 3 (WS3) of the SGF is currently undertaking a detailed assessment of smart grid technologies. Our evaluation will not duplicate that work. Instead we will analyse a set of representative smart solutions at this stage, and include placeholders in our model for each of the technology types currently being assessed by WS3. These representative technologies are:

- battery electrical energy storage (e.g; flow-cell, Li-Ion, Sodium Sulphur);
- dynamic thermal ratings;
 - overhead lines;
 - underground cables;
 - transformers;
- enhanced automatic voltage control; and
- technologies to facilitate DNO- led DSR.

Our model will allow user flexibility over some of the characteristics of smart grid technologies (such as the base year costs and the impact on headroom of each smart technology). In addition, the set of technologies to be included in the model will be expanded once WS3 reports. However, the “strategy” based approach, and our definition of business-as-usual (including some of our assumptions on smart meter functionality) will be fixed.

Value chain analysis

Our evaluation framework will take account of how the costs and benefits of smart grids are distributed across different parties in the electricity sector.

Our assessment of how these will be spread is as follows:

- **Costs:** The smart grid investments we are assessing relate to technologies and practices that would be rolled out across the electricity distribution networks. This means that, in the absence of any direct public subsidy for such technologies and practices, the costs associated with their introduction would be directly borne by DNOs.
- **Benefits:**
 - **DNOs** The services provided by smart grids should allow DNOs to avoid or defer reinforcement, and could thereby directly reduce their costs.
 - **Transmission network:** DSR facilitated by smart grids could help defer the long-run need for transmission network reinforcement, and thus reduce transmission costs.
 - **Generators and suppliers:** The assumptions we make on the extent to which DSR can be facilitated by smart meters alone will determine the impact of smart grids on generators and suppliers. Assuming that dynamic supplier-led DSR is possible with smart meters alone, smart grids could increase costs to generators and suppliers by shifting demand patterns.
 - **Customers:** Wherever smart grid investments reduce the overall costs of providing electricity to customers, customers should benefit through lower bills.

Proposed model specification

We will aim to represent our evaluation framework in a simple and transparent model, with the objective of increasing the understanding of the broad factors that could affect the value of smart grid investments.

To do this, the model must be transparent enough to enable users to see what is driving the results, and observe the impact of adjusting key assumptions. The model we propose, while still complex, aims to focus on the most important aspects of the evidence framework.

Our model will consist of the following parts:

- **Distribution network model:** The distribution network model assesses the costs of upgrading the distribution networks to accommodate changes on the supply and demand side. The model aims to represent a typical distribution network, taking a parametric, probabilistic approach and considering a variety of representative feeder types. It will determine the

Executive Summary

investments required by DNOs to ensure that all feeders are capable of meeting peak demand and accommodating distributed generation.

- **Wider electricity sector model:** The wider electricity sector model will calculate the cost, and the emissions implications, of meeting demand over the course of each year (including ensuring the system can be balanced and that there is sufficient capacity on the transmission network).
- **Real options CBA model:** The real options CBA model will combine the outputs of these models to calculate net present values and option values for each of the investment strategies.

The model will be placed in the public domain and will allow users to test the impact of changing key assumptions around the future state of the world, such as the number of low-carbon technologies deployed, or the cost of smart grid technologies.

Questions for consultation

We welcome comments in particular on:

- our overall real options-based evaluation framework;
- our assessment of the value drivers of smart grids;
- the assumptions on smart meter functionality;
- the smart grid strategies we intend to assess;
- our approach to including smart technologies in the model; and
- the detailed model specification.

A detailed list of questions is set out at start of this report.

The consultation period will run until December 16th 2011. Responses should be sent to lia.santis@ofgem.gov.uk.

Summary of consultation questions

Section 2: Smart grid evaluation framework?

- Do you agree with our definition of smart grids?
- Have we captured the main complexities associated with assessing the costs and benefits of smart grids?
- Do you agree with our approach to dealing with these complexities, in the overall evaluation framework, in particular:
 - We propose to take a two-stage decision tree approach, rather than relying on a conventional cost-benefit analysis framework alone. Does this constitute an appropriate approach, given the need to measure differences in the “option value” that different smart grid investment strategies provide?
 - Do you agree that the year 2023 constitutes an appropriate decision point in our analysis?

Section 3: Value drivers and scenarios

- Do the technologies set out in Table 2 constitute a sensible list of value drivers?
- Do you agree with our assessment of the technical characteristics of each?
- Are there any other technologies that could have a significant impact on the value of smart grids?
- Our analysis suggests that the most important factors to vary across the scenarios will be:
 - the pace of electrification of heat and transport;
 - the increase in distributed generation; and
 - the increase in intermittent and inflexible generation.
- Do you agree? Are there any other variables that we should look to vary across the scenarios and why?

Section 4: Smart grid and conventional investment strategies

- Out of the options presented, which set of assumptions should we make on smart meter functionality?
- Do you agree with our proposed approach of including smart appliances in the business as usual?
- Do our proposed smart grid strategies capture the main deployment options?
- Have we provided an accurate overview of the main services that smart grid technologies can provide?
- Do you agree with our proposed assumptions on the characteristics of these technologies?

Section 5: Value chain analysis

- Are there any other groups in society that we should consider in the value chain analysis?
- Do you agree with our conclusions regarding the distribution of costs and benefits?
- Do you agree with our proposed approach to assessing the costs and benefits for the transmission network?

Section 6: Proposed model specification

- How suitable is the proposed network modelling methodology which use representative networks, with headroom used to model when network investments should be made on feeders?
- Are the voltage levels (from 132kV down to LV) being considered by the model appropriate, or should the model be limited to focus on any particular voltage levels?
- For each of the voltage levels we are considering, are current methods sufficient to recognise available headroom and the cost of releasing additional headroom in these networks? If not, is the proposed approach considered to be too simple or overly complex?
- Is our approach to estimating the clustering of low-carbon technologies appropriate? Is any other evidence available in this area?

Summary of consultation questions

- Are the proposed generation model assumptions (a simple stack of generator types, no technical dispatch constraints, half-hourly demand profiles for summer and winter, and representative wind profiles) suitable?
- Should a simple representation of interconnection be included in the model?
- Does the model represent demand side response appropriately?

1 Introduction

Ofgem has appointed Frontier and EA Technology to develop a framework that will allow smart grid investment opportunities to be evaluated.

The aim of this work is to develop a practical evaluation framework which can help increase understanding of the likely value of smart grids under different scenarios, and which can be updated and populated with new assumptions as new information arises. This report sets out for consultation our proposed methodology for developing this framework.

This work has been commissioned to feed into the work programme of the Smart Grids Forum (SGF)¹. The SGF was established by Ofgem and DECC in early 2011. It brings together key opinion formers, experts and stakeholders involved in the development of a GB smart grid, with the aim of providing strategic input to help shape Ofgem's and DECC's thinking and leadership in smart grid policy and deployment. It also aims to help provide the network companies and the wider stakeholder community with a common focus in addressing future networks challenges, and to provide drive and direction for the development of smart grids.

One area that the SGF has chosen to focus on initially is the provision of an evaluation framework for smart grid investment. This reflects the current lack of understanding about what really drives the smart grid case, which could inhibit policy decisions and will make assessment of investments difficult in RIIO-ED1 if it is not addressed.

The evaluation framework is the second of five SGF work streams. The other workstreams cover:

- the development of scenarios for future demands on networks (WS1);
- the assessment of required network developments in the low-carbon economy, including detailed network modelling of smart grid options (WS3);
- mitigation of the risk that short term smart meter and smart grid decisions may close off options (WS4); and
- development of future ways of working for the SGF (WS5).

¹ The terms of reference are available here
<http://www.ofgem.gov.uk/Pages/MoreInformation.aspx?docid=7&refer=Networks/SGF>

1.1 Objectives of this project

The aim of this project is to produce a high level framework for the evaluation of smart grids. In developing this framework, we are looking to help the industry reach a better understanding of:

- the drivers of the value of smart grids;
- the value of the flexibility smart grids may provide under conditions of uncertainty; and
- the parties in the value chain that will benefit from smart grid solutions.

It is recognised that a framework for evaluating the value of smart grid solutions is important if DNOs are to justify smart grid investments when the benefits are less certain than for more conventional solutions. In particular, the framework will help Ofgem and others to identify the types of investments in the next price control period where:

- the benefits to the DNO already outweigh the costs it will incur, meaning that there is a strong a priori case for investment;
- the benefits to the DNO are lower than the costs it would expect to incur, but the investment would be NPV positive if the DNO took into account the costs and benefits to others; or
- there are future scenarios where smart grids will be worthwhile and there are reasons why investment should be undertaken now (to trial the solution or because the investment has a long lead time).

Although our model could be used to identify the types of smart grid investments which are likely to be beneficial under different conditions, it will not be at a sufficient level of detail to be used to justify specific smart grid investment plans. The principles that sit behind the framework to enable this evaluation, however, could be transferrable.

1.2 Work plan for this project

This report is the output of the first of three stages in the development of the evaluation framework. The three stages to the evaluation are as follows:

- **Stage 1: Key factors to include in the evaluation.** We have gone through a process of research and analysis with the aim of setting out for consultation the key factors to include in an evaluation of smart grids, and describing our proposed methodology for undertaking the analysis. This report covers:
 - an assessment of the network user needs that drive the value of smart grid solutions; and

- identification of the parties that incur the costs of deployment, and the parties that realise the value delivered.

We describe our proposed methodology for the evaluation, setting out where we intend to focus the analysis and the assumptions we intend to make. We also highlight where these assumptions can be updated as new information arises, and where certain aspects need to be locked down during the model development stage.

- **Stage 2: Model development.** Based on the learning from Stage 1 and comments received during the consultation period, an evaluation model will be developed that is capable of quantifying the costs and benefits of smart grid deployment opportunities at a high level.
- **Stage 3: Learning.** This evaluation will not seek to put a single value on the benefit of a smart grid. However, during stage 3, the evaluation model will be used to investigate the range of values for smart grid solutions which are likely under different scenarios. This will increase our understanding of the value of smart grid investments relative to conventional investments.

1.3 Objectives of this report

The aim of this report is to consult on our overall methodology for the smart grid evaluation and the factors that we intend to include in the modelling.

It is crucial that our model captures the most important factors that will determine the net benefits of investing in smart or conventional solutions. However, at the same time, if it is to act as a practical tool, the model needs to be simple enough to maintain transparency and flexibility.

We therefore need to strike a balance between ensuring the model is comprehensive, while at the same time focussing it in on the factors which most impact on the value of smart grids.

In this report we set out how we intend to take this approach. We welcome comments in particular on:

- our overall real options-based evaluation framework;
- our assessment of the value drivers of smart grids;
- the smart grid strategies we intend to assess;
- our proposed assumptions on smart meter functionality;
- our approach to including smart technologies in the model; and
- the detailed model specification.

The consultation period will run until December 16th 2011. Responses should be sent to lia.santis@ofgem.gov.uk.

The remainder of this report is divided into five sections:

- Section 2 provides an overview of our proposed framework for evaluating the costs and benefits of smart grids;
- Section 3 sets out our assessment of the key value drivers of smart grids, and describes our approach to building scenarios for these value drivers;
- Section 4 describes the business-as-usual case, the smart grid strategies and the technologies that go in to making them up;
- Section 5 sets our initial assessment of the spread of costs and benefits across the value chain; and
- Section 6 describes how our evaluation framework will be captured in the model.

We highlight a set of questions for consultation at the end of each section.

2 Smart grid evaluation framework

In this section, we provide an overview of our proposed framework for evaluating the costs and benefits of smart grids:

- we begin by describing what we mean by a “smart grid” and how smart grids build upon smart meters in terms of the functionality that they provide;
- we then provide an overview of the key questions about smart grids that our analysis will seek to address; and
- finally, we describe the evaluation framework that we propose to use to address these questions. We consider the key complexities associated with developing and applying this framework, and explain how the framework can be best adapted to meet these complexities.

2.1 What do we mean by a “smart grid”?

There is no single agreed definition of a smart grid. We use the *Smart Grid Routemap*² developed by the ENSG as our starting point, which states that:

[A] smart grid is part of an electricity power system which can intelligently integrate the actions of all users connected to it - generators, consumers and those that do both - in order to efficiently deliver sustainable, economic and secure electricity supplies.

Expanding on this, DECC identified that a smart grid is likely to have the following characteristics³.

- **Observable:** the ability to view a wide range of operational indicators in real-time, including where losses are occurring⁴, the condition of equipment, and other technical information.
- **Controllable:** the ability to manage and optimise the power system to a far greater extent than today. This can include adjusting some demand for electricity according to the supply available, as well as enabling the large scale use of intermittent renewable generation in a controlled manner.

² ENSG (2010) *A Smart Grid Routemap*

³ DECC (2009) *Smarter Grids: the opportunity*

⁴ We note that the prominence given to loss management in this definition has been questioned.

- **Automated:** the ability of the network to make certain automatic demand response decisions. It will also respond to the consequences of power fluctuations or outages by, for example, being able to reconfigure itself.
- **Fully integrated:** integrated and compatible with existing systems and with other new devices such as smart consumer appliances.

At the transmission level, the network is already relatively “smart”, given its requirement to manage frequency, voltage and current in an active manner. Our evaluation framework will therefore focus on “smart” investments at the distribution network level, where networks are currently more passive. Distribution Network Operators (DNOs) typically operate networks with relatively straightforward flows of electricity. Although DNOs can point to a few examples where they have made trade-offs between investment and active management options, DNOs have, in general, limited experience of active management. Many of the near term activities required to deliver a low-carbon energy sector require the current electricity distribution network to become more flexible. Smart grids are therefore likely to be focussed on the distribution networks.

The high-level definition set out above describes smart grids in terms of the functionality that they provide. To give our analysis traction in practice, however, we will need to identify the mix of technologies that would be capable of providing this functionality. Section 4 below provides a detailed overview of the “smart” technologies we propose to initially include in our model.

Smart meters are a component of the wider smart grid. However, it should be recognised from the outset that our analysis draws a clear distinction between “smart grids” and “smart meters”.

- Smart meters are being rolled out to all domestic users by 2019, irrespective of whether any additional investment in smart grids takes place. Smart meters alone may make electricity consumption significantly more observable, controllable and automated than it currently is.⁵
- While the planned smart meter rollout will contribute towards the ‘smartness’ of the electricity system, under the current smart meter specification, not all smart meter functionality will be available at distribution network level. For example, smart meters on their own will not enable DNOs to actively shape the demand of households on their feeders.

⁵ DECC (2010) *Impact assessment of GB-wide roll out of smart meters for the domestic sector* <http://www.ofgem.gov.uk/e-serve/sm/Documentation/Documents1/DECC%20-%20Impact%20assessment%20-%20Domestic.pdf>, p. 14

- It is therefore important that the evaluation of smart grids focuses on assessing the incremental costs and benefits of smart grids. In other words, our analysis seeks to identify and measure the additional functionality that smart grids would provide, over and above the functionality provided by the planned smart meter rollout.

Our detailed assumptions on smart meter functionality are set out in Section 4.1.2 below. Section 4.2.2 sets out our assumptions regarding the additional functionality provided by the smart grid technologies we are assessing.

2.2 Key questions for evaluation framework

We propose to develop an analytical framework that will assess the costs and benefits of using smart grid solutions to help address the challenges that the GB electricity sector faces over the coming decades.

Our analysis will have the following scope:

- **We will focus on the impact of smart grid investments at distribution network level:** A framework to assess the costs and benefits of smart grid investments on the distribution network will be developed. The modelling of these investments will be carried out at a high level and will complement the more detailed and granular network modelling being carried out under SGF WS3.
- **We will seek to identify costs and benefits across the electricity sector, and to society as a whole:** Specifically, our analysis will consider the impact of smart grid investments across the following groups:
 - **distribution networks** – as we discuss below, smart grid investments could have implications for the need for reinforcement on the distribution networks.
 - **transmission networks** – it is conceivable that smart grid investments could also have some indirect implications for the need for reinforcement and balancing on the GB transmission network. We assess whether this is the case in Section 5.
 - **generation/suppliers** – smart grid investments could affect consumption load profiles on different parts of the network, which would have implications for the mix and profile of generation, which in turn will affect suppliers' costs.
 - **customers** – customers will be affected, for example, by any change in costs across the electricity sector that are driven by smart grids.

- **society as a whole** - we will also assess the net costs and benefits to society as a whole. Here we will focus on the overall change in costs and benefits to Great Britain, rather than the costs and benefits that are simply transfers between different groups in society. This overall assessment will include an assessment of any change in carbon emissions⁶.
- **We will take a long-term view:** To span the lifetime of the assets under question, our model will consider the implications of smart grid investments between 2012 and 2050. However, our focus is very much on the near term. We will use the model to consider what these long-term implications mean about the case for smart grid investment in the near term.

2.3 Overview of evaluation framework

At its simplest level, our analysis will consist of six steps, as set out in Figure 1 below:

⁶ We will value carbon emissions in line with Government guidance, http://www.decc.gov.uk/en/content/cms/about/ec_social_res/iag_guidance/iag_guidance.aspx

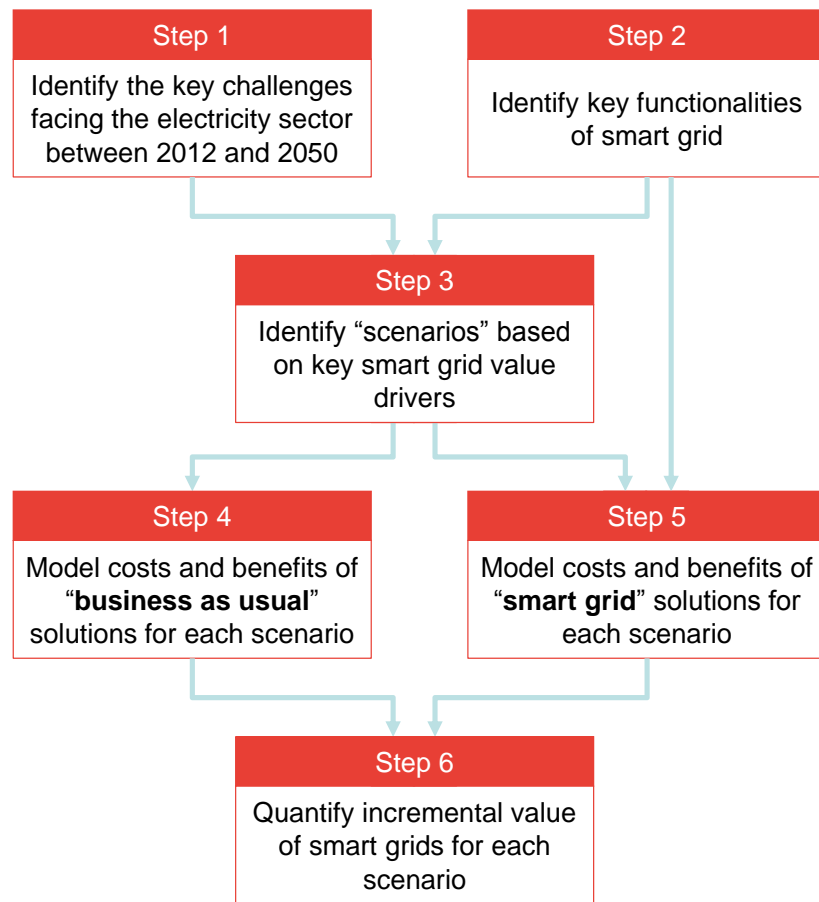
Figure 1. Schematic overview of proposed framework for evaluating smart grid value

Source: Frontier Economics

As Figure 1 above sets out:

- first, we will identify the key challenges likely to be faced in the electricity sector to 2050;
- second, we will identify the key functionalities of smart grids at a high level;
- third, we identify the drivers that could make smart grids more or less useful in helping the industry respond to the key challenges identified in Step 1; we will then use these value drivers to determine a set of scenarios for analysis⁷;

⁷ We will base these scenarios on the outputs of SGF WS1, as described in Section 3.

- fourth, we will model how the industry would address the key challenges that it faces in the absence of any smart grid investments (we call these the “business-as-usual solutions”) for each of the scenarios identified;
- fifth, we will model how the industry would address the key challenges that it faces if smart grid investments were undertaken (the “smart grid solutions”) for each of the scenarios identified; and
- finally, for each scenario, we will evaluate and then compare the costs and benefits of these smart grid and business-as-usual solutions; in this way, our framework will help Ofgem and the industry to take an informed view about the likely incremental value of rolling out smart grid technologies.

At a high level, therefore, the structure of our proposed analysis is relatively straightforward. In practice, however, a number of complexities need to be taken into account. In what follows, we set out and discuss each of these complexities, and consider what they imply for our evaluation framework.

2.3.1 Key complexities and their implications for our evaluation framework

It is well recognised that developing a smart grid evaluation framework involves a number of challenges. The complexities that will need to be addressed include the following.

- **Smart grids as enabling technologies:** A smart grid may help meet decarbonisation and security of supply goals. However, it will not be the only means to achieving these goals. It is important to ensure that this evaluation focuses on smart grids as a means to achieving decarbonisation and security of supply objectives, rather than evaluating decarbonisation and security of supply as ends in themselves.
- **Multiple solutions:** A smart grid is not one technology. There are multiple solutions available in different combinations and for different circumstances. Some of the technologies that comprise a smart grid may be interdependent in the sense that the benefits of one technology cannot be unlocked without the presence of another. Moreover, they may need to be coordinated by a communications structure to work in concert. Conversely, other smart technologies may be functional substitutes, or even mutually exclusive. While solving for the ‘optimal’ mix of smart grid technologies is beyond the scope of this project, our evaluation framework must pay close attention to these potential interactions between technologies, rather than assessing their costs and benefits in isolation. In particular, we will aim to compare the costs and benefits of rolling smart grids out in a coordinated “top-down” or

Smart grid evaluation framework

“holistic” fashion, with those associated with rolling these technologies out incrementally on a reactive basis.

- **Scale and profile of investment required:** Conventional and smart grid solutions may differ with regard to the dynamic profile of the investment and the scale of investment required to realise any benefits. For example, conventional technologies may tend to be capital-intensive but have longer asset lives. Smart grid solutions may tend to be less capital-intensive, but may also have shorter asset lives. Our evaluation must take these differences in investment profile into account.
- **Uncertainty and option value:** It is well recognised that there is considerable uncertainty about the future demand and supply conditions in the electricity sector. Many of these uncertainties are driven by policy (e.g. the credibility of future carbon targets and the additional policies that may be in place to drive particular solutions). It will be important to ensure that our evaluation does not just help us understand which technology performs best under a given future scenario, but also which technology is likely to be most desirable given this uncertainty over future scenarios. In practice, this means:
 - considering more than one possible scenario; and
 - taking account of any differences in the “option value” provided by different smart grid strategies (i.e. the extent to which committing to a particular investment plan today would lock networks into that strategy for the long run, as opposed to giving them the option of modifying their strategy in future years as new information becomes available).
- **Uncertainty over the level and value of demand response:** Some smart grid technologies will allow DNOs to harness demand side response (DSR) to reduce network reinforcement costs. Assessing the value of this service is likely to be an important part of an assessment of the value of smart grids. However, there is great uncertainty over the extent to which DSR can be used for this purpose. Firstly, there is uncertainty over how responsive customers will be to signals of various kinds, and secondly, there are a number of competing uses of DSR (notably demand-shifting by suppliers to reduce wholesale energy costs), which will have different values under different conditions. Our evaluation framework will take account of both supplier-led and DNO-led DSR, as well as alternative sources of flexibility such as pumped storage and OCGT.
- **Disaggregated costs and benefits:** The supplier hub model, together with network separation and involvement from many other parties such as aggregators, ESCOs and microgen providers as well as customers, means

that the costs and values associated with a smart grid are spread across a number of parties. Further, the costs and benefits are not aligned between these different parties, and they may change over time.

In what follows, we set out how we propose to adapt our evaluation framework so that it takes account of and addresses each of these complexities.

Smart grids as enabling technologies

There are a variety of ways in which smart grid technologies may allow benefits for society to be realised. For example, the smart grid might facilitate the connection of more low-carbon technologies (such as electric vehicles), displacing more polluting technologies and leading to a reduction in emissions. In addition, the increased monitoring of distribution networks could enable increases in the reliability of supply.

Our evaluation framework must focus on assessing the incremental costs and benefits of smart grids relative to conventional distribution grid technologies. It does not aim to capture the costs and benefits associated with decarbonising heat, transport or the electricity sector more widely, or the benefits associated with potential improvements in security of supply⁸.

We consider that such outcomes can generally also be achieved in the absence of smart grid investment (albeit potentially at higher cost), through traditional reinforcement. As such, our model will hold objectives such as overall emissions and supply reliability constant, and will simply compare the costs and benefits associated with different means of achieving these outcomes. However, where the application of different solutions leads to changes in security of supply or carbon emissions as ancillary benefits, we will include these in our evaluation. The following examples may help illustrate this approach:

- Each of our scenarios will contain a certain number of low-carbon technologies such as electric vehicles and heat pumps. We will compare the costs of accommodating these low-carbon technologies with smart technologies and with conventional technologies. However, we will not assess the costs and benefits of the heat pumps and electric vehicles themselves.
- Each of our scenarios will be associated with a certain generation capacity mix. However, if a smart grid technology changes the profile of demand and thereby changes how that generation capacity is used, we will include the

⁸ We recognise that increased electrification of heat and transport is likely to increase the value of lost load and hence the justification for security of supply improvements. However, assessing the likelihood of such a change is beyond the scope of this project.

Smart grid evaluation framework

resulting change in emissions in our evaluation. Where DSR can reduce the need for spinning reserve, the emissions and cost implications will also be taken into account.

- Where a smart grid technology is applied to accommodate low-carbon technologies, but brings with it an improvement in quality of supply over and above today's standards, we will note the associated improvement of quality of supply in our assessment. However, we will not compare alternative ways of exceeding today's quality of supply standards.

Figure 2 sets out our proposed approach. As described above, we aim to focus on the potential of smart grids and conventional solutions as alternative means to achieving energy sector aims, rather than assessing the costs and benefits of these aims themselves.

Figure 2. Overview of proposed approach

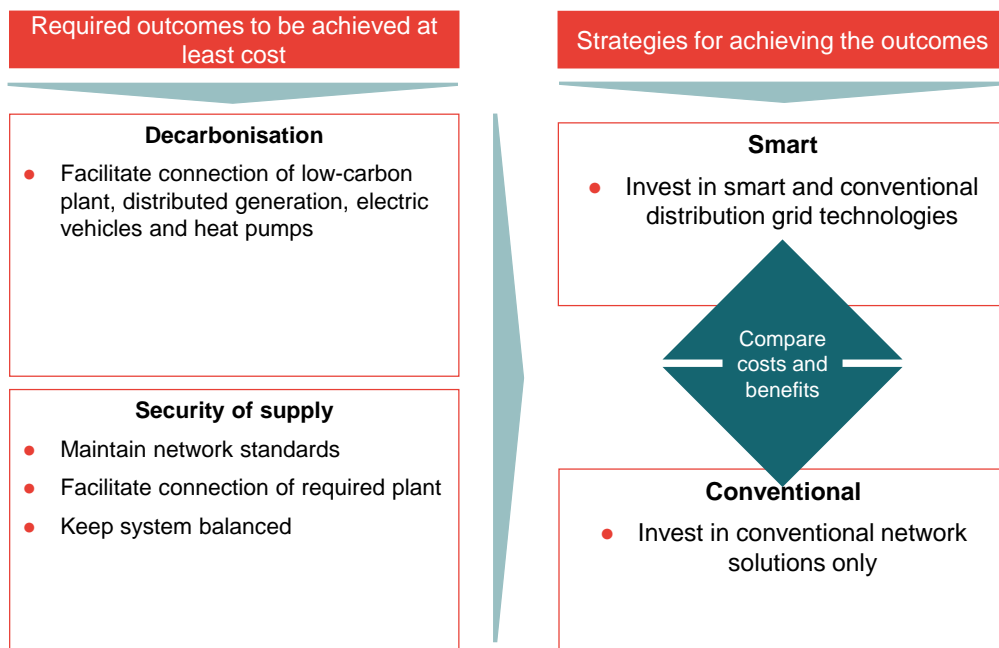

Source: Frontier Economics

Multiple solutions

A smart grid is not just one technology, nor is it a well-defined package of technologies. Instead, a smart grid could be made up of a range of technologies that can be applied in different combinations and at different geographical scales.

Given interdependencies between the functionality of different smart grid technologies, the costs and benefits of each individual technology are likely to be dependent on whether other technologies have been rolled out. Because of these

interdependences, rather than assessing the incremental costs and benefits of each individual smart grid technology in isolation, it makes sense to assess the costs and benefits of representative smart grid investment packages or strategies.

We intend to assess two smart grid investment strategies. These will be compared to a business-as-usual strategy, where only investments in conventional grid technologies are undertaken (over and above existing policies to rollout smart meters). Each strategy assessed will entail enough investment to at least maintain current levels of security of supply, and to facilitate the same amount of connections of low-carbon plant and demand side technologies (as illustrated in Figure 2). The strategies will differ solely in terms of the means they use to deliver these outcomes.

These alternative strategies are described in Figure 3. Further detail is provided in Section 4 below.

Figure 3. Smart grid investment strategies

	Description
Top-down smart grid investment strategy	<ul style="list-style-type: none"> • Coordinated rollout of smart grid technologies across DNO region • Investments applied before need in some areas
Incremental smart grid investment strategy	<ul style="list-style-type: none"> • Investments adopted on an incremental basis, driven by need on individual feeders
Business as usual investment strategy	<ul style="list-style-type: none"> • Conventional investments only • Includes all existing policies, including smart meter rollout

Source: Frontier Economics/EA Technology

Profile and scale of investment required

Smart grid and conventional solutions may differ in the following ways:

- the extent to which they need to be applied in a coordinated fashion to be effective;
- the extent to which they involve up-front capital investment and the subsequent lifespan of these assets; and
- the speed with which they can be deployed.

Smart grid evaluation framework

We discuss the potential relevance of each of these factors for our evaluation framework below.

- **Scale effects:** Some elements of smart grids may need to be applied at a certain scale and in a holistic or top-down manner before some of their benefits are realised. To the extent that this is the case, it would be difficult to invest in a smart grid in an incremental way, not least because this would increase the risk of asset stranding in the event that the requisite scale is not achieved. Other elements of smart grids, by contrast, may yield benefits irrespective of the scale of investment. For these technologies, an incremental investment programme may be more appropriate.
- **Capital-intensity:** Individual smart grid and conventional technologies will have different levels of capital-intensity, (i.e. different levels of upfront costs as a proportion of total costs), and different lifetimes. The higher the capital-intensity and the longer the lifetime, the greater the level of sunk costs associated with any investment and the less flexibility there will be to adjust the response to unexpected supply or demand side developments.
- **Required lead times:** Smart grid solutions may be based on newer technologies than conventional solutions. In some cases, solutions may need to be trialled before they can be rolled out at a large scale. To the extent that this is the case, there may be longer lead times associated with some smart solutions. In other cases, where they help avoid large-scale capital investments which may be associated, for example, with planning delays, smarter solutions may have shorter lead times than their conventional alternatives.

These considerations reinforce the case for considering more than one possible smart grid investment strategy. A top-down centralised investment strategy will typically involve a greater initial investment, but may be more cost-effective in the longer run than an incremental approach that upgrades each section of the network as necessary. Looking at more than one type of smart grid strategy will allow us to take account of the benefits that might arise from a more holistic or top-down approach to smart grid investment. For example, if there are significant scale effects associated with smart grid investment, then it might be that an incremental smart grid investment strategy delivers less value than a business-as-usual investment strategy, but that a top-down smart grid rollout delivers more value than business-as-usual. Conversely, under different conditions, the additional flexibility in the face of uncertainty provided by the incremental strategy may make it more cost-effective overall than the top-down alternative.

Figure 4 below provides an overview of the potential differences between the investment strategies with respect to proportion of upfront cost and required

lead times. In this figure, front loaded investment refers to the proportion of investment that is incurred up front, not to the absolute scale of the costs potentially associated with each type of strategy.

Figure 4. Investment profiles and lead times

	Description	Front loaded investment	Lead times
Top-down smart grid investment strategy	<ul style="list-style-type: none"> Coordinated rollout of smart grid technologies across DNO region Investments applied before need in some areas 	High	Potentially longer
Incremental smart grid investment strategy	<ul style="list-style-type: none"> Investments adopted on an incremental basis, driven by need on individual feeders 	Low	
Business as usual investment strategy	<ul style="list-style-type: none"> Conventional investments only Includes all existing policies, including smart meter rollout 	Medium	Shorter

Source: Frontier Economics

The effect of uncertainty

There is considerable uncertainty about future demand and supply conditions in the electricity sector. Given the long term of scope of this project (from now until 2050) and the different characteristics of grid investment strategies in terms of their flexibility in the face of uncertainty, our evaluation must take account of this.

This high degree of uncertainty has two important implications for our evaluation framework:

- first, it strengthens the case for considering **more than one possible scenario**; and
- second, it means that we should take account of the “**option value**” that arises from networks having the opportunity to modify their investment strategies in future years in response to new information about the value of smart grids.

We consider each of these implications in turn.

(i) The high degree of uncertainty strengthens the case for considering more than one possible scenario

Smart grid evaluation framework

Given uncertainty over the future, we intend to assess the value of smart grid strategies within three scenarios, which represent different states of the world to 2050.

The SGF has set up a workstream (WS1) to provide information on the expected future demands (in the broadest sense) on electricity networks. WS1 will develop a set of assumptions and scenarios to 2030 for each of the technologies most likely to impact on the value of smart grids.

We intend to build up to three scenarios based on the outputs of WS1. The scenarios should vary the factors which have the greatest impact on the value of smart grids. They should also be consistent with the achievement of Government's policy goals. Each will therefore be consistent with meeting the first four carbon budgets and the 2050 greenhouse gas emissions targets. We will then analyse the investments required to ensure security of supply under each scenario separately for each of the strategies referred to above.

The scenarios will be put together once we receive the outputs of WS1. In Section 3.2, we describe how we will do this.

(ii) The high degree of uncertainty also means that we should take account of the “option value” of different smart grid strategies

The uncertain background against which smart grid investment decisions need to be taken makes conventional cost-benefit analysis (CBA) techniques difficult to apply. In particular, a standard CBA may lead to misleading results when assessing options over time under conditions of uncertainty. For example, under a standard CBA, which implicitly assumes perfect foresight, a capital-intense option might have a higher net present value than an option that has high ongoing costs, but no upfront costs. Once uncertainty over the future outturn scenario is taken into account, the latter approach might look more sensible, because of the flexibility associated with it: you can choose not to run it if it turns out not to be needed.

Therefore a more innovative method of evaluation needs to be applied. This method needs to be able to factor in the option value associated with early investment in flexible solutions (i.e. potentially ahead of need) or delaying investment until more information is available.

Given the uncertainty inherent in the future of the electricity system and the mix of investment options with different cost structures, we intend to use the principles of “real options” analysis in our cost-benefit analysis.

Real options analysis recognises the possibility that, under some circumstances, networks might be able to adapt their investment strategies in future years as new information about the utility of smart grids becomes available. This allows the evaluation framework to take account of the option value associated with any

smart grid investments that avoid lock-in to a particular investment path. Examples of investments with option value may include:

- investments that can be incrementally augmented in future periods;
- investments that promote learning, and which may therefore make future investments less costly or more feasible; and
- investments with lower capital costs, but higher operating costs.

Real options analysis allows the best strategy to be chosen in the face of uncertainty, by factoring in:

- the impact of new information on the state of the world into the analysis at a decision point in the future; and
- the extent to which the investment strategy today facilitates or limits the ability of networks to adjust their investment strategies when this new information becomes available.

We intend to capture the differing option values associated with the different strategies by looking at the costs and benefits across two time periods. The first time period would stretch from 2012 until the mid-2020s, and the second would then stretch from the mid-2020s out to 2050.

We propose to use the year 2023 for the decision point in our decision tree analysis as this is likely to coincide with the beginning of the first price control period after the completion of the smart-meter rollout and so is likely to be a natural point for the industry to adjust its smart grids strategy if necessary⁹.

Having identified these two time periods, we will first run a standard CBA on the first period, where the costs and benefits of each strategy are assessed for each scenario.

We will then analyse the second time period. For each strategy that has been chosen at the first decision point (2012), there will be a set of strategies that are still possible at the second decision point (2023). However, not all will be possible: for example, if a top-down strategy has been chosen in 2012, it may not be possible to resort to an incremental approach to smart grids in the mid-2020s without stranding a number of assets.

For each scenario, therefore, we will identify the best available strategy at the second decision point (2023), given:

- the assumed scenario; and

⁹ We note that the industry would begin to discuss any changes to its smart grid strategy for ED2 several years before 2023, however, the actual changes would be more likely to occur from the beginning of ED2 in 2023.

- the optimal investment strategy associated with this scenario, subject to the constraints imposed upon the set of available strategies by the investment strategy chosen at the first decision point (2012).

The final step will be to add together the results of the conventional CBA for the first period with the results of the CBA for the second period to identify a total net present value (NPV) benefit measure for each scenario and strategy. By weighting the NPV benefit estimates by assumed probability of each scenario occurring, we can identify a single probability-weighted NPV benefit estimate for each investment strategy.

Figure 5 below provides a diagrammatic illustration of the proposed “real options” approach that we have described above.

Figure 5. Real options based approach

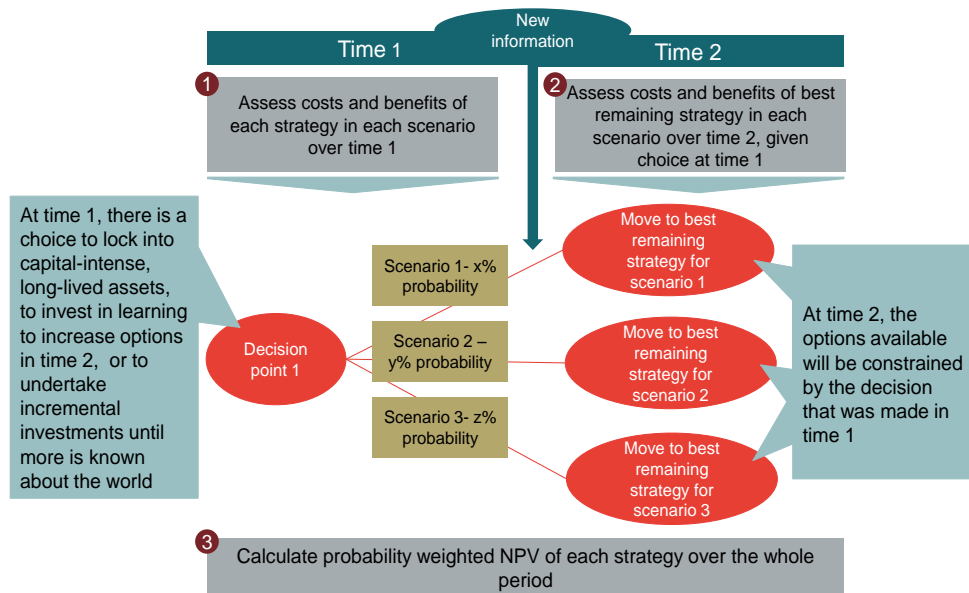

Source: Frontier Economics

We believe that this kind of decision tree analysis will provide the right balance between accounting for uncertainty and avoiding the spurious accuracy which might be associated with a more data-intense modelling approach.

- Decision tree analysis takes the principles of real options analysis and ensures that path dependency is accounted for. This ensures that investments that keep options open are valued more highly than investments which lock-in to a certain path.
- At the same time this analysis maintains simplicity and transparency. Rather than requiring the inevitably subjective development of detailed probability

distributions around key variables in the model and their interdependencies, decision tree analysis allows assumptions on the probability of each scenario to be kept explicit, and changeable for the use in sensitivities. By limiting the decision tree to two periods, we will be able to take account of the different option values associated with different smart grid investment strategies without allowing the evaluation framework to become too complex.

Uncertainty over the level and value of customer demand response

The extent to which DSR is possible will be an important determinant of smart grid value:

- The use of DSR by suppliers (to reduce generation costs) could lead to increased peaks on the distribution networks. To the extent that smart grid investments may enable DNOs to upgrade their networks to cope with this at lower cost, demand-side response by suppliers will act as a value driver for smart grids.
- Smart grid investments may themselves allow DNOs to carry out DSR of their own, to reduce peak flows locally.

However, it is currently highly speculative as to what level of demand response may be feasible. There are two issues:

- **How responsive customers are:** Time-of-use tariffs by themselves may not be sufficient to encourage customers to adjust their demand. “Smart” appliances and automated load control would ensure a higher level of response, although it is uncertain to what extent these technologies will be deployed.
- **What the relative value of DSR used in different contexts is:** Previous studies¹⁰ have indicated that the benefits of using DSR for peak-shaving (reducing DNO reinforcement costs) are similar to those obtained by prioritising DSR to minimise production costs (by shifting demand to when electricity is cheapest). There are a multitude of different ways in which DSR can be deployed, which may involve trade-offs between these two types of benefit.

In this evaluation, we do not attempt to provide a bottom-up estimate of the proportion of demand which can be shifted. Instead, simple assumptions regarding the responsiveness of demand will form an input to the model. These will be fully flexible to be changed by users of the model. This approach allows

¹⁰ Poyry (2010), *Demand side response: conflict between supply and network driven optimisation*

more accurate estimates of demand responsiveness to easily be inputted in the future as they become available (for example, from Low Carbon Network Fund projects).

DSR presents further modelling challenges due to the almost limitless number of ways in which demand can be shifted. Ideally, we would consider the most effective use of DSR, however calculating this requires a complex optimisation exercise. We describe in more detail in section 6.5 how we propose to approximate this, while still ensuring a tractable model. In brief, this involves the following process:

- determining the amount of load which can be shifted, based upon the penetration of technologies such as heat pumps and EVs, together with assumptions regarding their responsiveness;
- building a “supplier-led” DSR profile which will lower generation costs by moving demand to where costs are lower; and
- creating an additional “DSR adjusted” profile for those distribution network feeders with the relevant enabling technology. This will be based on the “supplier-led” profile, but will shift demand away from the peak if the design capacity of the feeder would be breached.

Disaggregated costs and benefits

The costs and values associated with a smart grid may be spread across a number of parties. They may not be aligned between these different parties, and they may change over time.

We will first undertake a cost benefit analysis from the perspective of GB society as a whole. However, to inform policy it will also be important to understand where the costs and benefits associated with a smart grid rollout may lie. This will not be evident from the overall net present value of smart grids.

We therefore intend to undertake a high level assessment of the costs and benefits that may accrue to the following parties:

- DNOs;
- customers;
- generation/supply businesses; and
- transmission network owners/operators.

In Section 5 below, we set out how we intend to disaggregate these net benefits across the different groups.

Questions for consultation from section 2

We would welcome comments on the evaluation framework that we have set out in Section 2. In particular, we would welcome comments on whether the following elements of our proposed approach to accounting for the effects of uncertainty make sense:

- Do you agree with our definition of smart grids?
- Have we captured the main complexities associated with assessing the costs and benefits of smart grids?
- Do you agree with our approach to dealing with these complexities in the overall evaluation framework, in particular:
 - We propose to take a two-stage decision tree approach, rather than relying on a conventional CBA framework alone. Does this constitute an appropriate approach, given the need to measure differences in the “option value” that different smart grid investment strategies provide?
 - We propose to use the year 2023 for the decision point in our decision tree analysis. We have chosen 2023 on the grounds that this is likely to coincide with the beginning of the first price control period after the completion of the smart-meter rollout and so is likely to be a natural point for the industry to take stock and adjust its smart grids strategy if necessary. Do you agree that the year 2023 constitutes an appropriate “break point” in this regard?

3 Value drivers and scenarios

The aim of this section is to set out for comment our view of the key value drivers of smart grids, and to describe our approach to building scenarios for these value drivers. We cover this in two stages:

- **Value drivers of smart grids.** This section provides an overview of the challenges likely to be faced by the electricity sector to 2050. Where smart grids can help deal with a challenge, the challenge becomes a value driver for smart grids.
- **Scenarios.** This section sets out our approach to developing scenarios, based on varying the levels of those smart grid value drivers over which there is the most future uncertainty.

While it will be possible for the user to vary the numbers associated with each value driver in the model we are producing (e.g. the numbers of electric vehicles or heat pumps), adding new value drivers would require amendments to the model. We are therefore particularly interested in views on the following:

- our assessment of the demand and supply side technologies that drive the value of smart grids; and
- our assessment of the factors which it is most important to vary across scenarios.

We also welcome views or the submission of new evidence on the detailed assumptions we propose to make on the characteristics of each technology.

3.1 Smart grid value drivers

This section describes at a high level how the smart grid may help tackle the challenges likely to be faced in the electricity sector to 2050. It then assesses the likely relative importance of varying the level of these challenges across the different scenarios that our evaluation framework will consider. A challenge will be important to vary across scenarios if:

- it is an important value driver of smart grids; and
- there is a great deal of uncertainty over its future level of deployment.

3.1.1 Overview of value drivers

It is crucial that we understand how the value of a smart grid will vary depending on the timing and mix of the supply-side and demand-side challenges facing the networks.

Challenges

As we set out in our previous report to the SGF¹¹, there are three broad policy drivers which drive the potential value of a smart grid.

- **Carbon targets:** The primary drivers for change are the first four carbon budgets, which set limits on emissions out to 2027, and the 2050 carbon reduction targets. Achievement of these targets is likely to require the almost complete decarbonisation of the electricity sector.
- **Security of supply:** There is also a need to ensure secure and sustainable energy supplies into the future given changing supply and demand patterns.
- **Affordability:** This will have to be achieved while ensuring that networks continue to deliver long term value to existing and future customers.

These policy drivers create demand-side and supply-side challenges for the energy sector.

- **Electrification of transport and heating:** Low-carbon electricity will increasingly be used for transport and heating, adding to total demand, but potentially providing a source of flexible and controllable demand (and embedded storage) that could be exploited via smart technology.
- **Integration of distributed generation:** An increasing number of distributed generators (which may or may not be despatchable) will be connected to local distribution networks rather than the national transmission network. This will make the power flows on distribution networks more complex and less predictable.
- **Integration of inflexible intermittent generation:** More electricity will be generated from renewable sources like wind which are intermittent, or nuclear, which is relatively inflexible.

Added to this is the ongoing requirement for the network companies to **drive for network efficiency**.

Although much of the change required to meet these challenges will be at the generation and demand ends of the energy supply chain, networks, as the link between them, will also have to respond.

¹¹ Frontier Economics (2011), *How to deliver smarter grids in GB*, http://www.frontier-economics.com/_library/publications/frontier%20report%20-%20how%20to%20deliver%20smarter%20grids%20in%20gb.pdf

The role of smart grids

As a result of the demand-side and supply-side developments set out above, distribution network flows are expected to be less predictable and more volatile. This means that the networks themselves, and the devices connected to them, will have to be more controllable. To the extent that they provide network operators with additional control, smart grid technologies could therefore help networks to respond to these challenges. Smart grids are likely to provide the following benefits in this regard.

- **More information:** smart grids can provide network operators with more information about the state of their networks and the connected load and generation. This information can be used to inform decisions both about the physical operation, maintenance and replacement of the network itself, and on the management of electricity flows.
- **More configurability:** smart grids can provide network operators with greater ability to reconfigure their networks, to manage the flow of electricity around them. This in turn should allow use of existing network capacity to be optimised.
- **Controllability of load and generation:** smart grids should allow network operators to influence the offtake and injections of connected load and generation. This should allow such offtakes and injections to be matched more effectively to the available capacity of the network, again allowing more effective utilisation and helping to reduce or delay requirements for expansion by alleviating pressures on network headroom.
- **Controllability of embedded storage:** smart grids should also allow network operators to control embedded storage (assuming this becomes a cost-effective technology), again helping to optimise network utilisation and to reduce or delay expansion.

In what follows, we consider each of the demand and supply side challenges raised above in more detail, and consider the interaction between these and the ways in which smart grids can add value. Further details on the technical characteristics of the low-carbon technologies driving these challenges is provided in Annexe B.

3.1.2 Electrification of transport and heating

There is a broad consensus that the electrification of transport and heating will be required, alongside the decarbonisation of electricity supply, to meet long term carbon emission reduction targets.¹²

Electrification of heat and transport will cause:

- a large increase in load;
- a change in the profile of load; and
- a change in the proportion of demand that is flexible (for example, it may be possible to switch off electric vehicle charging points or domestic heat-pumps for short periods at certain hours of the day).

This suggests that the utility of smart grids could increase with the electrification of heat and transport for two reasons.

- **Smart grids could help defer the need for thermal reinforcement.** Increases in load as a result of the electrification of heat and transport could lead to an increased peak demand on many parts of the distribution networks, particularly if the profile of this new load is similar to existing load profiles. This could result in peak load flows exceeding the rating of some primary substations, as well as a number of distribution substations at lower voltage levels. This would require network operators to reinforce a number of network assets, such as transformers, circuits, circuit terminations and switchgear. Recent studies suggest that the typical cost of such thermal reinforcement at a primary substation alone could be as high as £5m for 15-25 MW.¹³

Smart grids could potentially help to reduce (or at least defer) the need for costly thermal reinforcement on some parts of the network in three ways:

¹² For example, the UK Government's *Carbon Plan* (2011) cites both the electrification of transport and the electrification of heating as developments that will be fundamental if the UK is to meet its carbon emission reduction targets:

<http://www.decc.gov.uk/assets/decc/What%20we%20do/A%20low%20carbon%20UK/1358-the-carbon-plan.pdf>

¹³ For example, a recent (April 2011) study undertaken by Frontier Economics for the Energy Networks Association found that the typical thermal reinforcement cost at a primary substation would be in the region of £4.7 million. See:

<http://2010.energynetworks.org/storage/DOC%20-%20ENA%20final%20report%20-%2001-04-11%20-%20STC.pdf>

- first, smart grid technologies may enable network companies to shift around additional load associated with electric transport or heating so that it no longer coincides with peak demand;
 - second, smart grids may incorporate technologies that allow network operators to increase the operational thermal capacity of transformers and circuits under certain conditions;¹⁴
 - third, smart grid technologies may enable network companies to reconfigure their networks near to real time to ease network constraints and dynamically align network capacity with demand.
- **Smart grids could help alleviate other network pressures associated with the electrification of heat and transport.** As we explain below, the electrification of heating could create problems for voltage profiles on those parts of the network where load is already high. At times of coldest temperature, demand is likely to be higher. As a result, the voltage reduction associated with the electrification of heating could cause difficulties from a network perspective as it will exacerbate the worst-case conditions.

Again, smart grids could potentially help to circumvent these problems in two ways:

- first, smart grid technologies may enable network companies to temporally manage load associated with electric transport or heating so that it no longer coincides with peak demand, thereby reducing downward pressure on network voltage at these times;
- second, smart grid technologies may provide network operators with enhanced network voltage control tools that allow them to mitigate pressures on network voltage directly.

Having considered at a high level the challenges which electrification of transport and heating will create and the ways in which smart grids may help, we now consider the characteristics of the technologies that are likely to drive this process of electrification, namely heat pumps and electric vehicles. For each of these technologies, we cover the following issues:

- **Overall penetration of technologies:** The extent to which these technologies will play an important role in decarbonisation to 2050, and the extent therefore that they are likely to be prevalent.

¹⁴ It is unlikely that the actual physical constraints of the units can be changed (though they may be) however with more information DNOs may be able to run closer to the limits or trade off asset life for thermal headroom.

- **Changes in load profiles:** the impact of these technologies on demand profiles, and the impact they will therefore have on the value of demand side response and the quantity of demand that will be available for demand side response.
- **Network issues and smart grid value:** the nature of the impact that rollout of these technologies is likely to have on networks, and hence the added value from smart grid technologies.
- **Clustering of technologies during rollout: the extent to which technologies are clustered.** The impact on networks will be determined by the clustering of technologies as well as its overall penetration on the grid, as increased loads within a small area will have a greater network impact than the same increase in load dispersed across GB.

Heat pumps

Heat pumps work by moving thermal energy from the ground or air into the building being heated, using electricity in the process.

(a) Penetration

Over the longer term out to 2050, heat pumps will have to be highly prevalent if carbon targets are to be met (for example, in DECC's *2050 Pathways* analysis¹⁵, 60-90% of all homes are expected to be driven by heat pumps, by 2050). There is uncertainty over the speed at which heat pumps will be rolled out. Government is 'committed to the ambition' that 12% of heating will be from renewable sources in 2020¹⁶, around two-thirds of which is planned to be from heat pumps¹⁷. However, some of this renewable heat could be provided from other sources, for example from biomass.

(b) Changes in load profiles

Load from heat pumps is likely to be highest in winter and during the day. An example of a daily residential heat pump profile for a cold winter day is shown in Figure 6. The "Without Store" series presented has been created from five days of load data taken during winter 2008 from an electricity substation supplying 19

¹⁵ See <http://www.decc.gov.uk/en/content/cms/tackling/2050/2050.aspx>, accessed 05/10/11

¹⁶ DECC (2011), *Renewable Heat Incentive*, <http://www.decc.gov.uk/assets/decc/What%20we%20do/UK%20energy%20supply/Energy%20mix/Renewable%20energy/policy/renewableheat/1387-renewable-heat-incentive.pdf>

¹⁷ DECC (2010) National Renewable Energy Action Plan, <http://www.decc.gov.uk/assets/decc/what%20we%20do/uk%20energy%20supply/energy%20mix/renewable%20energy/ored/25-nat-ren-energy-action-plan.pdf>

properties¹⁸, 18 of which had heat pumps installed. Weather conditions were amongst the coldest experienced in recent years, the average daily temperature during the five days being +3°C, and the minimum being -5°C. .

The “Thermal Store” series in Figure 6 presents an interpretation of how a commercially available thermal store¹⁹, could be charged and controlled to reduce the contribution of heat pumps to peak demand, which occurs here at around 17:00. For this example, storage can be seen to reduce the daily peak in demand from the 18 heat pumps by 5 kW²⁰. The reduction achieved is shown for illustrative purposes only, as it is based on several assumptions and is overlaid onto the heat pump demand profile²¹.

Figure 7 sets out an estimated profile for a commercial heat pump on a winter’s day²². This has been based on a set of assumptions about the building, the weather and the heat pumps²³.

Load from heat pumps is likely to be relatively inflexible unless the heat pump is accompanied by storage technology (e.g. a hot water tank), or has been installed in a very well insulated home²⁴. It is likely that some residential heat pumps will have storage, and thus that some heat pump load will be flexible. Heat pump load from commercial installations is likely to be less flexible however. Given the relatively flat profile of commercial heat load (as shown in Figure 7), there is not likely to be much scope for storage to improve this.

¹⁸ S.D. Wilson, Monitoring and Impact of Heat Pumps, Strategic Technology Programme, Project S5204_1, October 2010

¹⁹ Gledhill, BoilerMate BP Technical Specification, available at www.gledhill.net, accessed October 2011.

²⁰ Although the reduction in demand at 17:00 from heat pumps is considerably more, the peak demand over the course of the day falls by 5kW.

²¹ Key assumptions in creating this series are: 35°C useful temperature range in the thermal store, store comprised of 190 litres of water, recharging of the store starts from 01:00 and recharging occurs over 4 hours at night, and that the demand of non-heat pump loads is 0.8 kW around the time of peak demand. The heat pump is simply turned off in order to reduce peak demand.

²³ The profile has been developed based on several assumptions, which have allowed the UK service-sector average energy consumption for heating²³, 30W/m², to be related to a Winter’s month. Assumptions are: Co-efficient of performance = 3.0, base temperature = 15.5C, average daytime December air temperature = 2.8C and December degree-days = 311²³. A “Small” office has been defined as 1,000m², with “Medium” 5,000m² and “Large” 10,000m². Heating is required for 12 hours, 06:00 to 18:00, the effects of thermal mass and cooling requirements are neglected. A real profile would change due to many factors. Cycling would also be evident. .

²⁴ Very well insulated homes (e.g. post-2016 zero carbon) also increases flexibility of heat pump demand (i.e. because home ambient temperature degradation rates are very low)

Figure 6. Typical domestic heat pump profile with stylised storage element

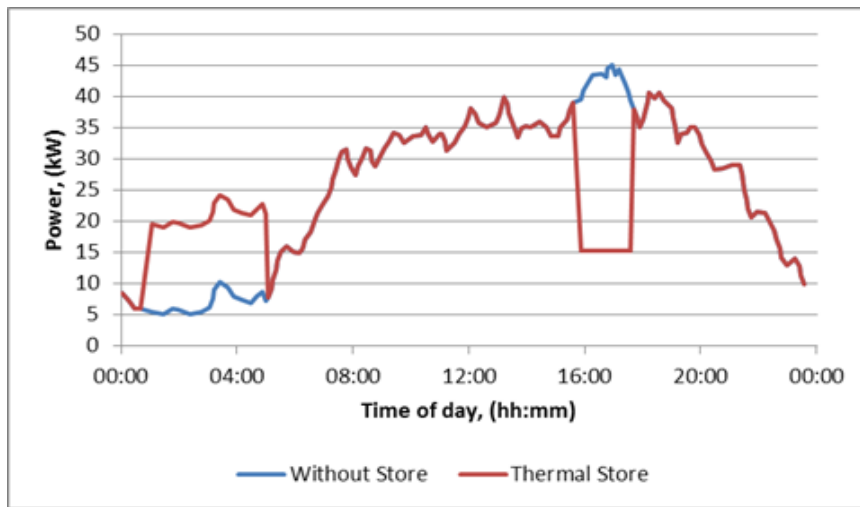

Source: EA Technology²⁵

Figure 7. Estimated commercial heat pump profile

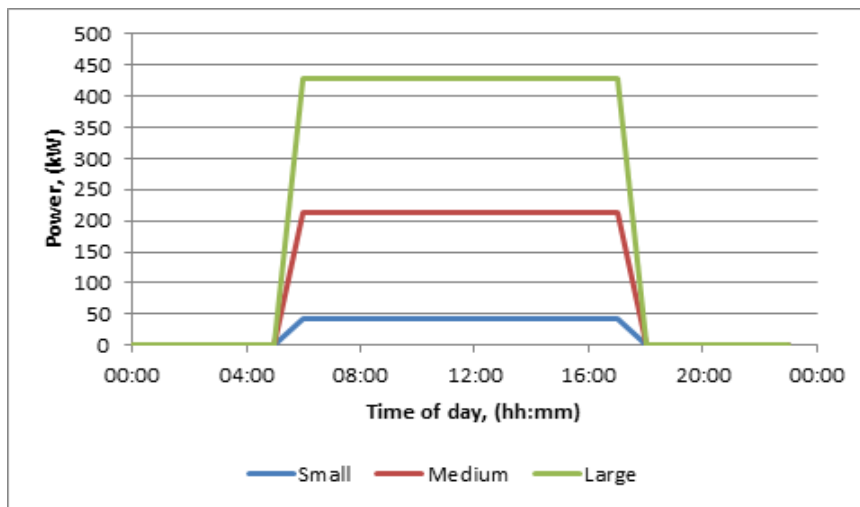

Source: EA Technology²⁶

²⁵ S.D. Wilson, Monitoring and Impact of Heat pumps, Strategic Technology Programme, Project S5204_1, October 2010

²⁶ This is based on the assumptions regarding energy consumption per square metre, listed above

(c) Network issues and smart grid value

The following network issues are likely to arise with the conversion of properties which have previously been heated using fuels such as gas and oil, to electrically-driven heating via heat pumps.

- **Increase in load on the distribution network.** Heat pumps may pose a major challenge for electricity networks because they increase load during the winter and in the early evenings when most peaks already occur.
- **Current surges.** When operating, heat pump compressors cycle according to the heat requirements of the property. Each time the compressor starts up, a surge in current equivalent to many times the normal load current is needed, which, unmitigated (e.g. by soft-starters), has the potential to cause poor power quality in the area.
- **Voltage profiles.** The steady state voltage profile is of concern on weak networks for heat pumps and/or if load is already high. Some heat pumps are equipped with an additional heater to be used when temperatures are at their coldest as, without this heater, the heat pump cannot efficiently meet its heat demand. At times of coldest temperature, demand is likely to be higher and hence this additional demand and associated voltage reduction will cause difficulties from a network perspective as it will exacerbate the worst case conditions.

As a result of these network issues, smart grid technologies have the potential to add value in a number of ways to maximise useful capacity:

- by providing more load and voltage information on the network to allow its capacity to be used to the maximum;
- by configuring the network to manage flows around it as effectively as possible;
- by more actively controlling network voltages; and
- by facilitating demand side response or providing embedded storage to manage peaks in load.

(d) Clustering

In the shorter term (out to the mid-2020s), the impact of heat pumps on the grid is likely to be heavily influenced by the extent to which they cluster on specific feeders. Clustering out to the mid-2020s is likely for the following reasons:

- Heat pumps are most attractive in off-gas-grid areas, where the effects of oil price variability are driving customers to investigate alternatives. Penetration

is therefore likely to be biased towards rural areas, as urban areas tend to have gas and so penetrations may be low initially.

- Social housing providers have driven the installation of heat pumps and social housing tends to be concentrated in certain areas.
- There is a high likelihood of clustering for commercial use of heat pumps around existing commercial centres: village, town and city-centres, business and technology parks.

Such clustering is likely to increase the value of smart grid technologies in locations with high incremental heat pump load.

Electric vehicles

This section considers the impact of residential and car park charging of electric vehicles. Electric vehicles include pure-electric, parallel- and series-hybrids.

We also consider vehicle to grid technology (V2G). V2G technology, whilst not yet available in the UK²⁷, holds promise for the future. V2G requires EVs to be fitted with bidirectional converters, capable of discharging the batteries onto the grid at times of need. It will require control of fleets of electric vehicle chargers and will result in energy transfers across LV networks that are not present today.

(a) Penetration

Over the longer term out to 2050, EVs will have to be highly prevalent if carbon targets are to be met. For example, the Committee on Climate Change estimate that meeting carbon budgets will require electric cars and vans to reach 60% penetration of the new vehicle fleet by 2030²⁸. However there is a large degree of uncertainty over the speed at which they will be rolled out in the nearer term. There is no target for the penetration of EVs in 2020. Government has published a range of independent forecasts which put the penetration of plug-in electric vehicles at between around 2%-12% of new cars in 2020²⁹.

(b) Load profile

Given usage patterns and the availability of cheaper electricity overnight under static time of use tariffs, electric vehicles are likely to be charged overnight.

²⁷ We note that this technology is currently being piloted in Japan.

²⁸ CCC (2010) *The fourth carbon budget*, <http://www.theccc.org.uk/reports/fourth-carbon-budget>

²⁹ DfT (2011), *Making the connection: The plug in vehicle infrastructure strategy* <http://assets.dft.gov.uk/publications/making-the-connection-the-plug-in-vehicle-infrastructure-strategy/plug-in-vehicle-infrastructure-strategy.pdf>

Figure 8 below presents the charge power and duration required for these charge currents, from a single property, assuming a time of use tariff is in place. Daily mileage is based on the analysis in the Technology Strategy Board's Ultra Low Carbon Vehicle Demonstrator (ULCVD) Programme³⁰ was an average of 24 miles for private drivers, requiring a charge window of just over 4 hours. A range of charge currents are possible from 10A (domestic 240V socket), 16A (dedicated charge socket) and 32A (high-rate charge) sockets.

Figure 8. Estimated charge profile - residential

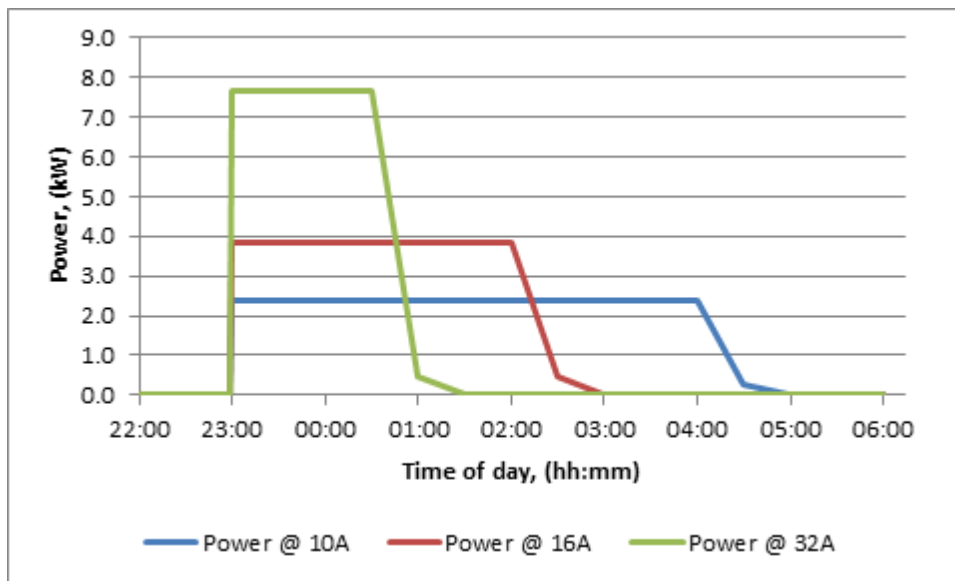

Source: EA Technology

(c) Network Issues and smart grid value

Charging of EVs can be accomplished from standard 240V sockets at 10A³¹ or via a dedicated circuit from a consumer unit at higher rates. The following issues are likely to arise on networks from standard charging:

- **Increase in thermal load:** The main issue for networks arises from the increase in power required to charge electric vehicles. As shown in the diagram above, fast charger could add over 7kW to load. Network issues are compounded if EVs and other new loads such as heat pumps are used at the same time – both could require power at peak times.

³⁰ TSB, Ultra-Low Carbon Vehicles Demonstrator Programme, Initial Findings, 2011

³¹ www.chargemasterplc.com, accessed 03/10/11

- **Voltage profiles:** An additional issue for networks is the potential reduction in volts in areas where domestic electric vehicles charging is clustered. The load and profile of an electric vehicle charging cycle is significant in comparison to conventional After Diversity Maximum Demand of a domestic property, which will increase the volt drop seen on the LV network. Over the longer term, V2G technology could have quite a large impact on the voltage profile at times when balancing power is required and the upper voltage limit could be a concern at times of low network load around clusters.
- **Harmonic levels:** The chargers utilise power electronics, which could impact harmonic levels on the network whilst the charging takes place. Although not a focus of this model, it could become a significant driver for investment into the future. Several projects are in place to truly understand the impact of electric vehicles on network power quality.
- **Connection issues:** There is quite a high likelihood that a proportion of residential EV chargers will be connected without the prior knowledge of a network operator³². It is therefore likely that EV-related loads would be higher than load estimates that have been derived from consideration of connection requests. Network operators will not necessarily learn of car park charging installations in advance as they could use existing connections. If the number of points used significantly increases, then new connections will need to be applied for. If multiple concurrent fast charges at 32kW are required, then an HV connection is likely to be necessary. In this case the DNO would have prior knowledge of installation.

As a result of these network issues, smart grid technologies have the potential to add value in a number of ways to maximise useful capacity:

- by providing more load and voltage information on the network to allow its capacity to be used to the maximum, and allowing DNOs to access these data;
- by configuring the network to manage flows around it as effectively as possible;
- by more actively controlling network voltages; and
- by facilitating demand side response or the use of embedded storage (including V2G) to manage peaks in load.

³² It is noted that the ENA are working with the IET to develop a notification process for domestic consumers akin to that used for the connection of microgeneration under ER G83.

(d) Clustering

In the next decade, due to the high purchase price compared to internal-combustion-driven vehicles, EVs are likely to be purchased by the affluent and those with high disposable incomes. Given the high prices, until the mid-2020s, clustering of EVs is therefore likely in affluent neighbourhoods, either in rural or urban areas, though a fair proportion of the latter may be charged in car parks³³. Exemption from congestion charges, assuming their load grows could mean that affluent suburbs around major cities could also experience EV clusters.

As with heat pumps, such clustering is likely to increase the value of smart grid technologies in locations with high EV load.

Summary of the impact of heat and transport electrification

Table 1 sets out a high level summary of our analysis of the impact of heat and transport electrification on networks, based on the arguments set out above. Further detail on each of these impacts, and how they are likely to vary across urban, rural and suburban networks, is set out in Annexe B.

³³ For example, the purchase price of a Mitsubishi MiEV is around £23k (taking into account the Government's £5k allowance).

Table 1. Summary of the impact of heat and transport electrification

	Likely importance as part of decarbonisation strategy to 2050	Expected level of clustering during rollout	Impact of each unit on thermal profile	Impact of each unit on voltage profile
Residential heat pumps with heat store	High	Low to medium	Low	Low to medium
Residential heat pumps without heat store	High	High	Medium	Low to medium
Commercial heat pumps	High	High	High	Medium
EVs residential charging	High	High	High	Low
EVs residential charging – fast charge	Very uncertain	Uncertain	High	High
EVs residential charging - vehicle to grid	Very uncertain	High	High	Medium
EVs – car park charging	Very uncertain	High	Medium	Low
EVs- car park fast charging	Very uncertain	Uncertain	Medium	Medium
EVs- car park vehicle to grid	Very uncertain	Uncertain	Medium	High

3.1.3 Increase in distributed generation

In addition to the electrification of transport and heating, the growth of renewable generation that is directly connected to the distribution network (“distributed generation”) may also help the UK meet its carbon reduction targets. In recent years, the Government has introduced a number of measures, such as feed-in tariffs for small scale generation, and the Renewables Obligation for large-scale generation, that are designed to promote the use of such renewable technologies.

The growth of distributed generation has the potential to relieve some of the network load pressures associated with the electrification of transport and heating, if located in similar areas and operated at times of high demand. However, the most likely manifestation of the locational coincidence between distributed generation and electrification of heat and transport level is PV generation, heat pumps and EVs. Unfortunately PV will not offset winter early evening peak demands created by EVs and heat pumps, since they will tend to generate most during the day, and in summer. Indeed, as discussed below, the challenge for LV networks will be dealing with summer midday voltage rise and winter evening voltage depression. Therefore, distributed generation is not likely to render smart grids less useful than they otherwise would be.

First, there may be a low degree of co-location, and the coincidence of production and incremental demand may also be low.

Second, distributed generation may drive two further benefits from smart grids:

- **Smart grids could help reduce the need for generation-led thermal reinforcement.** Distributed generation may tend to cluster on certain parts of the network. If so, it is conceivable that there might be some parts of the HV and LV distribution networks where local generation capacity is forecast to grow to the extent that it exceeds local demand at certain times of year. In these situations, it might be the case that local generation growth triggers network reinforcement rather than preventing it. These network pressures may be exacerbated by the fact that much of this distributed generation (e.g. photovoltaics and wind) will be intermittent and inflexible. To the extent that smart grids allow network companies to shift around local demand so that it coincides with local generation peaks, they could help reduce the need for generation-led thermal reinforcement on some parts of the network. Although as discussed in Section 3.1.4, demand side response may also be used to help match demand with the output of intermittent generation.
- **Smart grids could help alleviate other network pressures associated with the increasing penetration of distributed generation.** As we explain below, photovoltaic (PV) installations and the connection of distributed generation will reduce the amount of voltage headroom on

distribution networks, which could in turn require network operators to manage voltage dynamically. To the extent that they allow network companies to shift around local demand load so that it coincides with local generation peaks, smart grids could also help reduce the need for voltage-driven reinforcement on some parts of the network. However, the scope to shift demand to coincide with summer midday peak PV output will be limited.

Having considered at a high level the challenges which distributed generation will create and the ways in which smart grids may help, we now consider the detailed nature of the challenges of each in turn.

We consider the impact of the following distributed generation in this section:

- distributed generation connected to the LV grid: PV and small scale wind; and
- distributed generation connected to the 11kV, 33kV or 132kV network: large-scale onshore wind (at larger and smaller sites), and biomass.

Given the potential benefits of smart grids summarised above in relation to these technologies, in this section we cover the following issues:

- **Overall penetration of technologies:** the extent to which these low-carbon technologies will play an important role in decarbonisation to 2050, and the extent therefore that they are likely to be prevalent.
- **Changes in load profiles:** the impact of these low-carbon technologies on local load profiles, and the impact they will therefore have on the value of DSR.
- **Network issues and smart grid value:** the nature of the impact that rollout of these technologies is likely to have on networks, and hence the added value from smart grid technologies.
- **Clustering of technologies during rollout:** as noted above, the impact on networks will be determined by the clustering of technologies as well its overall penetration on the grid.

Photovoltaics (PV)

PV panels capture energy from the sun and convert it to electricity. In the UK, PV panels are typically mounted on roofs in fixed planes and hence output varies according to the season as well as weather. Whilst techniques can be used to boost output such as by active tracking or concentrating lenses, the simplicity and low maintenance of fixed panels means that they are often preferred.

Value drivers and scenarios

(a) Penetration

PV panels are unlikely to play a central role in decarbonisation in the shorter term, with less than 3 GW expected by 2020, according to Government aims.³⁴

However, while the potential penetration of PV in terms of megawatt-hours may be limited, the potential penetration of PV in terms of number of units installed may be relatively high. In 2010, for example, 53 MW of PV capacity was installed in over 19,000 installations. Given the potential implications of PV units for voltage profiles noted above, this suggests that PV growth could place some pressure on networks going forwards.

Moreover, if the costs of PV falls and performance improves over the longer term, PV could play a large role in decarbonisation³⁵.

(b) Load profiles

The output of a PV panel varies according to the season and weather. Figure 9 below presents profiles of power output for an average 2.8kW system in mid-summer for the conditions clear-sky, average cloudiness (for the time of year) and cloudy conditions. Real output for a typical mid-summer day varies between the maximum clear-sky-output and minimum cloudy-output.

³⁴ DECC (2010) National Renewable Energy Action Plan:

<http://www.decc.gov.uk/assets/decc/what%20we%20do/uk%20energy%20supply/energy%20mix/renewable%20energy/ored/25-nat-ren-energy-action-plan.pdf>

³⁵ CCC (2011) *Renewable Energy Review*, <http://www.theccc.org.uk/reports/renewable-energy-review>

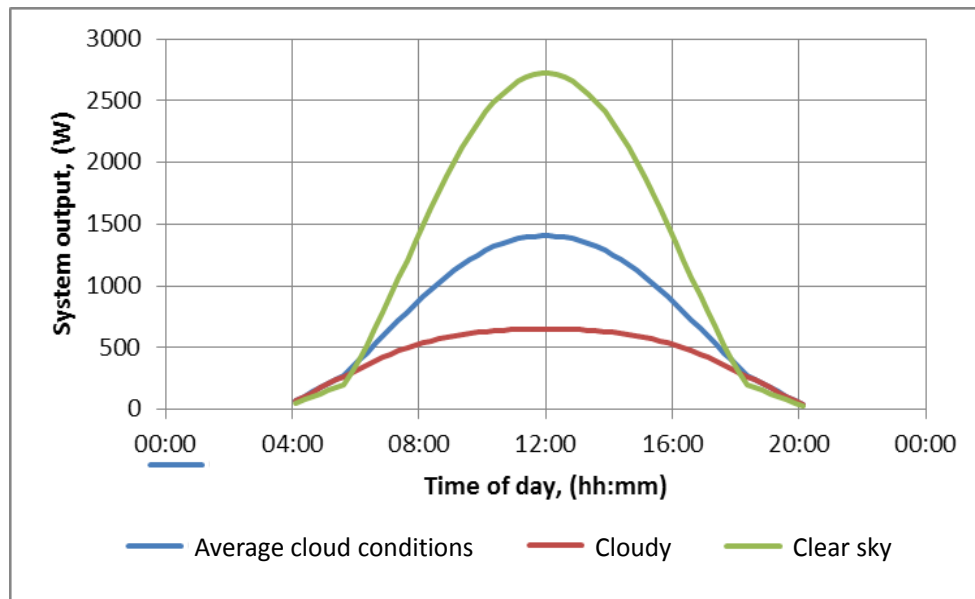
Figure 9. Daily profiles of a 2.8kW PV installation in June³⁶

Source: EA Technology

Maximum generation occurs (for south-facing panels) during the middle of the day, when network loads are relatively low. As noted above, this creates the possibility that some local distribution substations could become generation-heavy with generation exceeding local demand at certain times of day. Because of this, the continued growth in the penetration of PV could place some parts of the distribution networks under pressure. Anecdotally, there are instances of DNOs experiencing power quality and voltage issues, where PV installations are clustered on their networks.

To add to this, the rate of change of output of a single PV installation is in the order of seconds as clouds pass overhead. In this regard, growth in PV penetration could, potentially, increase the utility of smart grid technologies to the extent that they help networks to shift around local demand at short notice to respond to these intermittent generation flows.

(c) Network issues and smart grid value

The following network issues are likely to arise with the increasing penetration of PV units in the UK.

³⁶ Photovoltaic Geographical Information System daily output for a 2.8kW system located around Leeds, UK, available at <http://re.jrc.ec.europa.eu/pvgis/>, accessed 03/10/11

- **Voltage profiles:** PV units will lead to higher voltages on the parts of the network where they connect. With only limited voltage headroom available on many parts of the distribution network, additional PV installations could result in the upper voltage level being reached in many areas. Above this limit, PV inverters have protection settings which will ultimately cause them to switch-off and await ‘normal’ network voltage. Unless DNOs take remedial action, network users will find that their PV systems are not providing the revenue expected. Therefore, to prevent customer complaints arising from nuisance tripping of inverters or equipment damage, DNOs may need to manage network voltages more effectively to create additional headroom.

Such issues may be exacerbated where there are multiple installations. If these are installed by the same entity (e.g. registered social landlords or housing developers), then the network operator can assess the connection and determine consequential actions. If these are as a result of multiple different entities (e.g. left to customer choice), however, then it is possible that network headroom could be breached, without the knowledge of DNOs.

- **Thermal reinforcement pressures:** As outlined above, maximum generation occurs (for south-facing panels) during the middle of the day, when network loads are relatively low. This creates the possibility that some local distribution substations could become generation-heavy with generation exceeding local demand load at certain times of day (e.g. the middle of the day on summer weekdays in mainly residential neighbourhoods). This in turn creates (an albeit very small) possibility that PV growth could trigger thermal reinforcement rather than preventing it on some parts of the network. In practice however, thermal issues from PV penetration are much less likely than voltage issues.

As a result of these network issues, smart grid technologies have the potential to add value in a number of ways to maximise useful capacity by:

- providing more load and voltage information to DNOs on the network to allow its capacity to be used to the maximum in generation dominated areas;
- providing additional voltage control devices to manage network voltages;
- configuring the network to manage flows around it as effectively as possible; and

- facilitating demand side response or use of embedded storage to manage load to match peaks in distributed generation or to manage distributed generation output.

(d) Clustering

Clustering is likely given the visibility of PV systems, with many households installing PV units in response to the visibility of a friend or neighbour's installation. Analysis of Ofgem's Feed-in-Tariff Installation Report³⁷ reveals that 5% of postcodes (defined in the report as the first four digits, e.g. "AB11") collectively contained more than 47% of installations. The maximum number of installations in one postcode was 295, in "S20", with aggregate PV generation of 930 kW.

Small-scale wind power

The small-scale wind turbines considered here range in size from 1 kW to 14 kW. Very small wind turbines designed for mounting on buildings have been termed micro-wind, these were rated 0.4kW – 1.25 kW and were largely shown to have poor performance in trials with an average capacity factor of just 0.85%, and so are not considered here.

(a) Penetration

Small scale wind is likely to remain an expensive option for decarbonisation and is therefore likely to play a smaller role³⁸.

(b) Load profiles

In the UK, there is not a typical daily profile for wind generation, though wind variation does follow certain characteristics. To illustrate this, seven days of estimated power output are presented in Figure 10 with each day's profile being represented by a different coloured line.

³⁷ Ofgem, Feed-in-Tariff Installation Report 30 September 2011 (.xls), available at www.ofgem.gov.uk, accessed 13/10/11

³⁸ The CCC does not include small scale wind as one of key renewable technologies in their review of the contribution of various low-carbon technologies to 2050. See CCC (2011) *Renewable Energy Review*, <http://www.theccc.org.uk/reports/renewable-energy-review>

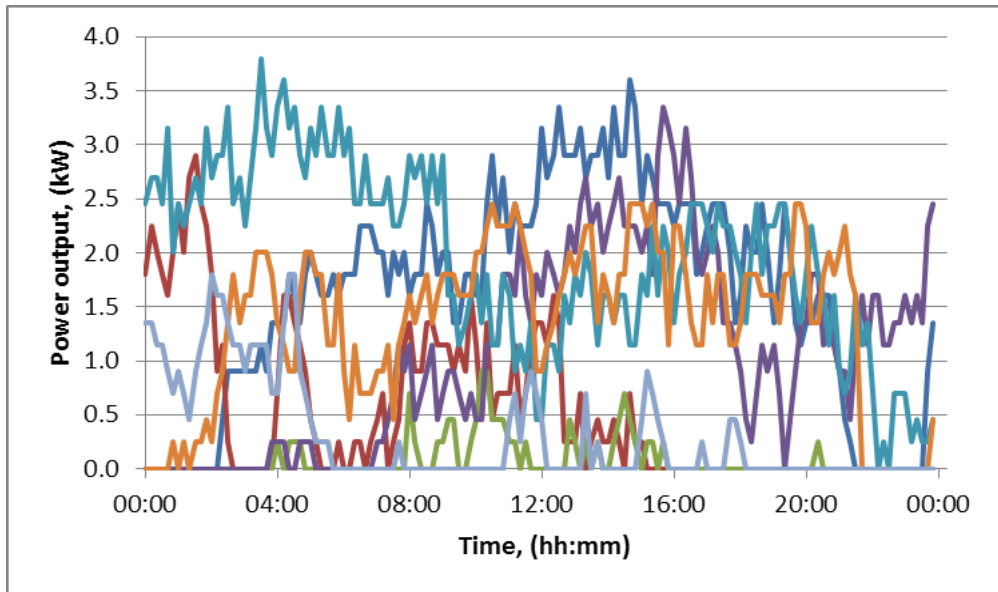
Figure 10. Power output variation for seven April days (Single-site)

Source: EA Technology

(c) Network issues and smart grid value

Issues around wind generation are related to the voltage rise and intermittency of wind generation. Small-scale wind, in the order of 1-10 kW as assessed here, will be LV-connected mainly in rural networks. In these areas, voltage rise from generation can be a concern due to higher system impedance, there is also the potential for flicker to be created. A householder wishing to connect a wind turbine should notify the network operator within 28 days of the connection for those of <16A per-phase. For greater than 16A per-phase, connection requirements must be agreed in advance.

As a result of these network issues, smart grid technologies have the potential to add value in a number of useful ways:

- by providing more load and voltage information on the network in order to allow its capacity to be used to the maximum in generation dominated areas;
- by providing additional voltage control devices to manage network voltages;
- by configuring the network to manage flows around it as effectively as possible; and
- by facilitating demand side response or use of embedded storage to manage load to match peaks in distributed generation.

(d) Clustering

High densities of LV-connected small-scale wind generation are not likely. All wind turbines generate an amount of noise in operation and require free airflow surrounding them for good performance. This limits their application in built-up areas, though we note that more innovative designs may overcome this barrier in the future. In rural areas, the size of local geographical features and ownership boundaries will define the size of clusters. In the near future, due to the capital cost of approximately £25,000 for installation, clustering within ownership boundaries may be quite limited.

Distributed generation connected to the 11kV, 33kV or 132kV networks

In this section we consider distributed generation between 100kW and 100MW, with a connection to either the 11kV, 33kV or 132kV network. The voltage level to which generation is connected will largely depend on the size of the generation, and the ratings of the associated assets at each voltage:

- under 5MW is generally connected at 11kV;
- between 5-20MW is connected at 33kV; and
- above 20MW is normally connected at 132kV.

The exceptions may be where the network is very weak and generators with capacities smaller than these thresholds have to be connected to a higher voltage.

Generation at 11kV or 33kV is generally connected according to Engineering Recommendation G59. At 50MW or above in England and Wales (10MW in north of Scotland and 30MW in the south of Scotland) generators must comply with the more onerous criteria as laid out in the GB Grid Code. These vary according to technology and size but result in much more complex control than installed with smaller generators.

Large-scale onshore wind power

This section considers onshore wind farms with sufficient capacity to connect to 33kV or 132kV networks (e.g. from 5MW to 250MW). Smaller wind sites are covered in the following section.

Most large-scale wind generators are variable speed doubly fed induction generators. Older units can be squirrel cage induction generators that cannot control reactive power, however there are few farms connected to the 33kV network with this technology.

Value drivers and scenarios

(a) Penetration

Wind generation is likely to make a major contribution to decarbonisation, with over 14 GW of onshore wind expected to be on line by 2020, in order to meet Government's 2020 renewable target³⁹.

According to RenewableUK (November 2011) there are 296 operational onshore wind farms with a capacity of over 4 GW. Whilst these figures cover connections to all voltage levels, a significant number are connected to either the 33kV or 132kV networks. In addition over 5GW is consented or under construction. This is expected to continue into the foreseeable future with over 7GW in planning. These figures include wind at smaller sites but this is a small proportion of the total capacity

(b) Load profiles

Wind is stochastic and therefore generation will vary on a continuous basis. The frequency of fluctuations of different length has a defined pattern as indicated by the Van der Hoven spectrum. This demonstrates that there are significant fluctuations due to seasonal variations (winter wind speeds are higher than summer wind speeds in general). There is then a second peak due to diurnal variation (differences between day and night) and a third due to turbulence of the order of 10 minutes or less.

³⁹ DECC (2010) National Renewable Energy Action Plan, <http://www.decc.gov.uk/assets/decc/what%20we%20do/uk%20energy%20supply/energy%20mix/renewable%20energy/ored/25-nat-ren-energy-action-plan.pdf>

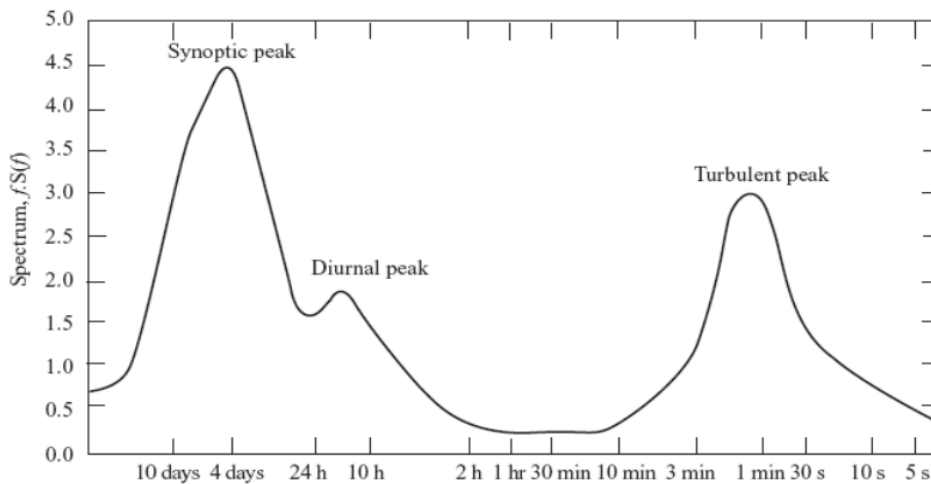
Figure 11. Van der Hoven frequency spectrum of wind speed variation

Source: EA Technology

(c) Network issues and smart grid value

Issues around wind generation are related to the voltage rise and intermittent nature of wind generation.

- Voltage rise is particularly a problem as generators are often sited in areas of weak networks with high impedance.
- The fluctuations in output can cause power quality problems and make matching demand and generation more difficult, although larger wind farms will generally have a smoother output.
- As the wind capacity grows in the UK, there will be a greater need for fault ride through capability (already required under the GB code) so that it can provide more reliable power in network fault conditions. Storage may also be deployed to help manage wind's intermittency.

(d) Clustering

Clustering of wind farms is likely as they locate in areas of high average wind speed, where energy yield is greatest. For GB there is a focus in the north of England, East Anglia, Scotland and Wales, with over 50% of current capacity in Scotland. Turbines are often in rural areas of electrically weak networks and low population.

We assume that this clustering effect will continue along similar patterns for future deployments of large scale onshore wind.

Value drivers and scenarios

Wind power at smaller sites

We are defining small site wind farms and turbines as those which are small enough capacity to connect to the 11kV network (e.g. between 500kW and 5MW). These may be community projects or projects situated by shopping centres or industrial parks, for example.

Community projects are often sited on open ground in rural areas although the locations may be closer to areas of population than large windfarms. Installations near industrial or commercial centres are often closer to centres of population where the wind speeds are lower. Older units and smaller turbines tend to be fixed speed generators. Older units can be squirrel cage induction generators that cannot control reactive power.

(a) Penetration

It is unclear what proportion of the present total wind capacity is from small-site wind. While large-scale wind will tend to be more economic, the drive to meet the Government's 2020 renewable target is likely to involve the deployment of wind at some smaller sites.

(b) Load profiles

Load profiles follow the same pattern as those for large-scale wind, discussed above.

(c) Network issues and smart grid value

Issues around wind generation are related to the voltage rise and intermittent nature of wind generation.

- Voltage rise is particularly a problem as generators are often sited in areas of weak networks with high impedance. Whilst small-site wind may be located closer to centres of population where the network may be more robust, the fact that they are small in size means that additional assets to control voltage can be disproportionately costly. Installation may therefore resort to control measures such as running at a leading power factor to prevent excessive voltage rise.
- The fluctuations in output can cause power quality problems and make matching demand and generation more difficult. Power quality can be more of a problem for small-site wind farms than large farms, as load is situated closer to the generation. Fluctuations in output from small wind farms are greater than large wind farms due to less smoothing because:
 - the spatial separation of the turbines and number of turbines is smaller; and

- each turbine is closer to the ground where turbulence is greater and has a smaller blade diameter.

As the wind capacity grows in the UK, there will be a greater need for fault ride through capability (already required under the GB Grid Code) so that it can provide more reliable power in network fault conditions. Storage may also be deployed to help manage wind's intermittency.

(d) Clustering

The north of England, East Anglia, Scotland and Wales where the wind speeds are highest and therefore obvious areas of focus. However communities and companies across the country do and are likely to continue developing small-site wind.

Biomass generation

Biomass is any form of generation that uses an organic replenishable material as fuel. This could be:

- organic waste;
- agricultural waste;
- waste wood;
- purpose grown wood or biocrops; or
- landfill gas.

Generation can be electricity only or combined heat and power (CHP). Technologies are:

- direct combustion;
- anaerobic digestion (AD) with a gas generator; and
- pyrolysis with a gas generator.

(a) Penetration

The penetration of biomass generation capacity is likely to increase to reach more than 4GW by 2020 from less than 2GW today.⁴⁰

There is a significant number of landfill gas generators in the UK, often using gas from landfill of old quarries or open cast mines. In 2010, there was just over

⁴⁰ DECC (2010) National Renewable Energy Action Plan, <http://www.decc.gov.uk/assets/decc/what%20we%20do/uk%20energy%20supply/energy%20mix/renewable%20energy/ored/25-nat-ren-energy-action-plan.pdf>

1GW of capacity⁴¹. However, efforts to reduce waste going to landfill means that this capacity is likely to decline.

There are 25 domestic waste incinerators located on the outskirts of cities⁴². Smaller plants deal with waste from the food industry and sewage sludge. The sites range from a few megawatts to the largest which is 51MW.

AD has yet to take off in the UK compared to the rest of Europe where it is often used to manage agricultural waste. Some direct incinerators take particular types of waste such as chicken litter.

There are increasing numbers of biomass CHP plants using wood that is too poor quality for timber or purpose grown biocrops. The size is usually limited to a few megawatts as the supply chains for fuel often becomes non-viable above this threshold unless it is on site or domestic waste.

There is currently around 189MW of capacity using sewage sludge, 435MW powered from waste combustion, 139MW using animal biomass and 309MW fuelled from plant biomass⁴³.

(b) Load profiles

Most electricity led generation will be operating at full capacity and have a flat output. Landfill gas will be dependent on the gas from the ground and can fluctuate. CHP may be heat-led and dependent on heat demand. Heat demand tends to be seasonal and mainly during the day, though some heat demand such as that from swimming pools or industrial uses will be more constant.

(c) Network issues and smart grid value

Biomass generation will normally have a relatively flat output similar to conventional power plants and therefore not cause the power quality issues associated with wind.

As with all distributed generation it will cause voltage rise, and as a result, small plant may operate at a low power factor as more sophisticated voltage control mechanisms are economically unviable. As the fuel is controllable, most biomass plants can be scheduled if desired although this may be uneconomic for small plants. The exceptions are those plants that are heat-led or landfill gas where the fuel source is not controlled (unless buffer storage is used).

⁴¹ DECC (2010) *Digest of UK Energy Statistics*, <http://www.decc.gov.uk/en/content/cms/statistics/publications/dukes/dukes.aspx>

⁴² DECC (2010) *Digest of UK Energy Statistics*, <http://www.decc.gov.uk/en/content/cms/statistics/publications/dukes/dukes.aspx>

⁴³ DECC (2010) *Digest of UK Energy Statistics*, <http://www.decc.gov.uk/en/content/cms/statistics/publications/dukes/dukes.aspx>

(d) Clustering

The location of plant will depend on the source of the fuel and heat demand. Given the range of the fuel sources and heat demand, locations can be in urban or rural environments and therefore there is no obvious clustering. If heat networks are developed there may be more plants in urban areas.

The vast majority of units will be connected at 11kV. The exceptions being large energy from waste plants and biomass plants with capacities above 5MW that connect at 33kV.

3.1.4 Increase in inflexible and intermittent generation

This section assesses the extent to which the overall increase in inflexible and intermittent generation is likely to be a value driver for smart grids. Distribution network connected generation was discussed separately in Section 3.1.3.

Decarbonisation of electricity supply will be a crucial part of meeting the carbon budgets and long term targets. For example the Committee on Climate Change estimate that to meet carbon budgets, emissions intensity of generation must fall to around 50gCO₂/kWh by 2030, from around 500 gCO₂/kWh today⁴⁴.

Most low-carbon generation technologies can respond less flexibly to demand than conventional technologies:

- the economics of nuclear rely on it being able to run at very high load factors;
- applying CCS to fossil-fuelled plants may decrease their flexibility; and
- many renewables generate intermittently according to weather patterns and cannot be dispatched on demand.

The decrease in flexibility on the supply side resulting from the deployment of these technologies will increase the value of the flexibility that can be provided by demand side response and storage (as well as other more flexible and controllable generation technologies). However, the required functionality to deliver this demand side response could be delivered using smart meters, without any smart grid investment, since response will not need to be localised to distribution network level. This type of DSR could therefore be accessed by suppliers without investment in smart grids (see Section 4.1.2 for our assumptions on smart meter functionality).

Increasing levels of inflexible and intermittent generation therefore have two main implications for smart grids:

⁴⁴ CCC (2011) The fourth carbon budget, <http://www.theccc.org.uk/reports/fourth-carbon-budget>

- First, supplier-led demand side response (assumed here to be facilitated by smart meters) will have a direct impact on the demand profiles faced by distribution networks. The shifting of demand to optimise suppliers' pre-gate closure positions, or the dispatching of demand for residual balancing will create new distribution network demand profiles. This could result in an increase in the peaks that distribution networks face, thereby driving the value of smart grid solutions.
- Second, for a given volume of controllable load that can be harnessed for DSR, less may be available for smart grid applications (controlling load on individual feeders), depending on the relative value of DSR to networks and suppliers.

3.1.5 Ongoing drive for network efficiency

Smart grids can contribute to network efficiency in the following ways:

- provision of enhanced grid information to optimise voltages and to reduce technical losses; and
- provision of increased grid data to improve reliability, avoid/defer reinforcement capital expenditure, reduce theft and manage risks.

The ongoing drive for network efficiency is likely to be a very important value driver for smart grids. There is little uncertainty that this will remain a goal.

3.1.6 Summary of challenges and smart grid value drivers

Figure 12 summarises the mapping between the demand and supply side challenges described at the outset, and the possible routes for smart grids to add value.

Figure 12. Energy sector challenges and smart grid value drivers

		Source of value from smart grid			
		Provide data on grid	Configure network to manage flows	Facilitate demand side response	Facilitate embedded storage
Electricity sector challenges	Electrification of transport and heating	✓	✓	✓	✓
	Increase in distributed generation	✓	✓	✓	✓
	Ongoing need for network efficiency	✓	✓		
	Increase in inflexible and intermittent generation	No direct impact (managed through smart meters) but impacts the quantity (and hence value) of load which can be controlled by smart grid technologies			

Source: Frontier Economics/EA Technology

As the figure indicates, there are a number of ways in which smart grids can be valuable in addressing the challenges of electrification of heat and transport and an increase in distributed generation.

In relation to network efficiency, the key contribution of smart grids lies in provision of information to the network operator and ability of configuring networks to manage flows.

Finally, the impact of inflexible and intermittent generation is different, assuming the direct impact of this challenge can largely be met by effective use of smart meters. The impact of this challenge on smart grids is therefore largely a function of:

- the impact that supplier-led DSR in response to intermittent generation has on the demand profiles faced by distribution networks; and
- the extent to which supplier-led DSR in response to intermittent generation reduces the volume of controllable load available for DNOs to employ to reduce peaks. If there is a clear constraint, then increased intermittent generation addressed through the use of smart meters will reduce the controllable load available for use by smart grid technologies and hence at the margin decrease the value of those technologies (though also reduce the potential scale at which they are deployed).

Table 2 below provides an indicative high level summary of the technologies that we propose to build into our evaluation framework, based on the analysis set out above. As discussed above, each of these technologies warrants inclusion in our analysis because:

Value drivers and scenarios

- they are likely to become increasingly prevalent in future years (due to their ability to help decarbonise the economy); and
- they are particularly likely to drive smart meter value for one of the following reasons:
 - they will increase peak load for distribution networks,
 - they will increase the complexity of distribution network flows/cause voltage issues; and/or
 - they will impact on the amount of demand that is flexible and can be used for DSR.

Table 2. Value-driving technologies that we propose to include in our evaluation framework

Technology	Prevalence to 2050?	Ways in which the technology may increase the value of smart grids		
		Increase peak thermal load on distribution networks	Cause voltage issues or increase the complexity of distribution network flows	Impact on the amount of demand that is flexible
Electric vehicles	High	✓	✓	✓
Plug-in hybrids	High in the shorter term	✓		✓
Vehicle to grid technology	Uncertain	✓	✓	✓
Heat pumps	High	✓		
Heat pumps with storage	Uncertain	✓		✓
Solar PV	Low to medium		✓	
Small scale wind	Low		✓	
DG: Large scale on-shore wind	High		✓	
DG: Small site wind	High		✓	
DG: Biomass	High		✓	
Large-scale low-carbon plant (nuclear, wind and	High			✓

Value drivers and scenarios

Technology	Prevalence to 2050?	Ways in which the technology may increase the value of smart grids		
		Increase peak thermal load on distribution networks	Cause voltage issues or increase the complexity of distribution network flows	Impact on the amount of demand that is flexible
CCS)				
Distributed large-scale wind, biomass	High	✓	✓	
Technologies which add flexibility on the supply side (bulk storage, interconnection)	Medium			✓

3.2 Scenarios

Given uncertainty over the future, we intend to assess smart grid strategies against up to three scenarios, each of which will represent a different state of the world to 2050.

In this section, we set out the key factors which we intend to vary across scenarios. We then describe our approach to building these scenarios, based on the outputs of SGF WS1.

The key factors to vary across scenarios are:

- the most important smart grid value drivers - those factors which will most affect the value of smart grids in each scenario; and
- those smart grid value drivers around which there is the most uncertainty – i.e. where the level of penetration could vary highly significantly.

Table 3 summarises the importance of value drivers and the level of uncertainty around their future levels, based on the analysis set out in Section 3.1. This suggests that the most important factors to vary across scenarios will be the pace of electrification of heat and transport, since this is both a very important driver of the value of smart grids and highly uncertain. The increase in distributed and

intermittent and inflexible generation should also be varied across scenarios, largely because of its uncertainty. However, there is little uncertainty over the importance of the ongoing drive for network efficiency. We therefore propose that this be held constant across scenarios.

Table 3. Importance and uncertainty over value drivers

	Importance as a value driver	Level of uncertainty over future levels
Electrification of heat and transport	High	High
Increase in distributed generation	Medium	High
Increase in intermittent and inflexible generation	Low	High
Ongoing drive for network efficiency	High	Low

3.2.1 Building scenarios from the outputs of WS1

WS1 of the SGF will develop a set of assumptions and scenarios to 2030 for each of the technologies most likely to have an impact on the value of smart grids. This section sets out how we use these scenarios in our evaluation.

Technology specific scenarios from now until 2030 are being produced for the following technologies for WS1.

- heat pumps - these will be broken into domestic and commercial;
- EVs – these will be broken into pure EVs and plug-in hybrid EVs;
- PV – these will be broken into residential and commercial; and
- distributed wind – this will be broken into residential and commercial.

Scenarios for large-scale generation may be based on the DECC's forthcoming plan to meet the fourth carbon budget, which is due to be published in late 2011, or on other available sources.

We intend to use these scenarios as follows:

- we will base our scenarios on the output of WS1 and DECC's forthcoming plan to meet the fourth carbon budget;
- we will choose the three economy-wide scenarios from DECC's forthcoming plan to meet the fourth carbon budget, that are most different in terms of the extent to which they will impact on the

Value drivers and scenarios

distribution network. We will use the technology specific scenario data that is consistent with these economy-wide scenarios; and

- where the scenarios stop at 2030, we will supplement them with information from the DECC *2050 Pathways* or other sources.

To specify the scenarios at the required level of granularity, further assumptions will be required.

- **Usage patterns of low-carbon technologies:** Assumptions need to be made about the challenges posed by the introduction of new low-carbon technologies (e.g. electric vehicles, heat pumps, PV). We will draw on our experience in this area to make assumptions on:
 - a. the additional load, and typical profiles that will be caused by each low-carbon technology (and noting that this may vary by scenario);
 - b. the technical implications on the electricity system as a whole;
- **Geographic spread and clustering of low-carbon demand and supply side technologies:** Our previous experience of modelling the impact of low-carbon technologies on the distribution network shows that the dispersion of these technologies across different geographic areas, and different network topologies will have a major impact on the costs and benefits of smart grids, particularly to 2020.⁴⁵
- **Geographic spread of network topologies:** We will use the concept of “headroom”⁴⁶ to take account of the different characteristics of networks. We will draw on EA Technology’s estimates of how headroom varies across the current GB networks.

⁴⁵ If clustering is not taken into account then models using the best available estimates of numbers of LCT connected to the network show that there are many years before networks will show capacity problems, whereas some networks already are demonstrating capacity issues, because there is not a uniform distribution of connection of the technologies.

⁴⁶ This was defined earlier in this section and refers to the difference between the actual power flows, voltages and power quality measurements, to limits set by: network design, equipment ratings, or legal / license requirements.

Questions for consultation from Section 3

We would welcome comments on the analysis that we have set out in section 3. In particular:

- Do the technologies set out in Table 2 constitute a sensible list of value drivers?
- Do you agree with our assessment of the technical characteristics of each?
- Are there any other technologies that could have a significant impact on the value of smart grids?
- Our analysis suggests that the most important factors to vary across the scenarios will be:
 - the pace of electrification of heat and transport;
 - the increase in distributed generation; and
 - the increase in intermittent and inflexible generation.

Do you agree? Are there any other variables that we should look to vary across the scenarios and why?

4 Smart grid and conventional investment strategies

A smart grid is not just one technology. It is a range of technologies that can be applied in different combinations and at different geographical scales. There may be interdependencies between the functionality of these technologies, and the costs and benefits of each may differ, depending on whether the technologies are applied in an “incremental” or “top-down” manner.

We propose to account for the interdependencies between smart grid technologies by assessing the costs and benefits of smart grid investment packages or strategies, instead of focussing on the individual technologies and assessing their incremental costs and benefits in isolation.

Our evaluation framework will assess two smart grid investment strategies. These will be compared to a business-as-usual strategy, where only investments in conventional grid technologies are undertaken. Each strategy assessed will entail enough investment to maintain current levels of security of supply and to facilitate the same amount of connections of low-carbon plant and demand side technologies. The strategies will differ solely in terms of the means they use to deliver these outcomes.

Workstream 3 (WS3) of the SGF is currently undertaking a detailed assessment of smart grid technologies. Our evaluation will not duplicate that work. Instead we will analyse a set of representative smart solutions at this stage, and include placeholders in our model based for each of the technology types currently being assessed by WS3.

This section sets out this proposed approach for comment. It describes the business-as-usual case, the smart grid strategies and the technologies that go into making up these strategies.

Our model will allow user flexibility over some of the characteristics of smart grid technologies (e.g. the base year costs, the impact on headroom of each smart technology). In addition, the set of technologies to be included in the model will be expanded once WS3 reports. However, the “strategy” based approach, and our definition of business-as-usual (including some of our assumptions on smart meter functionality) will be fixed.

We therefore particularly welcome comments on:

- our definition of business-as-usual;
- our proposed assumptions on the functionality of smart meters; and
- the smart grid strategies we intend to assess.

4.1 Business-as-usual investment scenario

The business-as-usual case aims to represent the investments that would be made if only smart meters were relied upon, over and above “conventional” grid technologies.

Classifying solutions as “smart” or “conventional” is not always simple. For the purposes of this report, we have classified solutions as conventional if they have been widely used to date. Technologies that have not been widely used to date, even if they have been tested individually and applied in some areas, will be classified as smart.

Because we wish to assess the incremental benefits of the smart grid, the impact of all existing policies will be included in the business-as-usual case. Notably the business-as-usual case will include the rollout of smart meter technology.

In this section, we first describe the conventional technologies that will be included in the business-as-usual case. We then summarise the assumptions that we propose to make about the functionality of smart meters.

4.1.1 Conventional grid technologies

The business-as-usual strategy will encompass the following investment in conventional grid technologies:

- splitting of existing feeders;
- replacement of transformers⁴⁷; and
- installation of new feeders.

Along with these incremental solutions, it is recognised that, in some instances, the only practical option might be the installation of a new substation to provide injection – with potentially significant implementation costs.

Conventional solutions are expected to rise in cost as material prices rise in real terms. Costs may also rise if networks become more complex as it may become

⁴⁷ We do not include changing the fixed tap of a distribution transformer in our list of conventional solutions. Changing the fixed tap of a distribution transformer has limited applicability, only yielding results in a relatively small amount of cases, normally in rural settings. In order to implement such a change, supplies need to be interrupted to customers, making this an unattractive option. It also only permits the changing of one fixed tap to another. This means that, if for example, voltage issues arise due to large amounts of PV during the day (driving the voltage up) and then the effect of heat pumps is felt in the evening (pulling the voltage down), this will not be a suitable solution. Adopting a more “intelligent” solution such as on-load tap changing means that the voltage can be adjusted to cater for both of these scenarios. This is covered under the EAVC smart solution in the document and is likely to alleviate headroom issues for longer than the off load tap changing approach.

more difficult to implement these solutions. Our base costs will be based on those published in the Ofgem DPCR5 Final Proposals.⁴⁸ As a starting assumption, we propose to assume that the costs of conventional technologies will rise by 20% in real terms over the next 40 years. However, our model will be flexible to changes in this assumption.

The conventional solutions included in the model have the following characteristics in common.

- **Capital-intense long-lived assets:** each investment involves significant upfront costs, low operating costs, and has very long lifetimes (with asset lives of at least 40 years).
- **'Lumpy' impact on headroom:** These investments will make a significant rather than a marginal impact on available headroom on the LV feeder – each will approximately double the available capacity.
- **Increasing costs over time:** Conventional solutions are all mature. There is little scope for costs to decline with learning. Instead they are likely to rise as the cost of materials increase.

4.1.2 Assumed smart meter functionality

Smart meters will be included in the business-as-usual case for the smart grid evaluation as Government has already committed to their rollout. Defining smart meter functionality (and describing the resulting data availability, and cost of the data, to different parties in the electricity sector) is therefore extremely important, as our evaluation must only assess the incremental costs and benefits of smart grids over and above the costs and benefits of the smart meter rollout.

This section presents for comment the assumptions on smart meter functionality that we propose to employ in the business-as-usual case.

The consultation on the exact functionality of smart meters is ongoing and the results will not be published in time to inform the development of our model.⁴⁹ We would like our assumptions to represent the most likely eventual functionality of smart meters, and welcome comments on them in that light.

⁴⁸ Electricity Distribution Price Control Review Final Proposals- Allowed revenue- cost assessment appendix. Table 17. Ofgem. Ref: 146a/09. 7 December 2009. Available from:

http://www.ofgem.gov.uk/NETWORKS/ELECDIST/PRICECTRLS/DPCR5/Documents1/FP_3_Cost%20Assesment%20Network%20Investment_appendix.pdf

⁴⁹ http://www.decc.gov.uk/en/content/cms/consultations/cons_smip/

Relevant functionality

There are three aspects of smart meter functionality which will affect the incremental costs and benefits of smart grid technologies:

- functionality that provides greater information and data to networks and suppliers;
- functionality that allows demand patterns to be influenced or changed (i.e. that facilitates DSR); and
- functionality that allows networks to be managed more actively (for example half hourly voltage data could in future be used to trigger distribution transformer automatic voltage control while aggregated half hourly demand data could be used to automatically switch LV network open points between substations⁵⁰).

For the purposes of developing this evaluation framework, the most critical of these relate to the assumptions that we make on the ability of smart meters to facilitate DSR. The assumptions we could make in this area are set out as options below. We welcome comments on the appropriate assumptions to make in our framework.

Smart meter functionality relating to DSR

This section first provides an overview of the three main types of DSR that we consider. The possible “enabling technologies” are then considered (defined in broad terms, rather than the specific technology itself). Finally, we present a number of options as to how these enabling technologies may facilitate different types of DSR.

(a) Types of DSR

We consider three possible types of DSR:

- **Static half-hourly ToU tariffs:** time-of-use tariffs that are set nationally on an infrequent basis (e.g. updated, at most, every month or so);
- **Dynamic half-hourly ToU tariffs set to minimise supply costs:** time-of-use tariffs that suppliers can vary on an hour-by-hour basis; and
- **Dynamic half-hourly ToU tariffs with intervention by DNOs to reduce local peaks:** as above, but DNOs can additionally step in to modify the tariffs (e.g. to respond to local demand conditions).

⁵⁰ Note: a current UK Power Networks IFI/LCNF project is developing an LV automation capability with switchable circuit breakers replacing both substation fuses and solid links in link boxes)

(b) Enabling technologies

We consider the following types of technology that may enable DSR:

- **Smart meters:** Smart meters will be rolled out between now and 2019. This is part of the business-as-usual scenario, and will include some degree of wide area network (WAN) and DataCommsCo (DCC) capabilities.
- **“Enhanced communications infrastructure” for smart meters that do not form part of the smart grid:** It may be the case that the initial WAN/DCC capabilities are not sufficient to enable dynamic TOU tariffs and an additional upgrade in the mid-2020s is required to enable these facilities.
- **Smart grid technologies that can be rolled out on a “top-down” basis to provide additional communication between DNOs and smart meters:** This category includes any investment which occurs across the country to enable some DSR functionality. Unlike the “enhanced communications infrastructure”, this is assumed to be part of the smart grid, not business-as-usual. This could include communications between DNO head-ends and the DCC to enable DNO control of DSR.
- **Smart grid technologies that can be rolled out on a feeder-by-feeder basis to provide additional communication between DNOs and smart meters:** This category includes any DSR-enabling technology that is rolled out by the DNOs on a feeder-by-feeder basis. For example, DNOs might need to implement additional monitoring on substations in order to determine how much half-hourly peak shaving will be required to ensure that demand (on a second-by-second basis) falls within limits.

(c) Assumptions for comment

In this section, we set out a number of different sets of assumptions that the model could make regarding DSR. These assumptions relate to the technologies (above) that would be required to enable different types of DSR.

While we understand that the options presented below are highly simplified and abstract from the detailed functionality of smart meters, they represent the key elements on which we must make assumptions when developing our modeling framework. We would welcome comments on the best option to assume in the analysis.

- In **Option 1** we assume that smart meters alone will allow dynamic supplier-led ToU tariffs. Additional investment by DNOs (which could take place at

either the feeder level or for the whole of GB) is required to allow DNOs to directly influence demand.

- In **Option 2** it is assumed that smart meters alone will only permit static supplier-led tariffs. However, under business-as-usual, enhanced communications infrastructure installed in the mid-2020s will allow supplier-led dynamic DSR. Once this infrastructure is installed, additional smart grid investment by DNOs (whether at the feeder level or countrywide) would be required to allow dynamic DNO-led ToU.
- In **Option 3** we assume that smart meters alone can deliver only static supplier-led tariffs (as in Option 2). However, it is assumed that the enhanced communications infrastructure installed (in the business-as-usual case) in the 2020s could deliver both dynamic supplier-led ToU and dynamic DNO-led ToU, without further DNO investment.
- In **Option 4**, we again assume that smart meters alone will deliver static supplier-led tariffs. In order to enable dynamic time-of-use tariffs (both for suppliers and DNOs), it is assumed that a “top-down”⁵¹ smart grid technology is required.

These options will assign a varying amount of the benefits of DSR to smart grids:

- under Options 1 and 2, smart grids are associated with any benefits that DNO-led dynamic ToU tariffs have over supplier-led dynamic ToU tariffs;
- under Option 3, smart grids do not facilitate any type of DSR. None of the value of DSR will be assigned to smart grids; and
- under Option 4, smart grids will be associated with any benefits that arise from dynamic ToU tariffs (whether supplier- or DNO-led) over and above static ToU tariffs.

Table 4 summarises the assumptions associated with each of these four options.

We would also welcome assumptions on the latency associated with each of these options.

⁵¹ A possibility we do not consider a situation where feeder-by-feeder interventions are required to enable any type of dynamic ToU tariffs. This would seem to be an unlikely requirement, as enabling dynamic ToU tariffs could be done by upgrading pathway between smart meters and the DCC, which would not require DNO intervention. In addition, any feeder-by-feeder intervention which produces large changes in demand profile (in this case, moving from static to dynamic DSR) would likely lead to complex “feedback” in the modelling process. This is discussed in further detail in section 6.

Table 4. Smart meter functionality

	Required for static ToU	Required for dynamic supplier-led ToU	Required for dynamic DNO-led ToU
Option 1	Smart meters alone	Smart meters alone	Smart meters and smart grid investment (either top-down or feeder by feeder)
Option 2	Smart meters alone	Smart meters and smart meter enhanced communication	Smart meters and smart grid investment (either top-down or feeder by feeder)
Option 3	Smart meters alone	Smart meters and smart meter enhanced communication	Smart meters and smart meter enhanced communication
Option 4	Smart meters alone	Smart meters and top-down smart grid investment	Smart meters and top-down smart grid investment

We also propose to assume a half hour latency is associated with smart meter functionality. We would also welcome comments on this assumption.

Smart appliances

Smart appliances are appliances with a built-in capability to respond to signals from smart meters. These might include:

- wet white goods such as washing machines which can be interrupted mid-cycle when required; and
- cold white goods such as fridges or freezers, which could be switched off for short periods of time while maintaining the contents at the required temperature.

The penetration of smart appliances will affect the amount of DSR available as it will affect the ability of customers to respond to price signals.

We intend to assume that the penetration of smart appliances increases over time under business-as-usual, following the rollout of smart meters. This means we will not assess the costs and benefits of smart appliances in this framework.

However we will take account of their impact on the available quantity of DSR. We welcome comments on this approach.

4.2 Smart grid investment strategies

We propose to assess the costs and benefits of two alternative smart grid investment strategies against the business-as-usual case.

Each strategy will maintain current levels of security of supply and facilitate the same amount of connections of low-carbon plant and demand side technologies.

In this section, we first set out the key differences between the approaches to deployment taken by the two strategies. We then describe the characteristics of the technologies associated with each strategy.

4.2.1 Top-down and incremental strategies

It is often argued that the benefits of a smart grid will only be fully realised if a holistic or top-down, rather than an incremental, application of smart grid technologies is undertaken. However, it is also possible that the most cost-effective rollout of smart grids would be on a reactive basis, involving the deployment of technologies when needed.

Given the uncertainty over which strategy might be most suitable, we will test two representative smart grid strategies based on alternative approaches to deploying the individual technologies. The two strategies are as follows:

- **Top-down strategy.** The top-down strategy will test the hypothesis that the benefits of smart grids will be best realised through a holistic and coordinated rollout of smart grid technologies across a DNO region. On some parts of the network, these investments will happen ahead of need. This strategy will be associated with a higher level of upfront costs, with lower costs in later years, once investment has already occurred.
- **Incremental strategy.** The incremental strategy will test the hypothesis that the most cost-effective deployment of smart grid technologies is likely to involve their incremental rollout as needed on each part of a DNO's network. This investment strategy will involve lower upfront costs, with costs instead being incurred on an ongoing basis as the smart technologies are rolled out over time.

Because they involve different cost profiles, these strategies will differ in terms of the flexibility they provide in the face of uncertain future conditions (as discussed in Section 2.3.1).

Smart grid and conventional investment strategies

The conditions under which each approach is likely to be cost effective are described in Table 5.

Table 5. Conditions under which different strategies might be preferable

	Conditions under which <u>top-down strategy</u> is likely to be more cost-effective	Conditions under which <u>incremental strategy</u> is likely to be more cost-effective
Level of uncertainty over future penetration of value driving low-carbon technologies	Less uncertainty	More uncertainty
Diversity of problems faced by different parts of the network	Less diversity	More diversity
Speed of deployment of value driving low-carbon technologies	Faster deployment	Slower deployment
Level of interdependency between the benefits of different technologies	More interdependency	Less interdependency
Economies of scale associated with different technologies	Greater economies of scale	Fewer economies of scale

Source: Frontier Economics

4.2.2 Smart technologies

This section describes the smart technologies that will be included in the smart grid strategies in our evaluation.

Overview of approach

A detailed assessment of smart technologies is currently being undertaken by WS3 of the SGF. This assessment will not be duplicated in our evaluation. Instead, we propose to take the following approach:

- include four representative smart grid technologies in the model; and
- include placeholders for each of the technology types currently being assessed by WS3, so that key technologies can be incorporated into the model once that assessment is complete.

As set out above, while there are a number of possible definitions of smart solutions (as opposed to conventional solutions), we are including all distribution grid solutions which have not yet been widely deployed in the definition of smart technologies. Even technologies which are well understood, and have been

trials are considered to be smart in this framework, since they have not yet been widely deployed⁵².

Similarly, network automation is arguably a conventional network solution, used to manage non-standard network operation in the presence of constraints caused by unplanned circuit outages (faults) or planned circuit outages for network maintenance or improvement work. However, using network automation to manage time varying power flows across the network resulting from new loads and distributed generation is not a conventional solution (there are LCNF projects in progress and proposed to explore the use of automation in this way).

Choice of smart technologies

WS3 of the SGF has defined eleven different smart distribution grid solution sets⁵³. These solution sets are described in Table 6.

Table 6. Smart grid solution sets⁵⁴

Type of solution	Potential response for 2020	Potential responses for 2030
Supply and power quality: Quality of supply, enhancements to existing network architecture	Enhanced Network Observability) Automatic LV reconfiguration to enhance quality of supply - capability at LV substation fuse boards and in link boxes Intelligent switching will require sensing, comms & monitoring including pollution source identification Options to deploy adaptive protection & control techniques Waveform monitoring and waveform correction devices - including: harmonic distortion, sags, surges, and flicker Real Time identification of fault positions for rapid rectification Phase imbalance sensors/correction (improve losses and capacity)	Integration of storage (P/Elec dual functionality for V and PQ Comprehensive waveform quality management Waveform tracking through smart meters or other sensors – including pollution source identification Location of fault positions for more rapid rectification Optimise national losses/carbon across multiple voltages and companies Use sensors to track, pinpoint and respond to high losses events.

⁵² An example of such an intervention would be managing local voltage excursions by changing the fixed tap of the local distribution transformer then varying the voltage set point of the primary voltage control scheme.

⁵³ We are excluding smart transmission networks enhancements, which are included in the workstream 3 solution set paper.

⁵⁴ Smart Grid Workstream 3, Forthcoming, *Developing Networks for Low Carbon*

<p>Active management: DG connections, management of 2-way power flows</p>	<p>Intelligent voltage control to manage 2-way power flows Fault Limiter devices to control short circuit currents Adaptive protection mechanisms Sensors and State Estimation for observability of flows/voltages Consumer volts measurement from smart meters or other sensors Data communications close to real time</p>	<p>Utilise storage at domestic, substation and community level LV and MV phase shifters to direct power flows Deployment of PMU sensors for dynamic stability monitoring DR services aggregated for LV & MV network management Forecasting & modelling tools for DNOs Integration between DNO/DNO/TSO for data and information</p>
<p>Intelligent assets: Plant & systems reliability, failure mode detection</p>	<p>Dynamic Ratings for all plant types and multi-element circuits Condition Monitoring for ageing assets - failure advance warnings for lines, cables, transformer and switchgear Status Monitoring for intelligent control systems - pre failure alerts Use of advanced materials to increase ratings of overhead lines Use of novel tower/insulation structures to enhance route capacity</p>	<p>Diagnostic tools for managing intelligent control Re-commissioning tools and techniques for extending/scaling systems intelligent control systems Loss minimisation Fault localisation and diagnostic techniques</p>
<p>Security and resilience: Security of networks including physical threats, utilising new network architecture</p>	<p>Enhanced supply reliability by automatic network reconfiguration Use of meshed rather than radial architectures Greater use of interconnections & higher voltage system parallels Utilisation of 'last gasp' signals from smart meters and sensors - integrate data with SCADA systems and higher voltage levels Forecasting & modelling tools for DNOs to manage new demands Cyber & Data Security protection for network communications</p>	<p>Self-healing network diagnostics and responses Self-restoration and resynchronisation of islands Synthetic inertia devices to support dynamic stability Utilise storage for domestic, substation, community security EVs as network security support (V2G) Advanced network topology management tools for DNOs DC networks (eg home / community) integrated with AC system Self-islanding opens opportunities for new security/investment policies</p>

Smart EV charging: EV charging/discharging, network management, demand response and other services	Open Systems with standardised communication protocols and standardised functionality for EVs/Charging Points Architecture - distributed processing - street, substation or community level, distributed charging management, with aggregated reporting and supervision for reliability Commercial frameworks required	Integration of local storage to support charging capability Demand Response aggregated services (downward/upward) Aggregated V2G services Forecasting and modelling, integrated for DNO/DNO/TSO Standardised functionality available for rapid wider roll-out
Smart storage: electricity storage at domestic, LV and MV levels and above (static storage devices)	Domestic, street, community and regional facilities Storage monitoring and tracking of energy status and availability Storage management & control to enhance network utilisation Tools for optimising location of storage on networks Optimised charging/discharging to extend life of storage medium Basic commercial frameworks required, particularly for merchant energy storage services	Seasonal and diurnal storage charge/discharge management Integration of storage management across the power system Standardised functionality available for rapid wider roll-out Storage management used to minimise overall system losses Deployment of multiple storage types, optimally integrated Full commercial frameworks likely to be required
Smart community energy : Geographic and social communities in existing built environment	Enhance network performance by forging closer links with those it serves Build a local sense of energy identity, ownership, and engagement Integrate Community Energy with Government's Localism agenda Develop a Technical, Commercial, and Social functionality set Energy from Waste and centralised CHP integration Trading of energy and services within local communities	Demand Response optimised with a Community group Exported domestic generation traded within group Standardised functionality available for rapid wider roll-out Vibrant 'energy engagement' that maintains interest & participation Trading of energy and services between local communities
Smart buildings and connected communities: SME C&I buildings and all aspects of new built environments	Building management systems with standard functional interfaces Buildings provide DR services and DG services Buildings provide energy storage (heat/elec) services Private networks in similar roles	Buildings and groups of buildings providing integrated services Communities managing their energy, integrated with networks Buildings with self-islanding and re-sync capability Private networks in similar roles

Smart grid and conventional investment strategies

Smart ancillary services (local and national): ancillary services for the local and national system	Aggregation of domestic DR (downward response) Aggregation of EV charging (variable rate of charging) Commercial frameworks Aggregation of DG (eg PV) to provide Virtual Power Plant (VPP) capabilities	Aggregation of domestic DR (downward/upward responses) Aggregation of EV charging (variable charging/discharging) DSOs manage local networks, offering integrated services to TSO National VPP capabilities. Responsive demand, storage and dispatchable DG for wider balancing include post gate-closure balancing and supplier imbalance hedge New tools are increasing relevant as gen. reaches government targets
Advanced control centres: T&D control centres of the future	Visualisation and decision support tools Data processing at lowest levels, information passed upwards Modelling & Forecasting tools for new demands, in Ops timescales	GB system view, integrating TSO and DNO network management Whole GB system carbon optimisation (config., losses, storage) Architectures and Systems platforms that support hybrid combinations of distributed/centralised applications
Enterprise-wide solution: enterprise wide platforms within companies	Facilities that provide cost-effective outcomes, across Solution Sets This may apply to Enterprise-wide communications, data storage etc	Integration of Enterprise-wide solutions with dispersed niche provisions Flexibility to ensure that Enterprise-wide solutions do not constrain solutions to challenges not yet envisaged

Once the WS3 analysis has been undertaken, more detailed information will be available on the cost and functionality of a wide range of smart grid technologies. In the meantime, we propose to include four representative technologies in the model. These will illustrate how the model represents the costs and benefits of alternative solutions under different conditions. They will not be used to give a definitive answer on the net benefit of a “smart grid”

Solutions covered in this document are:

- battery electrical energy storage (e.g; flow-cell, Li-Ion, Sodium Sulphur);
- dynamic thermal ratings;
 - overhead lines;

- underground cables;
- transformers;
- enhanced automatic voltage control; and
- technologies to facilitate DNO-led DSR.

We have chosen these to be our ‘representative’ technologies because, as Table 7 below illustrates, they collectively encompass what we understand to be the main services that smart grids can provide, namely:

- the provision of data on the distribution networks;
- assistance in optimising network power flows;
- the facilitation of DNO-led DSR; and
- the provision of embedded storage.

More detailed descriptions of each smart grid technology are provided in Annexe C.

Table 7. Summary of functionalities provided by key smart grid technologies

Smart grid technology	Provision of data on the grid?	Optimise network power flows	Facilitation of DNO-led demand side response?	Provision of embedded storage?
Electrical Energy Storage		✓	✓	✓
Dynamic Thermal Ratings	✓	✓		
Enhanced Automatic Voltage Control	✓	✓		
Technologies to facilitate demand side response	✓		✓	
Dynamic Network Reconfiguration	✓	✓		

Source: Frontier Economics

We now provide an overview of each of the first four representative technologies. Specifically, we provide:

- a description of the technology;
- an overview of the likely impact of the technology on headroom;
- an overview of the technology's lifetime and lead time; and
- a description of the technology's likely cost profile.

In this report we do not provide any detail on methods surrounding dynamic network reconfiguration, which will primarily deliver thermal headroom benefits to the higher voltage levels and can help facilitate the connection of DG. However, we are planning to consider this in the next phase of our work and fully anticipate that such techniques will feature within the network model.

Electrical energy storage (EES)

(a) Description of technology

EES technology offers an alternative to conventional reinforcement where networks are constrained by the requirement to deliver peak power for only a few hours in a day or year. EES can deliver the peak required, being charged overnight or in other periods of low demand, thus avoiding lengthy or costly network upgrades. Many EES technologies are, however, currently expensive (up to £3000/kW, depending on quality), involve energy losses (typically 75% efficient). Further, their performance degrades over time and with each discharge. They have a shorter calendar life than conventional assets.

EES and flow batteries are considered here. We are focussing on these technologies as:

- they can deliver in the 2-4hr discharge duration that is necessary for peak lopping;
- they can be stacked together to produce capacities large enough to cater for network operator requirements; and
- they do not require any specific geographical or geological features (unlike for example, hydro based pump storage).

All EES and flow battery technology require grid connection via Power Conversion Systems (PCS). These are worthy of note as well-developed PCS are able to provide the capability to deliver or absorb reactive power to improve power factor (reduce losses), provide voltage control and act as a sink for harmonic currents (to improve voltage quality).

EES can be called upon to adjust any existing demand profile to bring it above/below network constraints. Note that to ensure longevity of the solution, the number of charge/discharge cycles should be minimised, for example limited to one charge cycle per night and one discharge cycle at peak times.

(b) Headroom released

Each kW of storage invested in would release one kW of thermal headroom. At a constant 1% growth in load, this would provide 6 years of load-growth-deferral for an 800 kVA transformer.

In terms of LV voltage headroom, EES would typically be used to flatten peaks created by generation (e.g. high volts resulting from PV in the middle of the day) or load (e.g. low volts resulting from EVs at the early evening peak)⁵⁵.

(c) Lifetime and leadtimes

⁵⁵ Given an 800 kVA transformer of 5% impedance, a voltage of 12V is developed on 240V at full load (5%*240V). A 50 kW EES device would reduce power through the transformer *in both directions*, effectively creating a control range of $2 \times (50\text{kW} / 800\text{kW}) \times 5\% \times 240\text{V} = 1.5 \text{ V}$.

EES asset life is electrochemically limited by the number of charge/discharge cycles that the technology can sustain without severe performance degradation. The chemicals used in flow-cell batteries are highly reactive; with every cycle the chemically active parts pollute to some degree, such that over the course of time, performance suffers. In this respect, flow cells offer the greatest potential for longevity as the active parts can be replaced or refreshed to renew performance. As life depends on cycles, limiting the number of cycles necessary to provide upgrade deferment by a form of intelligent control may be necessary. Considering daily cycles used for peak lopping over one-quarter of a year, the various technologies would have calendar lives (determined from cycle numbers per year) of up to 15 years for lead-acid and up to 30 years for sodium metal-halide.

In 2011, EES units are not readily available off-the-shelf, with typical lead-times of 6-18 months. This is about equivalent to the amount of time that should be allocated for pre-installation project and site preparation, fire, operation and safety procedures. Deployment requires suitable space to be available, which can increase costs, particularly in congested urban and suburban substations. Compared to reinforcement (e.g. the construction of new overhead lines or substations), planning processes should be reduced. Most types of EES could be relocated or expanded in a modular manner as the need to peak lop changes over time. Given the interest in EES and the relatively limited supply capacity for utility-scale applications, availability will be subject to global markets.

(d) Cost profiles

In the absence of any firm evidence on the future evolution of storage costs, we propose to assume that the costs of storage will decline to 2020 and stabilise thereafter. The cost of land to locate the storage needs also to be captured, as this could be significant, particularly for urban areas.

All of the assumptions on costs will be flexible in our framework, and can be improved as more experience in deploying these technologies is gained.

Dynamic thermal rating

(a) Description of technology

Dynamic thermal ratings (or real time thermal ratings) refers to techniques by which the maximum capacity of various network components can be assessed in real time in response to local environmental conditions, such as temperature.

The focus of applications of dynamic ratings in the UK to date has been on overhead lines, primarily to facilitate more wind farm connections without costly reinforcement. However, dynamic thermal ratings can also be applied to underground cables and transformers.

(b) Headroom released

Headroom can be released either by increasing the use that can be made of the asset for cables or by increasing use, or extending the life, of transformers. The impact on headroom is likely to be as follows:

- **Overhead lines:** The amount of thermal headroom that can be released depends on the topography of the network and the surrounding area. For example, lines across open fields can have their rating increased more than those running through wooded areas. The amount by which the rating is increased also depends on the speed of response of any associated demand or generation control. However, for a line across open ground an increase in rating of up to 30% can be expected.^{56,57,58}
- **Underground cables:** At present this is not well-defined, but it is envisaged that ratings could be enhanced by up to 10% depending on the difference between the actual load profile and the profile of Engineering Recommendation P17 – ‘Load Curve G’ (Loss Load Factor = 5.061). It should be noted that the rating enhancement for underground cables is likely to be considerably less than that available via applying dynamic ratings to overhead lines. This will again be dependent to a degree on the speed of any available demand or generation control on the network.
- **Transformers:** The amount of headroom released depends on the control strategy implemented and whether the purpose of the dynamic thermal rating is primarily to reduce ageing or increase ratings. Additional capacity of 10-20% is claimed by manufacturers but few applications have yet published data. Recent studies indicate that distribution transformers are possibly the most highly stressed part of the LV network. If the scheme is installed in tandem with some DSR, the headroom release will also depend on the speed of response of load or generation control, i.e. how quickly demand could be reduced if necessary will govern how far the asset can be stressed above its nominal rating.

(c) Lifetime and leadtimes

At present, asset life is something of an unknown. The equipment is designed to act in a “fit and forget” manner without the requirement for ongoing maintenance.

We intend to make the following assumptions:

⁵⁶ T. Yip et al, (200) *Dynamic Line Rating Protection For Wind Farm Connections*, CIRED

⁵⁷ H. J. Drager, D. Hussels & R. Puffer, (2008) *Development and Implementation of a Monitoring System to Increase the Capacity of Overhead Lines*, CIGRE

⁵⁸ CIGRE Study Committee 23, (2002) *Dynamic Loading of Transmission Equipment*,

- the life of the equipment for overhead line dynamic thermal ratings solutions (i.e. “power donuts”, current transformers etc.) would be of the order of 15 years;
- for primary transformers the asset life should be matched to that of the transformer. We will base this on the outcome of Ofgem’s recent decision on the economic lives of network assets⁵⁹; and
- for secondary transformers, there is less to base assumptions on, but if oil tank temperature probes are to be used, an asset life of 20 years seems a reasonable assumption.

Though physically installing these dynamic thermal rating solutions is likely to take less than six months, the lead times for the newer solutions such as underground cables and transformers are likely to be longer due to the need to demonstrate compliance with relevant equipment standards. Dynamic thermal rating for underground cables would also need to be trialled before large scale rollout. Lead times for application of these solutions are thus likely to be longer than the conventional alternatives.

(d) Cost profiles

The costs of dynamic thermal rating are likely to decline as the technology becomes more mature. For the purposes of our modelling, we proposed to assume a modest reduction of around 10% over the next decade. However, this assumption will be flexible in the modelling.

Enhanced Automatic Voltage Control

(a) Description of technology

Network voltages must be maintained within strict statutory limits, as set out in Electricity Quality And Continuity Regulations 2002 (as amended). Manufacturers of equipment which connects to the network are obliged by this Directive to design and build products that can safely operate at any voltage within the specified limits. An ‘Enhanced Automatic Voltage Control’ (EAVC) system consists of a range of devices that can help a DNO to keep network voltages within certain limits in the context of increased voltage-control challenges thrown up by new network developments.

Conventional DNO design assumes networks to be passive with unidirectional power flows. In this context, so-called Automatic Voltage Control (AVC) schemes acting upon the grid and primary transformers⁶⁰ are configured to work

⁵⁹ <http://www.ofgem.gov.uk/Pages/MoreInformation.aspx?docid=332&refer=Networks/Policy>

⁶⁰ The Grid and Primary transformers are those that operate at 132/33kV and 33/11kV and similar voltages.

autonomously. However, the increasing penetration of various low-carbon technologies is likely to give rise to voltage changes that AVC schemes will struggle to manage. Moreover, the addition of certain smart solutions such as electrical energy storage, dynamic thermal ratings and demand-side response, form additional subsystems within the network, which will need to work in concert with the voltage control devices. This will create further pressure on existing AVC schemes.

As the network starts to operate closer to these limits, however, DNOs may opt to introduce additional automatic voltage control devices over and above those located at the grid and primary transformers. Together these new and existing voltage control devices will constitute an EAVC system. Depending on specific network circumstances, investing in an EAVC system may prove a cost-effective alternative to conventional network reinforcement as a means of circumventing the problems associated with voltage control.

Examples of EAVC solutions include:

- primary transformer (EHV/HV) solutions, e.g. modified control solutions to the conventional AVC relay, taking additional voltage sensing input from points on the network;
- in-line voltage regulators for HV circuits;
- HV switched capacitor banks;
- on-load tap-changers and/or LV regulators for distribution transformers (HV/LV); and
- three-phase or single-phase voltage regulators for LV circuits.

(b) Headroom released

The level of headroom to be released by EAVC solutions will vary, depending on the control system. It is likely that a target voltage will be set and the EAVC will operate so as to achieve this voltage. To some extent, therefore, the headroom released will be dependent on the severity of the voltage issue that the network is experiencing.

The EAVC solutions are not designed to release thermal headroom. Any thermal headroom that is released as a by-product of EAVC solutions would be negligible.

(c) Lifetime and leadtimes

At present, the asset life of the various EAVC solutions is unclear. However, they are primarily “fit and forget” maintenance-free devices that would be designed to have asset life coincident with that of the plant with which they are associated. Therefore, a reasonable assumption for the current carrying assets would be that all of the solutions named above have an asset life of 40 years, with

the possible exception of the HV Switched Capacitor Bank, which may be slightly shorter and is assumed here to be 30 years. It is recognised that the assets used to protect and control the current carrying equipment will have a shorter life of c 20 years.

The indicative lead times for the equipment of each solution are as follows:

- primary EAVC control only (not the transformer or on load tap-changer) – 2 to 4 months;
- HV in-line voltage regulator – 4 to 5 months;
- HV switched capacitor bank – A brick built switching station with two switched capacitor banks – 12 to 18 months, though this will be dependent on planning timescales;
- HV/LV distribution transformer EAVC;
 - Distribution Transformer with on load tap-changer – 6 – 12 months;
 - LV voltage regulator – 2 to 3 months;
- LV regulator on LV circuit:
 - Single consumer single-phase regulator – 1 to 2 months; and
 - Three-phase regulator installed on LV circuit at a substation or pre-installed kiosk – 2 to 3 months,

Our analysis makes use of the midpoint of these lead-time ranges for each technology

(d) Cost profiles

The following are indicative prices of EAVC equipment for the solutions listed above:

- Primary EAVC control only (not the transformer or on load tap-changer) – £30k to £50k;
- HV in-line voltage regulator – £50k to £60k;
- HV switched capacitor bank – A brick built switching station with two switched capacitor banks – £465k;
- HV/LV distribution transformer EAVC;
 - Distribution Transformer with on load tap-changer – £15k to £125k;
 - LV voltage regulator – £5k to £10k;
- LV regulator on LV circuit;

- A single consumer single phase regulator – £2k;
- Three phase regulator installed on LV circuit at a substation or pre-installed kiosk – £20k;

The costs of EAVC are likely to decline as the technology becomes more mature. For the purposes of our modelling, we propose to assume a modest reduction of round 5% over the next decade.

Technologies to facilitate DNO-led demand side response

Demand side management (DSM) refers to any measure that results in customers making changes to the amount of energy used, the primary source of that energy or the pattern of consumption. Demand side response (DSR) relates specifically to measures that impact on the pattern of consumption. Although measures can result in permanent changes to the pattern of consumption, the DSR usually relates to short-term, discrete changes and only these measures are considered here.

DSR measures can take a number of forms:

- they can be supplier-led, system operator led or network-led; and
- they can take the form of price signals, measures that allow third parties to control demand load directly and/or measures that control demand load place automatically in response to changes on the electricity network.

In the case of DSR price signals, measures can take the form of static time-of-use price signals (tariffs that vary according to the time of day in order to discourage demand load at peak times) or dynamic time-of-use price signals (tariffs that vary in response to real-time demand information in order to discourage demand load at peak times).

In Section 4.1.2, we set out a range of options for assumptions on the technologies required to facilitate DSR. These technologies will include:

- electricity meters with smart functionality;
- an in-home display (IHD) for domestic customers;
- a wide area network (WAN) communications module to connect to the central communications provider; and
- a home area network (HAN) to link different meters within customer premises, the communications module and the IHD (and potentially other consumer devices, such as microgeneration and load control devices).

DNO-led dynamic time-of-use tariffs may also require the following technologies to be rolled out:

Smart grid and conventional investment strategies

- sensing information on the network to trigger the DSR events; and
- an interface from the DNOs control architecture to the DSR head-end (either via a supplier, the DCC, or directly to the customer) to enact the DSR event.

Summary of key characteristics of smart grid technologies

The key differences between the smart technologies described above and the “conventional” network technologies described in Section 4.1.1 can be summarised as follows:

- **Shorter-lived assets:** While conventional assets have lifetimes of at least 40 years, these investments have lifetimes ranging from 10 years.
- **Less ‘lumpy’ impact on headroom:** These investments will generally make a less significant impact on available headroom on the LV feeder than conventional assets.
- **Longer lead times:** Though physically installing these assets is likely to take no longer than their conventional alternatives, some of the technologies described here have never been trialled (e.g. dynamic thermal rating for underground cables). Others (e.g. dynamic thermal rating for cables and transformers) may need to demonstrate compliance with relevant equipment or operational standards which will add to the initial lead time for early adopters. Smart technologies may therefore sometimes involve longer lead times than their conventional alternatives.
- **Declining costs over time:** Because smart technologies are mostly less mature than their conventional alternatives, their costs are likely to fall over time.

Questions for consultation from section 4

We would welcome comments on the analysis that we have set out in Section 4. In particular:

- Out of the options presented, which set of assumptions should we make on smart meter functionality?
- Do you agree with our proposed approach of including smart appliances in the business as usual?
- Do our proposed smart grid strategies capture the main deployment options?
- Have we provided an accurate overview of the main services that smart grid technologies can provide?
- Do you agree with our proposed assumptions on the characteristics of these technologies?

5 Value chain analysis

It is important that our evaluation framework takes account of how the costs and benefits of smart grids are distributed across different parties in the electricity sector.

If costs and benefits of smart grids are not aligned between different parties, this may act as a barrier to smart grid deployment. This would be the case if high transaction costs prevent individual parties contracting to apportion costs and benefits between each other, or if the incentive regime does not appropriately reward companies for doing this. The existence of these kinds of barriers drove the rationale for mandating the smart meter rollout.

An important part of this evaluation exercise is therefore to understand more about how distribution network investment in smart grids may create costs and benefits that are borne elsewhere in the energy supply chain, as well as broader costs and benefits to society as a whole. This is likely to be an important input into the consideration of smart grid investment cases in RIIO-ED1.

However, while we do need to understand the spread of costs and benefit across the value chain, we are not carrying out a detailed distributional analysis, of the type produced in Impact Assessments. In particular:

- this section does not assess the distributional impact on different customer types; and
- we do not propose to analyse how market mechanisms (such as price controls) will assign value to different groups within the electricity sector.

This section sets out how we intend to consider the following groups in our evaluation:

- DNOs;
- transmission network operators (TNOs);
- suppliers/generators; and
- customers.

While our evaluation framework will also consider the net benefit to society as a whole, in this section we focus on our proposed approach to assessing the spread of costs and benefits among the four electricity sector parties listed above.

A key factor underlying this analysis will be the assumptions we make on smart meter functionality. In this section we make the assumption that:

- dynamic supplier-led DSR is possible using smart meters alone; and

- smart grids are required to deliver DNO-led DSR.

We will review this value chain analysis if our assumptions on smart meter functionality change following the consultation.

In many cases, the eventual distribution of costs will depend on the market arrangements in place. We do not comment on these market arrangements here, rather we simply set out on whom the costs and benefit of smart grids would initially fall, and where they could be expected to be passed through, given assumptions on benefit sharing, which will be kept transparent and flexible in the model.

We first consider which parties will bear the costs of smart grid investment, and then provide our assessment of the beneficiaries.

5.1 Distribution of smart grid investment costs

In Section 4 above we set out each of the smart grid investment options that our analysis will consider.

All of these options relate to technologies and practices that would be rolled out across the electricity distribution networks. This means that, in the absence of any direct public subsidy for such technologies and practices, the costs associated with their introduction would be directly borne by DNOs.

The DNOs may be able to pass on their costs to electricity customers in the form of Distribution Use of System charges, depending on the arrangements adopted by Ofgem as part of the price control process. We are not proposing to analyse options for these arrangements, but will make simple transparent assumptions on cost pass through, which can be flexed in the model.

5.2 Distribution of smart grid benefits

As detailed in Section 3 above, we are considering that smart grids will deliver the following services:

- provide data on the distribution grid;
- optimise network power flows;
- facilitate DNO-led demand side response; and
- provide embedded storage.

We consider how each of the groups we are assessing would benefit from these services in turn.

Value chain analysis

5.2.1 DNOs

DNOs stand to benefit from the following smart grid services:

- **The provision of additional data on the distribution grid.** Additional real-time information about the performance of network assets and more load and voltage information on the network can allow DNOs to use their network capacity to the maximum. This may allow them to avoid or defer reinforcement expenditure, without undermining the security of network supply.
- **Optimising network power flows.** Managing flows effectively around the network can allow DNOs to avoid or defer reinforcement expenditure.
- **DNO-led DSR:** DNOs stand to benefit from DNO-led DSR, as it is likely to be harnessed to allow them to reduce peak demand and thereby defer or avoid reinforcement.
- **Embedded storage:** DNOs stand to directly benefit from embedded storage, as it is likely to be harnessed to allow them to reduce peak demand and thereby defer or avoid reinforcement.

5.2.2 Transmission network

Our evaluation framework is assessing the application of smart technologies at distribution network level only. These smart technologies could potentially also have beneficial implications for the GB transmission network. In particular:

- a smart grid could in principle help National Grid to balance demand and supply on the system, to the extent that it facilitates DSR with a shorter latency period than the business-as-usual solutions; and
- to the extent that it facilitates DSR, a smart grid could flatten the GB-wide demand profile, thereby potentially alleviating transmission network congestion and reinforcement costs.

We set out how we propose to use our evaluation framework to measure each of these potential benefits in turn.

Balancing supply and demand on the system

In its capacity as Transmission System Operator, National Grid is responsible for keeping the electricity system in balance at any given time. National Grid has recourse to a number of instruments to help it balance demand and supply, including Short Term Operating Reserve (STOR). STOR is a contracted reserve service for the provision of additional active power from generation and/or demand reduction. STOR units, which are procured through a competitive

tendering process, are paid to be available within 20 minutes; any utilisation then requires additional payments.

A number of developments are likely to place additional pressure on the balancing regime over the next decade. In particular, because of the growing penetration of wind power, generation output will increasingly reflect unpredictable real-time changes in prevailing weather conditions. Other things being equal, this is likely to increase the amount of STOR that National Grid needs to procure in order to keep the system in balance.

To the extent that it facilitates DSR with a shorter latency period, a smart grid could, in principle, help National Grid to handle these increased balancing pressures without procuring as much generation capacity for STOR as would otherwise be required.

To estimate the effect that smart grids could have on balancing costs, we propose to adopt the following three-step methodology.

- ***Identify the current annual cost of using STOR to balance demand and supply.*** The reserve generation capacity that is procured for STOR has an opportunity cost, since this capacity could in principle be utilised for non-balancing purposes. This opportunity cost should be reflected in the value for which that capacity is procured for STOR. We therefore propose to use the total level of procurement expenditure on STOR per MW of capacity and per MWh of utilisation in recent years to estimate the current opportunity cost of using STOR to balance short-term demand and supply.
- ***Estimate how the cost of relying on STOR is likely to develop between 2012 and 2050 in the absence of smart-grid-enabled DSR.*** In future years, the total cost of STOR could be affected by both changes in the amount of STOR that needs to be procured and changes in the cost of procuring a unit of STOR. The projected growth in the penetration of intermittent wind generation makes it likely that National Grid will need to procure more STOR than it currently does for balancing purposes. At the same time, however, the number of part-loaded plants on the network is likely to increase, which could reduce the unit cost of procuring generation capacity for STOR. Our analysis would need to take account of both of these potential developments.
- ***Estimate the extent to which smart-grid-enabled DSR could help meet these projected STOR requirements.*** This depends on the scope for DSR in the absence of smart grids. If smart meters (along with any enabling technologies that form part of the business-as-usual investment strategies) can themselves facilitate short term DSR, then the incremental balancing benefits associated with smart grids may be limited. Even if smart grids are capable of reducing the DSR latency period below 30 minutes, the

Value chain analysis

incremental benefits for balancing may be limited because STOR itself requires a window of at least 20 minutes.

It should be emphasised that this analysis will only provide a theoretical upper limit of the effect that smart grids could have on balancing costs. In practice, there may be an unavoidable trade-off between using smart-grid-enabled DSR for balancing purposes and using smart-grid-enabled DSR for decarbonisation or deferring network reinforcement. As a result, there may only be a finite amount of smart-grid-enabled DSR that can be set aside for balancing purposes if suppliers and DNOs are simultaneously looking to utilise that DSR for other purposes.

5.2.3 Deferring transmission network investment

As a result of the need to decarbonise the sector, generation will connect to the network in new locations. This will require significant investment in the transmission network. National Grid Electricity Transmission indicate in their recent price control submission that around 60% of their proposed £14.0bn capital expenditure programme during the RIIO-T1 period is driven by spend to connect new generation and new load.

To the extent that it helps flatten the demand profile either for GB as a whole or for areas in which demand growth is a key driver of network reinforcement, smart grid-led DSR could help defer this long-run need for transmission network reinforcement. Figure 13 below provides a stylised illustration of this.

Figure 13. Stylised illustration of how lower peak transmission load flows could defer network reinforcement

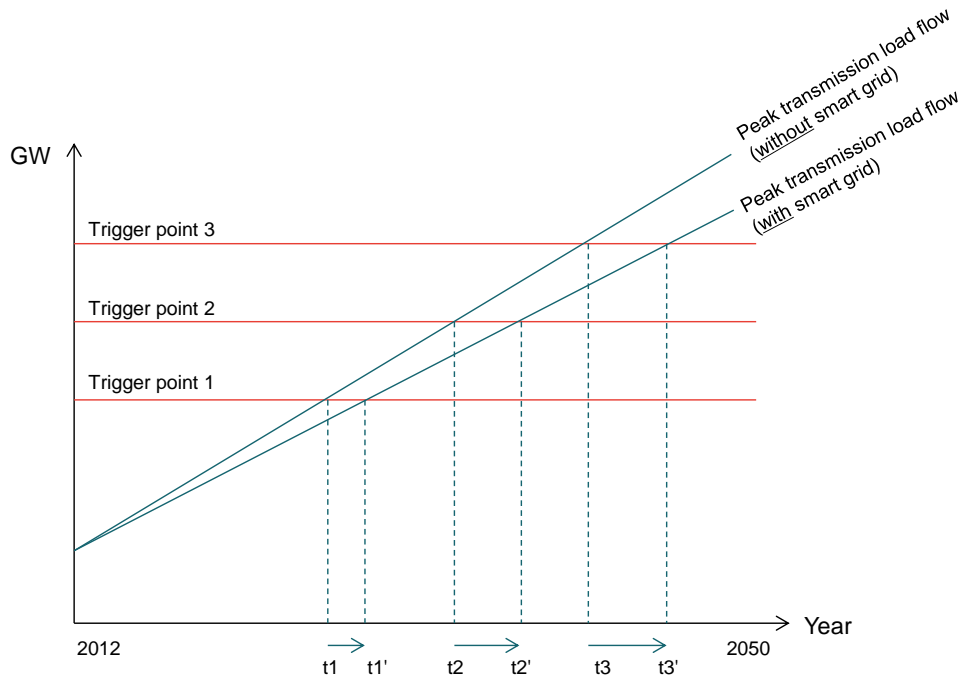

Source: Frontier Economics

In the stylised framework set out in Figure 13, National Grid opts to reinforce the transmission network (rather than incur congestion) once peak load flow reaches certain ‘trigger points’. Each of these network reinforcements adds a discrete lump of additional capacity that alleviates congestion on key points of the transmission network. National Grid then returns to relying on congestion management tools as and when relevant until peak load hits the next reinforcement trigger point.

As Figure 13 illustrates, the introduction of smart-grid-enabled DSR could flatten the trajectory of peak load growth, thereby pushing back the dates at which these reinforcement ‘trigger points’ are hit. This will reduce the total cost of transmission network reinforcement between 2012 and 2050 in net present value (NPV) terms.

In light of this, one option would be to build this stylised model of transmission network reinforcement into our evaluation framework. As outlined above, our framework model will generate peak load flow profiles between 2012 and 2050 for both the business-as-usual solutions and the smart grid solutions. By combining these load flow profiles with an assumed set of network reinforcement trigger points and typical reinforcement costs, this framework will take these impacts into account.

Value chain analysis

However, this approach would have a number of limitations.

- It should be emphasised that such an approach will, at best, only provide a simple estimate of the implications of smart grids for transmission network reinforcement costs. A complete analysis of the implications of smart grids for transmission network reinforcement costs would need to break the transmission network down into each of its constituent zones and separately map flows and resulting levels of congestion on the interconnectors between each of these zones. However, such an analysis is beyond the scope of the simple, transparent and user-friendly framework for evaluating the impact of smart grids that workstream 2 is seeking to develop.
- The approach also assumes that the transmission system operator would have perfect foresight. However, in practice transmission network reinforcements are typically “lumpy” (in the sense that they add a discrete chunk of capacity to the network in one go) and take years to plan. As a result, National Grid would need to commit to a reinforcement package a number of years ahead of the point at which reinforcement would be ‘triggered’ in our evaluation framework. Unless smart-grid-enabled DSR were to have a significant effect on the trajectory of peak transmission load flow profiles, then it might not have a material bearing on the timing of reinforcement.

In light of these potential limitations, we would welcome comments on the utility of this potential approach to measuring the impact of smart grids on transmission network investment expenditure.

5.2.4 Generation/supply

In this section we consider generation and supply companies together, under the assumption that both will be directly affected by any change in generation costs.

The impact on generation and supply businesses of smart grids will be highly dependent on the additional functionality of smart grids over and above smart meters. As set out above, for the purposes of this consultation document, we assume that:

- dynamic supplier-led DSR is possible using smart meters alone; and
- smart grids are required to deliver DNO-led DSR.

Should these assumption be changed following the consultation, we will revise the value chain analysis.

Under these assumptions smart-grid-enabling technologies could allow DNOs to set dynamic time of use tariffs based on real time half hourly LV network costs (in addition to generation and transmission costs). This will change demand profiles and thereby affect generation costs. Similarly, the use of embedded

storage could allow DNOs to smooth demand to reduce network peaks, and thereby impact on generation costs.

Whether DNO-led DSR and embedded storage increases or decreases generation and supply costs will depend on the extent to which local distribution network peaks coincide with peaks of demand net of intermittent generation on the wider system.

- Where these peaks coincide, DNO-led DSR and embedded storage will reduce generation/supply costs.
- Where these peaks do not coincide, DNO-led DSR and embedded storage will potentially increase generation/supply costs. For example, if DNO-led DSR moved demand away from following wind output, to reduce distribution network costs, generation costs could increase (though overall system costs could simultaneously fall).

As explained in Section 6 below, our framework will assess the impact on generation costs of DSR and embedded storage.

5.2.5 Customers

In theory, wherever smart grid investments reduce the overall costs of providing electricity to customers, customers should benefit through lower bills. Customers will therefore potentially benefit from each of the services provided by smart grids, to the extent that they reduce costs over the conventional alternatives.

We propose to make assumptions on the sharing of benefits with customers that will result from:

- the distribution network price control;
- the transmission network price control; and
- the design of the supply market.

These assumptions on cost sharing will be transparent, and will be fully flexible for users in the model.

Value chain analysis

Questions for consultation from Section 5

We would welcome respondents' views on the following questions:

- Are there any other groups in society that we should consider in the value chain analysis?
- Do you agree with our conclusions regarding the distribution of costs and benefits?
- Do you agree with our proposed approach to assessing the costs and benefits for the transmission network?

6 Proposed model specification

This section describes at the model that we propose to construct in order to explore the value of smart grid investments under uncertainty.

Any model is, by definition, a simplification of the real world. We believe that the most valuable output from a CBA of smart grid investment will be to increase our understanding of the broad factors that could affect the value of these investments. This can help answer questions about the type of world in which different patterns of investment are optimal, and where the greatest benefits are likely to accrue.

To do this, the model must be transparent enough to enable users to see what is driving the results, and observe the impact of adjusting key assumptions. The model we propose, while still complex, aims to focus on the most important aspects of the evidence framework (identified in the previous sections of the report). We plan to implement it within Microsoft Excel⁶¹, which will enable users to alter many of the key assumptions without knowledge of more specialised software.

In this section:

- We first describe the overall structure of the model, which can be divided into three main parts:
 - the “real options CBA model”, the component of the model which calculates net present values;
 - the “network model”, the component which determines the costs of meeting peak demand on the distribution network; and
 - the “generation model”, the component which calculates the cost of meeting GB electricity demand.
- We then describe each of these parts in turn in more detail.
- Finally, we set out the interactions between the generation and network models.

⁶¹ While the network modelling work will utilise the outputs of EA Technology’s WinDebut low voltage network design tool, this is a “one-off” process which will not need to be re-run each time an assumption is changed within the model.

6.1 Structure of the model

This section begins by setting out the overall approach to estimating the costs and benefits of alternative investment strategies. It then discusses each element of the model at a high level, before outlining the interactions between each of these elements.

6.1.1 Overall approach to estimating costs and benefits

The model aims to calculate the costs and benefits of alternative distribution network investment strategies. It will do this:

- for each of the investment strategies (business-as-usual, top-down and incremental) described in Section 4; and
- across each of the three scenarios described in Section 3.2.

There are a variety of ways in which smart grid technologies may allow benefits for society to be realised. For example, the smart grid might facilitate the connection of more low-carbon technologies (such as electric vehicles), displacing more polluting technologies and leading to a reduction in emissions. In addition, the increased monitoring of distribution networks could enable increases in supply reliability.

However, as set out in Section 2, we consider that such outcomes can generally be achieved in the absence of smart grid investment (albeit potentially at higher cost), through traditional reinforcement. As such, our model will hold outcomes such as overall emissions targets and supply reliability standards constant. The difference in net present value (NPV) between investment strategies will therefore be mainly dependent upon the variations in the costs associated with meeting these outcomes. However, where different strategies result in different impacts on carbon emissions (e.g. through their impact on generation patterns) or security of supply (e.g. through ancillary supply quality benefits of some grid investments), these will also be taken into account.

6.1.2 High level structure

Our model considers two broad categories of cost.

- The “distribution network model” assesses the costs of upgrading the distribution networks to accommodate changes on the supply and demand side. It determines the investments required by DNOs to ensure that all feeders are capable of meeting peak demand and accommodating distributed generation.
- The “wider electricity sector model” calculates the cost, and the emissions implications, of meeting demand over the course of each year (including

Proposed model specification

ensuring the system can be balanced and that there is sufficient capacity on the transmission network).

These models will be run multiple times, to obtain cost figures for each combination of scenario and strategies.

Finally, the “real options CBA model” combines the outputs of these models to calculate net present values and related indicators for each of the investment strategies.

Figure 14 illustrates the overall structure of the model.

Figure 14. Model overview

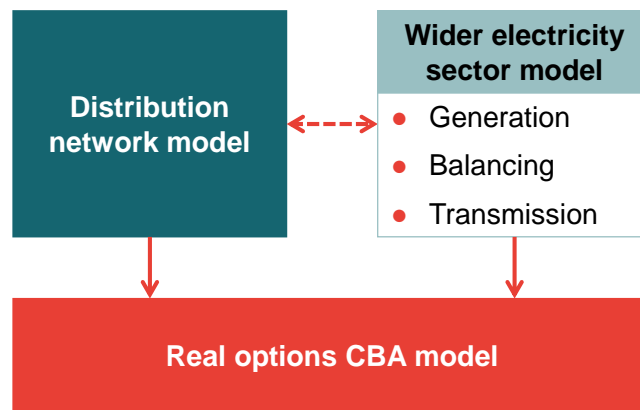

Source: Frontier Economics

6.1.3 Interactions between the models

Some smart grid interventions modelled within the distribution network models will not impact on wider electricity sector mode. For example, installing dynamic line rating on a feeder (modelled within the network model) is unlikely to affect the overall demand profile for energy (which affects the cost of generation).

However, the presence of smart grid measures which impact on demand profiles, for example demand-side response (DSR) and embedded storage, complicates this situation. If DNOs actively shape the demand profile on a sufficient number of feeders, then this will lead to changes in overall demand across Great Britain, with a consequent impact upon generation and transmission costs. Similarly, if suppliers or the system operator change demand profiles to better utilise increased wind capacity, this will result in differing levels of demand on each local feeder. This introduces interdependencies between the two main parts of the model (as shown in Figure 14). In Section 6.5, we set out how the interaction between these two parts of the model will work.

We first describe each section of the model in turn:

- the real options CBA model;
- the distribution network model; and
- the wider electricity sector model.

6.2 Real options CBA model

The outputs of the network and two generation models will be run through a real options CBA model.

As described in Section 2.3.1 above, the real options approach allows us to take account of the different investment profiles of the alternative strategies, and the different flexibility in the face of uncertainty that these profiles imply. In particular, it allows us to model the impact of lock-in. That is, it allows us to account for the fact that one investment option in the first period may lead to a reduced set of investment options for the second period, for example because a large amount of investment is undertaken up front. Essentially this will involve:

- carrying out cost-benefit analysis of each strategy against each scenario over two periods: 2012-2023 and 2023-2050;
- ruling out strategies which are not possible in the second period, given the choice of strategy in the first period;
- comparing the NPVs in the resulting matrix of possible outcomes; and
- assigning probabilities to each scenario, and calculating probability weighted NPVs for each strategy undertaken in the first period.

Figure 15 shows an illustrative example of the matrix of possible outcomes that the model will produce. Lock-in means that some combinations of first-period and second-period investment will not be included within the output – these are shaded in grey in the illustrative example provided below. The model will highlight, out of the remaining second-period investment options, the one which provides the highest NPV (shaded blue in the illustrative example below).

Figure 15. Illustrative output table

Period 1	Period 2	Net cost to 2050 under		
		Scenario 1	Scenario 2	Scenario 3
BAU	BAU	£££	££	£££
BAU	Incremental	££	£££	££
BAU	Top-down			
Incremental	BAU			
Incremental	Incremental	££	£££	£££
Incremental	Top-down	£££	££££	££
Top-down	BAU			
Top-down	Incremental	££	£££	££
Top-down	Top-down	£££	££££	£

Source: Frontier Economics

Costs will be in monetary terms

Using these figures, the model will be able to do the following:

- calculate the net present value for each investment strategy; and
- identify “least regret” options, the option minimising the risk of the worst case outcome occurring, and where the “trigger points” for investments may lie.

The model will enable the user to “drill down” to the figures underlying the main results (for example, the split of costs between those associated with network reinforcement and those associated with generation).

6.3 Distribution network model

The proposed technical methodology has evolved from work completed by EA Technology to estimate the future cost savings to support both the Customer Led Network Revolution (August 2010) and New Thames Valley Vision (August 2011) LCNF Tier 2 projects.

In the following sections, we describe:

- the overall approach and coverage of the model;
- the representative network types that we propose to use;
- how the proposed model will calculate the available headroom for each feeder;

- the assumptions made regarding the penetration of low-carbon technologies (in particular, how they may cluster on feeders);
- the way in which the model will apply investments in response to diminished headroom; and
- how we propose to incorporate more centralised investments, which may not take place on a feeder-by-feeder basis.

6.3.1 Overall approach

We propose to take a parametric, probabilistic approach, rather than a nodal approach. This permits significant simplification and avoids the need to model multiple feeders and load flows. A nodal model and parametric model are defined as follows:

- **Nodal model:** a full load flow of a network, modelled as a set of points (nodes) and connections. In this type of model, power draw-off (loads) and power injection (generation) can be added as time varying profiles.
- **Parametric model:** one which does not model load flow, but uses higher-level abstractions, such as various types of “headroom”. Headroom is the difference between the actual power flows, voltages and power quality measurements and the limits set by network design, equipment ratings, or legal / licence requirements. Headroom is amenable to statistical treatment and enables the outcomes of a nodal model to be extrapolated to a primary group, a borough, a license area or GB without a full time-varying load flow of the network being required.

The aim is for the model to represent a typical distribution network⁶². It will not encompass every possible condition or topology that may occur on GB networks.

The model will consider a variety of representative feeder types. These will include LV networks (with generic “urban”, “suburban” and “rural” networks), in addition to high voltage networks (at 11kV, 33kV and 132kV).

The feeders’ capacity to host higher levels of low-carbon technologies (such as EVs, heat pumps, solar PV or distributed wind generation) is determined by their available thermal and voltage headroom.⁶³ The model considers a range of

⁶² The approach to modeling the impact of measures on the transmission network is discussed in Section 5

⁶³ As voltage and thermal issues are the dominant drivers for load related investment today, headroom for fault level and power quality will not be incorporated into the model. Either could be built into the model in the future if it were deemed necessary.

Proposed model specification

different initial headroom levels, as feeders with lower headroom will, all else being equal, require investment sooner than those with greater headroom available.

The effect of the increasing penetration of low-carbon technologies will be modelled, taking into account clustering that may occur. Engineering calculations will be used to predict the effect upon thermal and voltage headroom.

When the model indicates that headroom will be breached for a particular group, then a network investment (whether a smart solution or conventional reinforcement) will be undertaken (though for the top-down strategy, some investment may occur ahead of need). This investment will be associated with a cost, which will ultimately form part of the overall cost used in the real options CBA model.

As outlined above, this model will be run for each combination of investment strategies (including business-as-usual) and scenarios.

A representation of the structure of the model is given in Figure 16. The various sections of this figure (labelled as 1 – 3) are expanded upon in later diagrams in this section.

Figure 16. Structure of distribution network parametric model

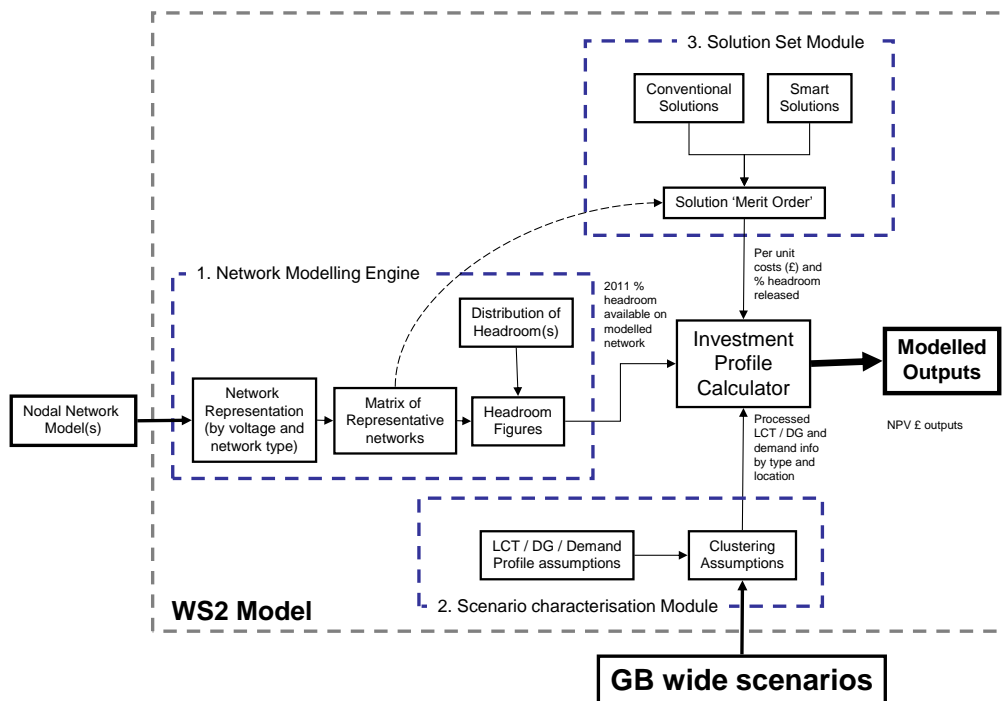

Source: EA Technology

6.3.2 Choice of representative networks

The parametric approach we plan to adopt avoids the need to model a network of multiple feeders. Instead, it requires the selection and modelling of a range of generic representative networks, the results for which are extrapolated across the country.

An important trade-off for this type of model involves the range of feeders which are modelled. Distribution networks in GB vary across a wide number of dimensions, including:

- voltage (e.g. 132kV, 66kV, 33kV, 20kV, 11kV, 6.6kV and LV);
- type of network (e.g. fully underground, fully overhead, or a mixture);
- network topology (e.g. radial, meshed, open ring, single circuit or double circuit);
- feeder length / impedance;
- the extent to which the feeder has additional capacity available;
- load density; and
- the distribution of demand along the feeder (e.g. uniformly distributed, or clustered near to or far away from the feeding substation).

Modelling all possible combinations of feeder (there would be in excess of 500) would produce an unwieldy model. It is therefore necessary to select a smaller number of representative feeders, which nonetheless encompass a large proportion of GB distribution networks.

Many of the drivers and smart grid interventions will occur at the LV level. We propose to model three generic LV feeder types (representative of urban, suburban and rural networks). Within each of these categories, the model will also consider a number of differing “strengths” of network, ranging from those which have considerable amounts of spare capacity, to those which are already reaching their limits. This is discussed further below.

At the higher voltage levels, we propose to model generic 132kV, 33kV and 11kV networks, using average network data at each voltage level. Figure 17 illustrates the relationship between the different voltage levels in the network. Again, we will consider a distribution of different strengths of network.

Proposed model specification

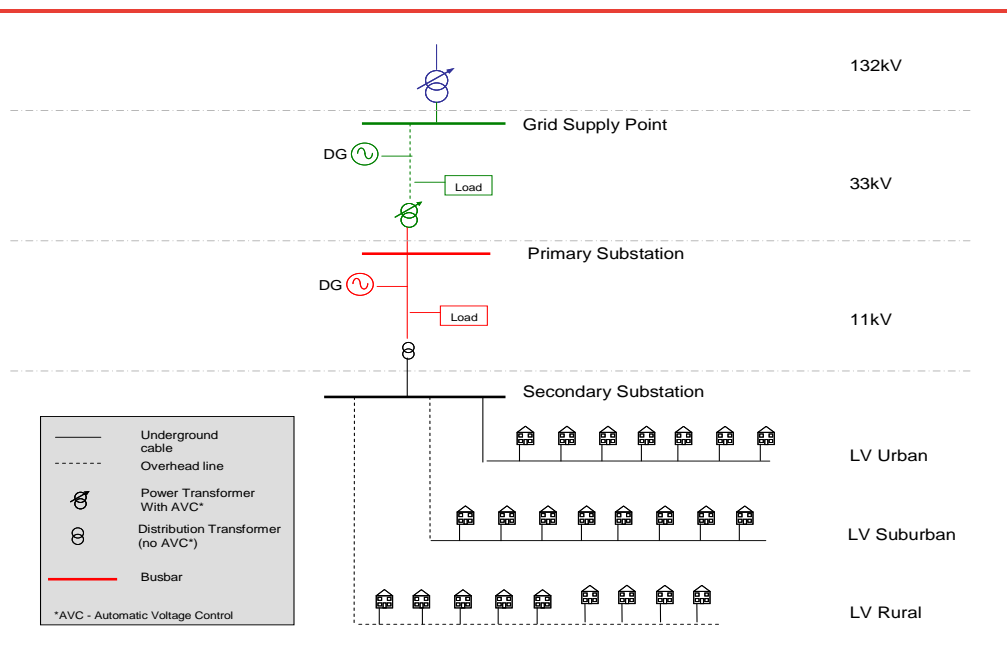
Figure 17. Schematic diagram of the network model

Source: EA Technology

The schematic (nodal) model will be represented by a series of parameters, as described in Table 8.

The model will be designed in such a way that it is relatively easy to add further representative network types in future if desired.

Table 8. The parametric model structure

	% Voltage Headroom	% Thermal Headroom	% of GB networks
132kV Grid Supply Point	x	✓	100%
33kV circuit	✓	✓	100%
33/11kV Primary transformer	x	✓	100%
11kV circuit	✓	✓	100%
11kV/LV Secondary transformer	x	✓	100%
LV circuit (urban)	✓	✓	32%*
LV circuit (suburban)	✓	✓	40%*
LV circuit (rural)	✓	✓	28%*

All ticks represent data input that will be preconfigured into the model based on measurement or estimates of current network operation in GB *

*For illustration only, scaling can be tailored to reflect the split of each type of networks in GB

Source: EA Technology

6.3.3 Headroom

This section sets out our approach to modelling the headroom available for each type of feeder. As explained above, the concept of headroom provides us with a simple way of expressing how close each feeder is to requiring DNO intervention.

We will base the modelling on the outputs of a nodal time-stepped load flow model of the representative feeders. This work is based on the outputs of previous modelling of real feeders and gives good estimates of the headroom for a typical range of networks. However it is known that there are a range of “strengths” of network, from some that are close to (or slightly beyond) limits on occasions, to some that are over-designed for their current usage. We will therefore extrapolate from the nodal model results to estimate the range of headroom of feeders.

Proposed model specification

We will represent networks by two figures for available headroom: one for thermal and one for voltage. The headroom figures will be applied as a distribution (essentially an assumed average with typical high and low estimates⁶⁴). For LV these will be different based upon the network type (urban, suburban or rural). Note that the initial headroom of feeders will not vary across scenarios (since they will all start with the current levels of demand), but the differing penetrations of low-carbon technologies across scenarios will cause headroom figures to diverge.

The way in which the representative networks and headroom will be modelled is illustrated in Figure 18.

Figure 18. Network modelling engine

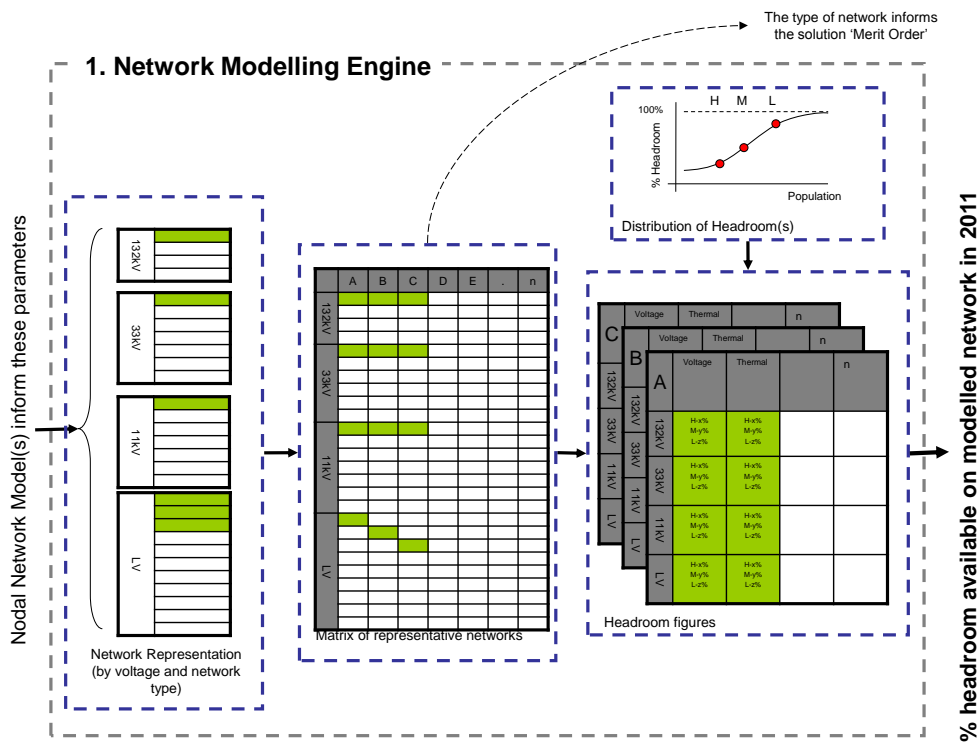

Source: EA Technology

Headroom at Low Voltage

The headroom figures, both thermal and voltage, for the LV networks will be based on the outputs of a nodal time-stepped load flow model using EA

⁶⁴ Note that the model can be extended to cover a more fine-grained distribution of feeder strengths (for example, deciles).

Technology's WinDebut LV network design software of a representative “strong feeder” (500kW new build) and a representative “weak” feeder (100kW 50 year old rural village network)⁶⁵. The combination of low-carbon technologies or small scale generation, taken from the WS1 scenarios, with the headroom available at a given point in time will determine when voltage and thermal limits on the LV network are breached:

- without the connection of low-carbon technologies;
- with PV randomly connected⁶⁶; and
- with other low-carbon technologies randomly connected.

Headroom at Higher Voltages

For the higher voltage networks, we propose to derive the base headroom figures for the network by modelling the simplified network model in conventional HV planning tool (e.g. IPSA+, DIgSILENT PowerFactory etc) using average network impedance and loading information.

The combination of Distributed Generation, taken from the WS1 scenarios, with the headroom available at a given point in time will determine when voltage and thermal limits on each of the higher voltage networks are breached:

- without the connection of distributed generation;
- with distributed generation connected and clustered in different ways

For all network voltages a range of appropriate mitigating interventions can then be applied to the feeder model once thermal or voltage limits are breached. The number of low-carbon technologies, small-scale generation or distributed generation that can be connected without breaching limits will be recorded. Then more low-carbon technologies, small-scale generation or distributed generation can be added until the limits are again breached. The new maximum number of devices will be recorded for each mitigating intervention. This process enables the “solution stacks” of interventions (described below) to be created.

⁶⁵ We are not aware of similar work with published figures. If DNOs have suitable design studies that they have carried out on other feeders then these can be incorporated. It is hoped that the range of representative feeders will be increased by the WS3 modelling activity. This model will recognise that there are more representative types of feeder, but will not be populated with their characteristics until that information is made available (e.g. by WS3 activity or DNO design studies)

⁶⁶ PV is being treated differently to other low-carbon technologies because, unlike the other technologies, its most significant impact is during the middle of the day. For this reason, it is regarded as being sufficiently dissimilar in its effect on headroom profile to the other technologies to warrant it being assessed individually.

Proposed model specification

DNOs have significantly more modelling expertise and data for higher voltage networks. In contrast, the LV network does not tend to be accurately modelled, nor is the infrastructure in place to derive accurate measurements. We therefore draw out our approach to determining LV headroom in more detail in the following section.

Specifics for representing LV thermal headroom

The triggers for enacting solutions to solve thermal headroom problems are usually a result of higher current than the static cable or plant ratings.

We will base the figures for urban, suburban and rural thermal headroom on outputs from the WinDebut model, sense checked by engineering judgements of DNO staff regarding where typical networks operate. As explained above, the use of central, high and low estimates of headroom will enable us to model the distribution that exists. Although data here is sparse, we would expect these assumptions to be sharpened with the output of LCNF projects (e.g. LV Templates, Customer Led Network Revolution, etc.).

Specifics for representing LV voltage headroom

A sufficient concentration of distribution network-connected generation (such as PV) has the potential to lift the voltage on the network. In contrast, higher circuit loadings (e.g. caused by the connection of EVs) will depress the voltage. It is therefore necessary to model voltage headroom (the margin below the upper voltage limit) and legroom (the margin above the lower voltage limit).

As with thermal headroom, assumptions are required for the distribution of existing voltage headroom across the representative feeders. We will base the central, high and low estimates on data taken from one DNO, which has monitored LV busbar voltages across a portion of their network. This will also be sense checked against the outputs from the WinDebut model. Again, data here is sparse, but we would expect these assumptions to be sharpened with the output of LCNF projects.

The outputs of the WinDebut model can then be extrapolated to give the number of PV installations that can be connected to other feeders without breaching voltage headroom, by assuming that voltage rise is proportional to the change in power. Additional generation can therefore be added to high headroom feeders in proportion to the additional voltage headroom, conversely proportionately less generation can be connected to low headroom feeders.

We can check the likely voltage legroom (available volts above statutory limits at end of LV feeder) by assuming that voltage drop is proportional to the change in power. This will enable the model to check the numbers of EVs and HPs that could be connected to weak LV feeders without breaching voltage legroom.

In previous versions of this network model, it was assumed that the additional load from heat pump installations would only come from heat pumps themselves. There is increasing evidence that heat pumps, in particular, are giving rise to low voltage issues in very cold conditions (some units have up to 10kW heaters included to boost the heating ability in very cold weather). This is an area where we intend to develop our thinking further.

This gives us the network base case, represented as a series of figures of percentage of available connections.

6.3.4 Clustering of low-carbon technologies

We will input data on low-carbon technologies into the model based on the scenarios from WS1. This section sets out how the network model will simulate the penetration of these technologies across feeders over time.

The impact of low-carbon technologies on networks will depend partly on the extent to which they are clustered, rather than distributed evenly across feeders. Clustering may occur because those who purchase the technologies will be influenced by their friends and neighbours, and different social groups will adopt the technologies at different rates. This clustering has the potential to cause problems on the network significantly earlier than if the low-carbon technologies were distributed evenly.

In the previous modelling work carried out by EA Technology, the extent to which installations cluster was estimated using the 'Feed-in Tariff Installation Report 30 June 2011' (henceforth referred to as: FiT data) provided by Ofgem. This provides the first few digits of post code for each installation.

We have no data relating to clustering of EVs and HPs. In the absence of these data we can assume that EVs and HPs will cluster in the same way as PVs. However, we welcome comments on alternative approaches.

From inspection of the FiT data we identified that it was appropriate to divide the data into five groups, which are shown in the table below.

Proposed model specification

Table 9. LCT clustering, based upon FiT data

Percentage of network	Percentage of LCT installations
1%	9%
4%	17%
25%	48%
30%	22%
40%	5%

Source: EA Technology

This information, together with the estimates of numbers of connections of PV, heat pumps and EVs across GB, will be used to calculate how rapidly five different groups will adopt the low-carbon technologies.

Once all connection points in a network group have been used, then those low-carbon technologies that can no longer be accommodated within that group are redistributed proportionally across the other groups.

The model will assume that the degree to which clustering occurs, for a given penetration of low-carbon technologies, is the same across the different scenarios. However, scenarios with a higher penetration of low-carbon technologies may be modelled as having a more uniform distribution of them. This is due to the issue explained above: once modelled penetration within a cluster reaches 100%, the model will have to allocate additional low-carbon technologies more widely across the feeders⁶⁷.

The characterisation of scenarios and clustering levels is illustrated in Figure 19.

⁶⁷ This is simply due to the way in which (by definition) penetration cannot exceed 100% - it is not a result of headroom limits on the network.

Figure 19. Scenario characterisation

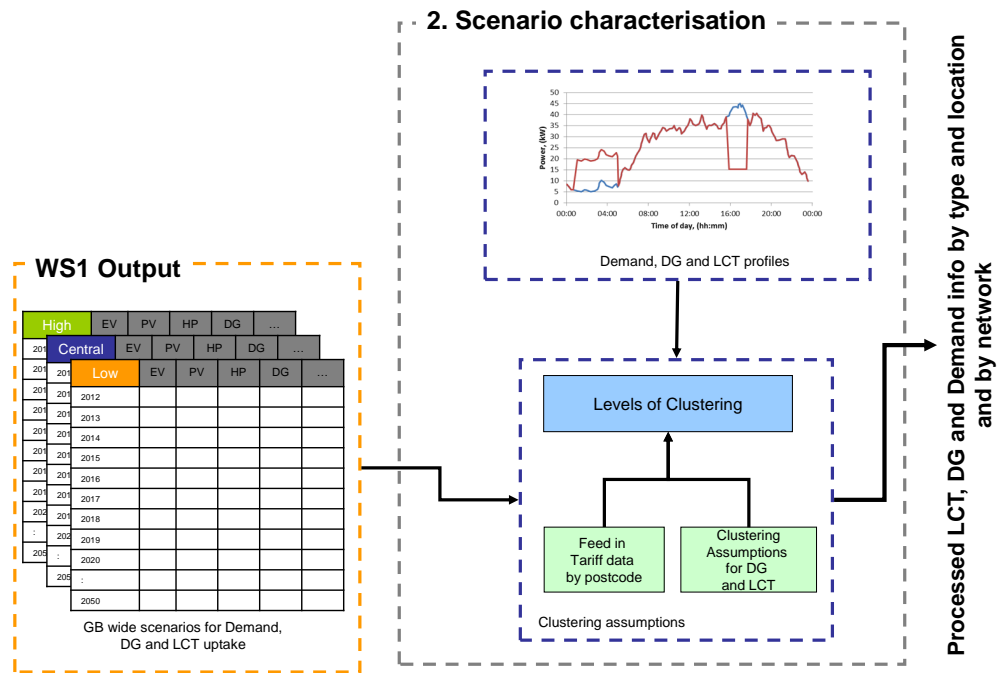

Source: EA Technology

6.3.5 Distribution network investment

This section explains how distribution network investments will be triggered by changes in the available headroom on each feeder.

The increased penetration of low-carbon technologies (as well as any organic growth in demand) leads to a reduction in headroom on each feeder. Each investment strategy (top-down and incremental) will be associated with a different priority stack of smart and conventional investment solutions. When the trigger points for thermal or voltage headroom (or voltage legroom) on a feeder are reached, the model looks to select the next available smart or conventional investment solution from a “priority stack” and implement this solution so as to increase the available headroom. Figure 20 provides a stylised illustration of this process. Note that, while this diagram only indicates thermal headroom, the model will simultaneously be ensuring that voltage headroom (or legroom) is within acceptable limits.

Proposed model specification

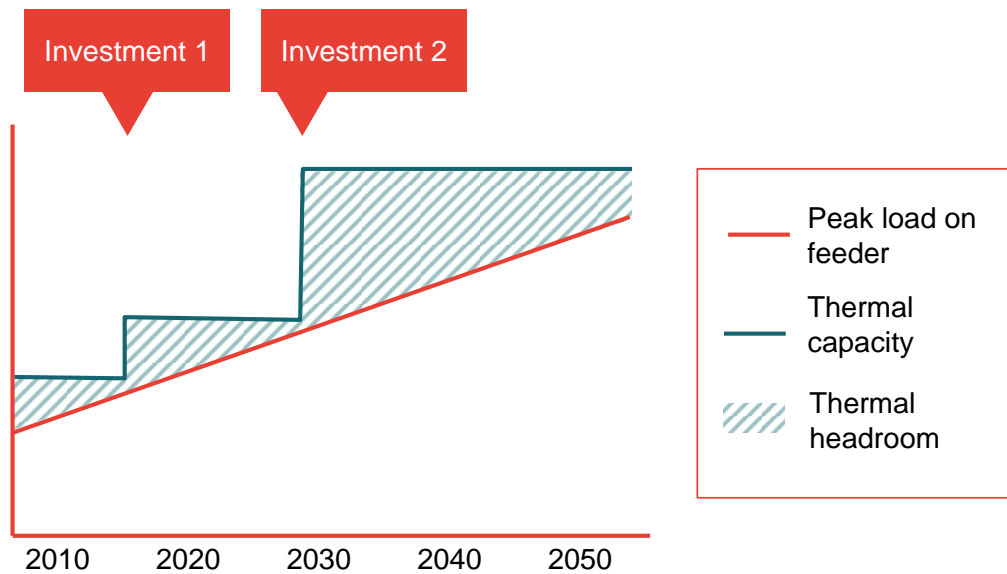
Figure 20. Illustration of network investments

Source: Frontier Economics

The model will allow various “distribution network” solutions to be applied. Some of these will be conventional reinforcement options. Under business-as-usual these will be the only options available, while even under the smart grid strategies these will still generally be required (but their timing may be deferred). These are to:

- split the feeder (that is, transfer half of the load of the existing feeder onto a new feeder);
- replace the transformer; and
- new split feeder (that is, run a new feeder from the substation to the midpoint of the already split feeder and perform some cable jointing to further split the load, resulting in three feeders each having approximately equal loads).

Under the two “smart” investment strategies, a number of additional technologies will become available. We recognise that there are a large number of potential smart grid technologies. The phase 1 report from WS3 identifies 12

categories or ‘smart solution sets’. For each of the relevant⁶⁸ categories, our proposed model will allow up to 10 different intervention types.

However, at present, there are great uncertainties regarding the effect that some smart grid interventions will have. Populating the model with a large number of intervention types is therefore unlikely to provide a great increase in the accuracy of the cost/benefit estimates, but will lead to significantly increased data requirements.

We therefore propose to pre-populate the model with four examples of smart solutions, which encompass the different types of intervention that are likely to be required:

- dynamic thermal rating (releases thermal headroom);
- enhanced automatic voltage control (releases voltage headroom);
- electrical energy storage (releases both types of headroom); and
- demand side response (releases headroom by changing the demand profile itself).

Each of these solutions has a cost, and each also has a headroom release figure associated with them (for thermal and voltage headroom). The order in which they are applied (the stack) will depend on the network type, the low-carbon technology uptake scenario, and the investment strategy that is being modelled.

Table 10 shows how a collection of priority stacks would look for three types of LV network. It should be noted that this is for illustrative purposes only, to demonstrate how the network type, network voltage and low-carbon technology / generation uptake rate have an effect on the preferred order in which the solutions are applied. This is not a definitive list of the priority stack for the various smart and conventional solutions. It only shows the priority stacks for one particular investment strategy. In the final model, there will be a different collection of stacks for each feasible combination of strategy in each of the two time periods considered by the real options model (for example, an incremental strategy followed by a top-down one; or business-as-usual followed by an incremental strategy). This is illustrated in Figure 21.

⁶⁸ Not all the WS3 categories will be relevant for this model. In particular, the “Smart Transmission Networks” category is not applicable to this model (which focuses on interventions on the distribution networks).

Table 10. Priority stack illustration for a single investment strategy (the solution stacks illustrated are for the three representative LV networks, and the single representative 11kV and 33kV networks).

	Scenario A	Scenario B	Scenario C
33kV	Conventional 1	Smart 1	Smart 1
	Smart 1	Conventional 1	Conventional 1
11kV	Conventional 1	Smart 1	Smart 1
	Smart 1	Conventional 1	Smart 2
	Smart 2	Smart 2	Conventional 1
LV Urban	Smart 1	Smart 1	Smart 1
	Smart 2	Smart 2	Conventional 1
	Smart 3	Conventional 1	Conventional 2
	Conventional 1	Smart 3	Smart 2
	Smart 4	Conventional 2	Conventional 3
	Conventional 2	Smart 4	Smart 3
	Conventional 3	Conventional 3	Smart 4
LV Suburban	Smart 3	Smart 3	Smart 3
	Smart 4	Smart 4	Conventional 1
	Smart 1	Conventional 1	Conventional 3
	Conventional 1	Smart 1	Smart 4
	Smart 2	Conventional 3	Smart 1
	Conventional 3	Smart 2	Conventional 2
	Conventional 2	Conventional 2	Smart 2
LV Rural	Smart 2	Smart 2	Conventional 1
	Smart 4	Conventional 1	Smart 2
	Smart 1	Smart 4	Smart 4
	Conventional 1	Smart 1	Conventional 2
	Smart 3	Conventional 2	Smart 1
	Conventional 2	Smart 3	Conventional 3
	Conventional 3	Conventional 3	Smart 3

Source: EA Technology

Figure 21. Solution set model

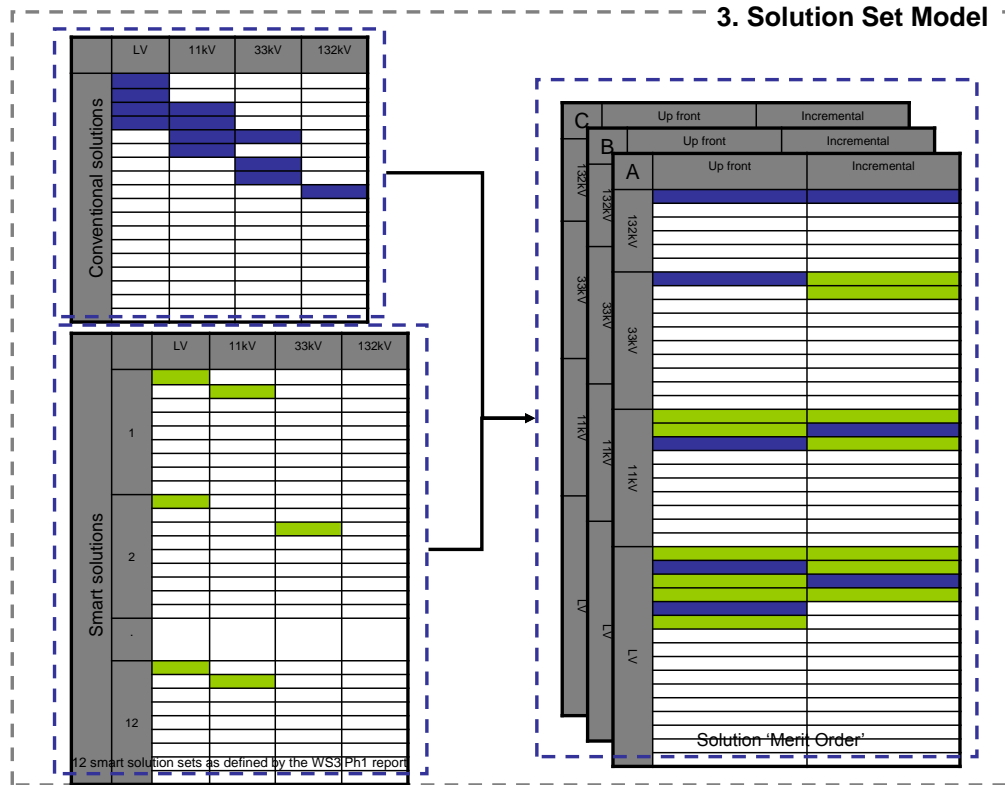

Source: EA Technology

The model will apply the solution from the priority stack and calculate how many years it will be before headroom is anticipated to be breached again and a second intervention is then required. Some solutions give a benefit to both headroom measures, for example if the problem is concerned with thermal headroom then a solution will be implemented to relieve this headroom issue, but may also release some voltage headroom as a secondary effect. The model will recalculate the headroom for both thermal and voltage parameters after applying an intervention such that it can accurately be determined when the next intervention (for thermal or voltage reasons) is required.

Depending on the network type and the low-carbon technology uptake rate, when a second intervention is required, the model will simply take the next solution from the stack and apply it and recalculate headroom. When a third intervention is required, the process is repeated and so on.

The solution stack is built as per the table above, but it can flex such that the priority of different solutions may change over time. Each solution has an implementation cost. Initially, some of the smart solutions may have a high

Proposed model specification

implementation cost as the technology is still being developed. In the future, this cost may be reduced and the model will be able to use different costs for these solutions as time progresses. Therefore, the solution stack may have its priority adjusted as a certain technology becomes more affordable in, say, 2030. The costs associated with each solution in the stack will be flexible to users.

The final outputs will be scaled from a local level to GB level using feeder lengths from Regulatory Reporting Pack ⁶⁹ data.

The output from the network model can be characterised as shown in Figure 22.

Figure 22. Network model outputs

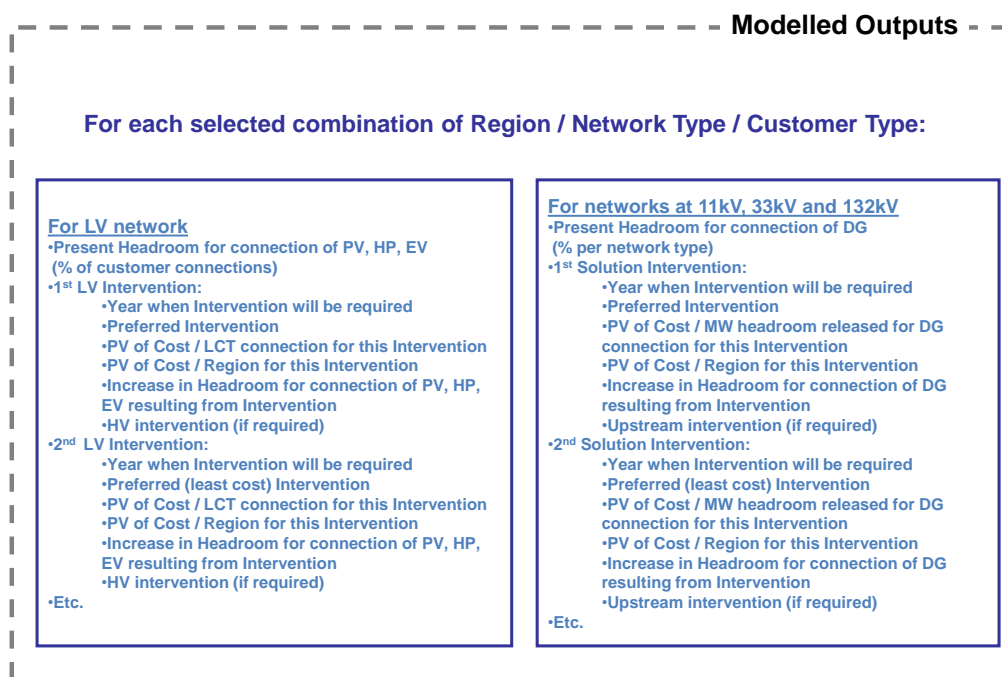

Source: EA Technology

Top-down investment strategy

In the model described above, smart grid investments are made on a feeder-by-feeder basis as and when required due to diminishing headroom. However, as described in Section 4, it may also be possible to implement smart grid technologies by making large one-off investments that affect large numbers of

⁶⁹ Ofgem's regulatory reporting pack is available here: <http://www.ofgem.gov.uk/Networks/Trans/RegReporting/Pages/RegulatoryReporting.aspx>

feeders at once. In order that we capture such types of investment, our smart grid investment strategies will assess both “top-down”, and “incremental” investment strategies.

The top-down strategy will be modelled separately to the priority stacks described above. This is because, when a centralised investment is made, it is likely that many of the feeders it affects will not have reached their headroom limits. The model will therefore have the ability to “force” on such investments, regardless of the remaining headroom.

The model will be flexible enough to allow the overall costs of such investments to vary from the feeder-by-feeder approach (to take account of any economies of scale), as well as the benefits (in terms of headroom saved). This should allow us to capture any possible benefits of adopting a more ‘holistic’ or top-down approach to smart grid investment.

6.4 Modelling the wider electricity sector

We now go on to describe the wider electricity sector model. This is set out in Figure 17 and involves:

- building representative half-hourly demand profiles for Great Britain as a whole;
- creating representative half-hourly profiles of intermittent (primarily wind) generation;
- setting up a merit-order “stack” of other generation technologies; and
- determining the amount of energy required each for half hour from each of these generation types, to meet demand (net of intermittent generation).

In addition to generation costs, the model takes account of two further types of cost:

- **The cost of ensuring there is sufficient flexible generation to enable the system to be balanced at all times.** This will be taken into account by using constraints upon the minimum flexible reserve capacity that is required.
- **The cost of transmission network reinforcement to meet changed peak demand.** The model will consider the peak power flows that the transmission network will be required to cope with and, and provide a very high-level estimate of any investments. These are described in Section 5.2.2.

Proposed model specification

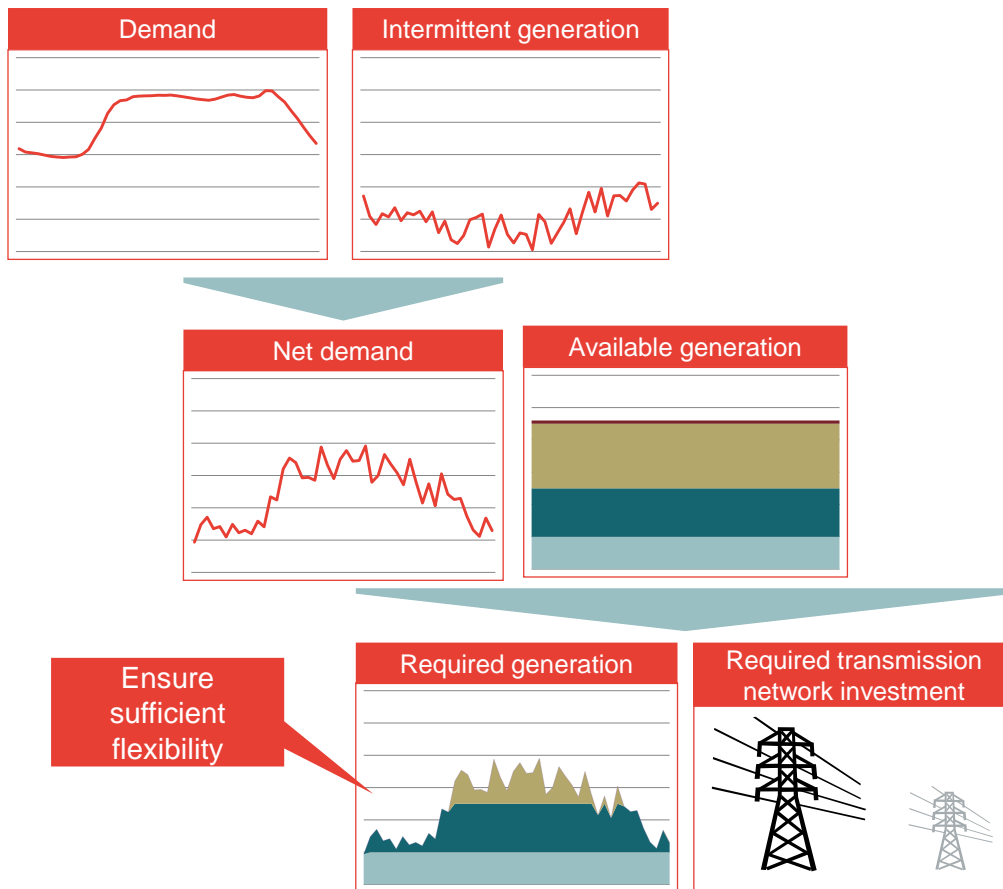
Figure 23. Generation Wider electricity sector model overview

Source: Frontier Economics

6.4.1 Representing demand

In common with the distribution network model, demand will be represented using a half-hourly profile across a representative day (separately for both summer and winter). These GB-wide demand profiles will be built up from the same low-carbon technology penetration rates and hourly demand profiles as used in the distribution network model, to ensure consistency. Additional sources of demand (notably industrial loads) will be incorporated at this stage.

As explained above, some smart grid technologies will require the demand profiles to be adjusted. (e.g. embedded storage, and technologies that enable DSR). The modelling of DSR is explored in Section 6.5.2, but is set aside here.

6.4.2 Modelling intermittent generation

Our model will consider two different types of intermittent generation:

Draft

Proposed model specification

- wind (onshore and offshore); and
- micro solar PV.

For the purposes of the cost calculations, it is assumed that these technologies have no variable costs (i.e. costs that vary directly with energy generation).

Wind

Wind generation (onshore and, increasingly, offshore) is likely to form a key element of the future generation mix⁷⁰. Wind is, by its nature, intermittent. While on average the electricity supplied by wind generation follows predictable seasonal and hourly patterns, the actual power delivered by wind at a given period can vary widely from this average. Even though the distribution of wind turbines across the country can help to average out any localised variation, the overall pattern of wind generation remains “noisy”.

This effect can have a large impact upon the overall costs of generation. If demand cannot be time-shifted sufficiently, then large quantities of peak-load plant may be required to run when wind generation is insufficient. On the other hand, if high wind output coincides with low demand, curtailment of wind generators may be required (since base load plants are unable to decrease their supply). Wind intermittency is therefore a crucial part of the generation model.⁷¹

Our approach will be to create a small number of representative half-hourly wind profiles (separately for both summer and winter patterns of wind). These will capture various possible outturns of wind (including not only unusually high and low levels of wind, but also a variety of irregular peaks and troughs).

Each profile will be associated with a probability, which indicates the proportion of days in the summer or winter that would be expected to have a similar profile of wind generation. The resultant distribution of future wind generation will be as consistent as practical with more detailed forecasts (for example ensuring that summary statistics such as the mean and standard deviation match). Note that our model will not explicitly model the possibility of wind output being correlated between days (for example, an entire week with lower than expected wind output). However, since we assume that the transfer of energy enabled by DSR and embedded storage will always be within a single day, this will not affect the results of the generation model.

⁷⁰ See for example, CCC (2010) *The fourth carbon budget*, <http://www.theccc.org.uk/reports/fourth-carbon-budget>

⁷¹ From a DNO perspective, the most significant result of increased wind penetration will be the way in which wind-following tariffs may lead to changes in demand profiles. Section 6.5 below describes how this will be taken into account.

Proposed model specification

Special care will be taken to ensure that a “worst case” (from the network perspective) wind profile is present, even if the associated probability is low. By “worst case” we mean a profile which tends to have high wind when demand is lowest and vice versa.⁷² When DSR is used to decrease generation costs, such a profile would lead to the highest peak demands on feeders and would therefore drive distribution network costs.

Micro solar PV

The generation model will include the output of micro solar PV installations. This provides consistency with the network model, where such units may lead to voltage headroom issues.

The power from solar PV installations varies both with the time of day (peaking at midday) as well as the season (it is typically highest in mid-summer). Both of these elements can be captured by a half-hourly generation profile for each season.

In addition, the output of each individual solar panel will vary according to the local weather conditions (being lower if the weather is cloudy). Although the total solar output across the whole of Great Britain will follow a smoother pattern, there will still be an element of solar intermittency that is not captured by the half-hourly profiles. However, for the purposes of this model, we do not propose to model such solar intermittency in the same way as for wind.

It is also worth noting that the overall energy supply from micro PV will be considerably lower than that from wind, which decreases the importance of intermittency. DECC’s *2050 Pathways* analysis assumes that an achievable technical potential⁷³ for solar PV by 2050 is 60TWh per year. By contrast, the equivalent assumption for both offshore and onshore wind is would deliver 237 TWh of electricity per year – almost four times as much.

6.4.3 Other forms of generation

The other key input into the model is the capacity of other forms of generation. For each form of generation technology, in each year, we will require:

- the maximum energy that can be supplied within a half-hour;

⁷² The 2010 ENA/Imperial/SEGD report *Benefits of Advanced Smart Metering for Demand Response based Control of Distribution Networks* considers this.

⁷³ This is the “level 2” assumption, which “describes what might be achieved by applying a level of effort that is likely to be viewed as ambitious but reasonable by most or all experts. For some sectors this would be similar to the build rate expected with the successful implementation of the programmes or projects currently in progress”.

- the minimum energy that can be supplied within a half-hour⁷⁴;
- the cost per GWh of energy supplied; and
- the capital cost per MW of capacity.

Where possible, we will use information from DECC consistent with the scenarios provided by WS1 for each of these inputs. Where this information is not available, we will ensure our assumptions are clearly documented. These inputs will be fully flexible to users in the model.

6.4.4 Modelling of required generation

For each season and each demand profile net of intermittent generation, the model can then determine the costs of generation. Starting with the lowest-cost base load plants, the model will deploy sufficient generation in order to meet this demand. This enables both the overall operating cost of generation to be determined, as well as the marginal (most expensive) plant, which will determine the market price of electricity.

If DSR or embedded storage is able to sufficiently smooth demand, then there may be a reduced requirement for peaking plants. If this occurs, the model will determine the quantity of peaking plants required to meet peak demand (net of wind), and any gains will be expressed in terms of the annualised capex associated with these plants.

It is important to note that given the requirement to produce a flexible and transparent model for public domain use, the intention is not to create a fully featured dispatch model for GB. As a result, technical constraints (such as ramping capabilities) will not be taken into consideration. However, we will start our modelling from fully internally consistent generation scenarios. These will therefore include sufficient quantities of peaking plant to meet required security of supply. When the model (as discussed above) reduces the capacity of such plants, we will impose a minimum requirement on the capacity of spare flexible generation required. This will ensure that the modelled fleet of plants should be sufficient to enable the system to be kept in balance.

Pumped storage

Like DSR, pumped storage provides a way in which the demand and supply for electricity at the national level can be brought into balance. The use of pumped storage may therefore enable DSR to be deployed by DNOs to increase feeder

⁷⁴ This will prevent the model unrealistically reducing the output of base-load nuclear and similar plants when demand net of intermittent generation is high. Instead, intermittent generation will be curtailed.

Proposed model specification

headroom, while still enabling demand at GB level to follow intermittent renewable generation.⁷⁵

The modelling of pumped storage is somewhat more complex than simple generators. This is since, in addition to constraints regarding the overall capacity of the units, it is necessary over time for the energy produced by the pumped storage system to equal the energy consumed by the pumps (minus any losses that take place).

It is rational for a pumped storage unit to operate whenever the spread between the price of electricity used when generating and pumping is greater than its operating costs. Since the model produces the marginal cost of generation in each hour, it will be possible to calculate this, and to rank each half hour in terms of how far above or below the median the price of electricity is.

Starting with the pair of periods with the highest spread between prices, the model will incorporate pumped storage generation when the price is high, and pumping when the price is lowest. This process will continue until either the spread is insufficient to cover the pumped storage operating costs, or no storage capacity is remaining.

Note that the model will apply pumped storage *after* demand profiles have been adjusted for DSR. As explained above, pumped storage and supplier-led DSR can be seen as substitutes for one another. However, while our model incorporates operating costs for pumped storage systems, it will not include such costs for DSR. Applying pumped storage after DSR means that the model prefers to use DSR rather than pumped storage, where possible.

Interconnection

Previous studies have found that DSR and interconnection have complementary roles to play in balancing supply and demand.⁷⁶ Since interconnection does not compete with DSR in the same way as pumped storage, it is more appropriate to take a high-level approach that abstracts away from complex factors such as European-wide correlations in wind generation and demand. We will include interconnector capacities from the scenarios discussed in section 3.2 and will model this using the average price of electricity in each of the connected markets.

In principle, it would be possible for the model to take into account the average price of electricity in each of the connected markets, and simulate exports and imports when it is profitable to do so. However, this would add additional complexity to the modelling so unless the presence of interconnectors is likely to

⁷⁵ This is based on an assumption that supplier-led DSR is enabled by smart meters. As set out in Section 4, we would welcome comments on this assumption

⁷⁶ Pöyry (2011), *DSR follow on*

materially affect the balance of costs and benefits, we do not propose to incorporate them into the model.

6.5 Demand profiles

This section provides more details regarding the interdependencies between the generation and network models. The half-hourly demand profiles provide the main link between the sections of the model.

Both the network and generation models require as an input half-hourly load profiles (whether at the individual feeder level for the network model, or on aggregate across the country for the generation model). However, the availability of technologies such as DSR means that the load profile itself becomes adjustable over time⁷⁷. This section provides an overview of the different demand profiles that we will consider. These are explained in further detail below.

⁷⁷ Embedded storage also has the potential to influence aggregate demand profiles. However, the issues surrounding DSR are more complex (since forms of DSR are available even before any smart grid investment is made). We therefore concentrate in this section upon the treatment of DSR, however embedded storage could be modelled in a similar way.

Table 11. Demand profiles used within the model

	Demand profiles under BAU	Demand profiles with smart investments
Before enhanced smart meter communications available	Initially no DSR Increasing mix of supplier-led static DSR over time	
After enhanced smart meter communications available	Supplier-led dynamic DSR	Feeders without enabling technology remain as under BAU Feeders with enabling technology have DNO-modified demand profile

Source: Frontier Economics

Before enhanced smart meter communications are available, under the BAU

The starting point for our model will be the demand profile without any DSR⁷⁸. However, our business-as-usual assumptions for smart meters imply that they will be capable of “static” time-of-use tariffs, which can incentivise customers to shift demand to where (on average) energy costs are lower.

The demand profile for the various technologies will therefore move towards profile be influenced by static time of use tariffs.

Before enhanced smart meter communications are available, with smart grid investments

We assume that the DNOs are not able to make any use of the DSR capabilities afforded by smart meters without an enhanced communications system. This is because the basic smart meter communications infrastructure may not enable time-of-use tariffs to be set separately for consumers on different feeders, as potentially required by DNOs.

Even if this were not the case, static time-of-use tariffs are likely to be too blunt an instrument for a DNO seeking to minimise peak demand. For example, without a way to send individualised signals to different households, there is a risk that a large number of heat pumps on a feeder may turn on at once.

⁷⁸ This demand profile will incorporate the limited DSR that currently takes place (e.g. economy 7 tariffs) as this will be reflected in the demand profiles inputted into the model.

The technology that enables DNOs to modify the demand profile will therefore not appear in the smart solution stacks until the enhanced smart meter communications infrastructure is in place. Demand profiles will be identical across the BAU and smart solution specifications, and so the generation model will produce identical costs for each (which will net off to zero).

After enhanced smart meter communications are available, under the BAU

After a pre-set date, the model will allow “dynamic” supplier-led time-of-use tariffs, which can be adjusted half-hour by half-hour to lower generation costs.

Note that our model will not explicitly differentiate between different ways in which DSR can be undertaken (e.g. via differing tariffs, or remote dispatch of household appliances). The assumptions made regarding the effectiveness of DSR will relate to the amount of energy that can be shifted for (for example) a heat pump, rather than the methods by which this is undertaken.

After enhanced smart meter communications are available, with smart grid investments

In this case, the local DNO will have the option to modify demand in order to reduce peak loads (and therefore increase network headroom) on individual feeders. The implementation of such a DSR profile would require enabling “smart” investments for each relevant feeder⁷⁹. This will therefore be one of the smart solutions available on the priority stack in the network model.

It is important to note that the demand profile with such “DNO modified” DSR will in many cases be identical to that under the supplier-led dynamic DSR. As long as network headroom is sufficient, the DNO will not need to adjust the profile of demand, and so the benefits in terms of generation cost savings will continue to accrue.

6.5.1 DSR for system security services

A final application for DSR involves the use of rapid demand-side response to compensate for unexpected losses of supply (for example if a power plant suddenly fails). In principle, the use of DSR for such system services could lessen the need for expensive spinning reserve.

However, we are proposing to assume that the latency of DSR facilitated by smart meters and smart grids will be half an hour or less (as set out in Section 4.1.2). Unless the latency is significantly lower than this, we consider that it would not be possible to rely upon DSR for providing the immediate response required

⁷⁹ For example, this could involve substation sensing to identify the exact level of peak demand, which will depend on factors such as the clustering of LCTs.

to arrest a drop in frequency. We therefore do not propose to model this type of DSR.

6.5.2 Modelling DSR

Figure 24 illustrates the process required to produce the various demand profiles required by the model. This involves the passing of demand profiles between the network and generation models.

Figure 24. Overview of model interlinkages for DSR

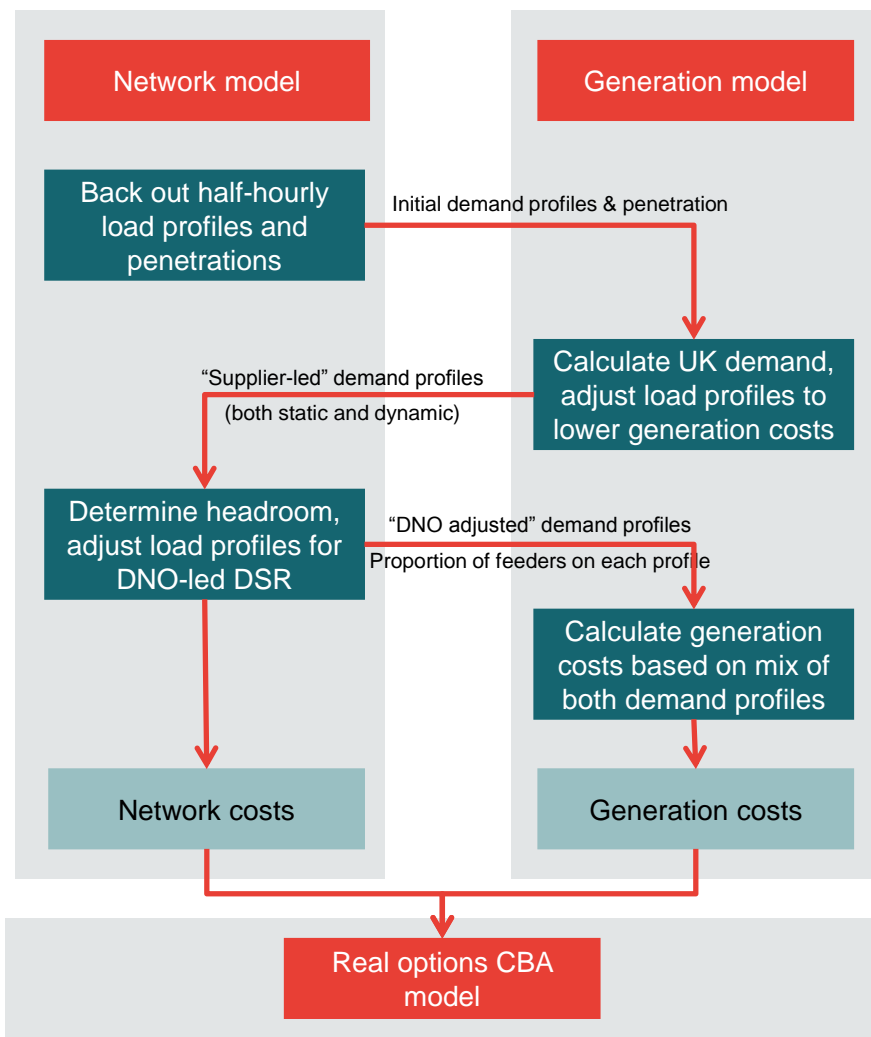

Source: Frontier Economics

Modelling supplier-led DSR

The starting point for modelling supplier-led DSR is the existing half-hourly demand profiles for low-carbon technologies. These will be collated by the network model, along with overall penetration rates.

The generation model will use these figures (together with demand from any other sources) to determine demand net of intermittent sources. To calculate the supplier-led static demand profile, only average intermittent generation need be considered. In order to model dynamic supplier-led DSR, though, the model will independently consider demand net of wind under each of the representative wind profiles.

The model will then consider how the profile of technologies amenable to DSR (such as heat pumps) can be adjusted in such a way as to lower supply costs. We envisage that this adjustment will take place through the use of simple heuristics (primarily ensuring that the low-carbon technology demand varies in a way which matches wind supply). These will respect basic constraints regarding the extent to which energy can be transferred across time (for example, it is unrealistic to expect a substantial amount of EVs to charge during the morning rush hour). In such a way, patterns of usage for each low-carbon technology in each season will be produced. These are used as the baseline demand profile for the network model (before the smart investment which enables DNO-adjusted DSR is made).

A model that fully optimises the deployment of demand response is outside the scope of this project. As a result, the demand profiles that the model creates will still have scope for further optimisation. To the extent to which this occurs in both the business-as-usual and “smart” worlds, the overall effect of any failure to optimise DSR will tend to net off in the overall calculations. However, we plan to build the model in such a way that the output from a more elaborate optimising model could be incorporated in the future, if desired.

Modelling DNO-adjusted DSR

For each representative feeder (and each level of clustering), the network model will keep track of a set of adjusted demand profiles which are just sufficient to bring peak load down to a point which defers the next required investment in the solution stack. The basis for these demand profiles will be the dynamic supplier-led profiles (as described previously, it is considered that DNO-adjusted DSR will not be possible with static time-of-use tariffs).

Again, these updated load profiles are required to be consistent with basic constraints regarding the transfer of energy over time, and will be constructed using a similar methodology to the supplier-led DSR. The model will keep track of how much demand-shifting capacity remains after the supplier-led DSR (in very broad terms – a model which keeps track of exactly what amount of demand can be moved from each period to each other period may be unmanageable).

In theory, the modelled adjustments made by DNOs to demand could have an overall detrimental effect upon the net present value of smart grids (if the benefit of postponed reinforcement is outweighed by increased generation costs). Our model will not seek to select a fully “optimal” pattern of investment in DNO-led

Proposed model specification

DSR that minimises overall costs.⁸⁰ However, by adjusting the position of DSR within the network solution stacks, it will be possible to determine how sensitive the overall costs are to this issue. Further, the DNO-adjusted profile is unlikely to vary greatly from the supplier-led one (since both will tend to reduce peak demand where possible).

Final generation calculations

To calculate the overall costs of generation, the generation model will build a final aggregate demand profile. This will use data from the network model on the proportion of feeders running the original supplier-led DSR profile, and the proportion (if any) that have been converted to a DNO-adjusted DSR profile.

6.5.3 Limitations regarding the treatment of DSR

To produce a tractable model, some of the more complex “feedback” effects that could be created by DSR will be excluded. These are explained below.

If the DNO-adjusted demand profile were significantly different to the supplier-led profile, the following sequence of events could take place:

1. Over time, feeders would move from supplier-led to DNO-adjusted DSR profiles.
2. This would lead to the overall GB-wide demand profile changing.
3. This could itself result in the optimal supplier-led profile changing, to ensure that demand net of intermittent sources is as flat as possible.
4. The new supplier-led profile could itself lead to different levels of headroom on individual feeders – which would itself lead to a different number of feeders on each demand profile.

⁸⁰ However, if a DNO has already invested in DSR and not conventional reinforcement, it would almost certainly be optimal for the DNO to use DSR (if available) to avoid breaching headroom limits. This is since the cost of running a feeder above its design capacity will probably exceed the costs associated with a short period of slightly higher-cost generation. Therefore, while the investments made by the DNO in the model may not be completely optimal, the modelled demand profiles (given these investments) may be.

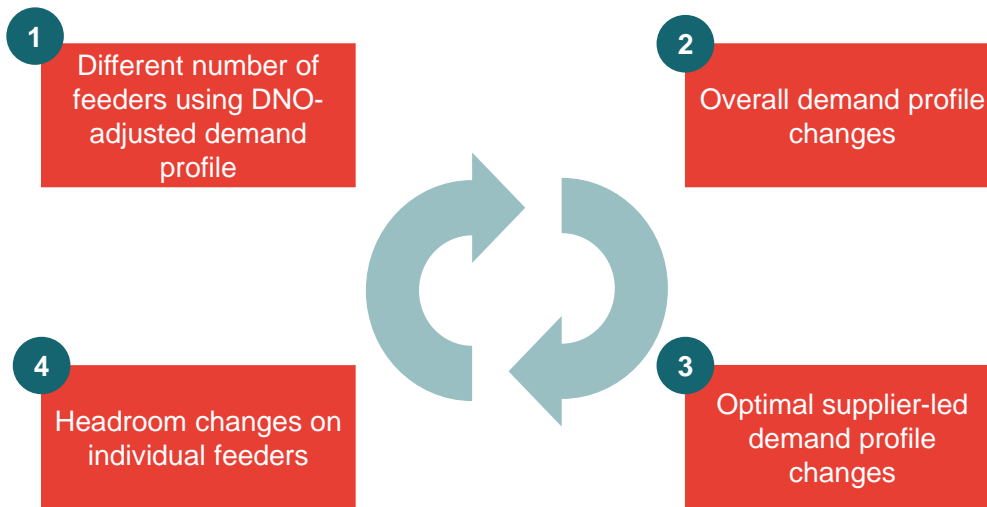
Figure 25. Feedback effects

Source: Frontier Economics

A model which allowed this type of feedback effect would need to simultaneously optimise both the supplier-led and DNO-modified DSR profiles. This would greatly increase the complexity of the model.

Instead, the model we propose explicitly rules out such feedback effects: the supplier-led DSR profile will not be able to respond to changes in the DNO-modified profile. Since the DNO will only need to adjust demand when headroom is breached, the overall change upon the demand profile is likely to be small. We therefore think little will be lost from this simplification and there will be benefits in terms of keeping the model transparent and usable.

Questions for consultation from section 6

We would particularly welcome responses to the following questions.

- How suitable is the proposed network modelling methodology which uses representative networks, with headroom used to model when network investments should be made on feeders?
- Are the voltage levels (from 132kV down to LV) being considered by the network model appropriate, or should the model be limited to focus on any particular voltage levels?
- For each of the voltage levels we are considering, are current methods sufficient to recognise available headroom and the cost of releasing additional headroom in these networks? If not, is the proposed approach considered to be too simple or overly complex?
- Is our approach to estimating the clustering of low-carbon technologies appropriate? Is any other evidence available in this area?
- Are the proposed generation model assumptions (a simple stack of generator types, no technical dispatch constraints, half-hourly demand profiles for summer and winter, and representative wind profiles) suitable?
- Should a simple representation of interconnection be included in the model?
- Does the model represent DSR (“supplier-led” and “DNO-modified” profiles, with simple heuristics used rather than simultaneous optimisation) adequately?

7 Annexe A – literature review

We have reviewed a range of documents in order to develop our understanding of the issues involved in attempting to define the costs and benefits of smart grid investment. Two previous reports (by ENSG and EPRI) are particularly applicable to this work, and we summarise the CBA methodology they use in Table 12 below.

In the sections that follow, we summarise the conclusions of prior work regarding:

- the technologies that may be involved in the smart grid;
- the costs and benefits of these developments;
- the factors which are likely to affect the extent to which these benefits are realised; and
- how demand-side response (DSR) can be deployed and modelled.

Table 12. Comparison of the ENSG and EPRI CBAs

	ENSG (2010)	EPRI (2011)	
Scope and methodology	Geographic scope	GB	US
	Period covered	Investments in the period 2010 – 2030 NPV calculated out to 2050	2010 - 2030
	Period subdivided?	Phase 1 (2010 – 2020) Phase 2 (2020 – 2030)	No
	Treatment of uncertainty	High/low estimates for phase 1 Recognition of high levels of uncertainty for phase 2	High/low estimates provided for costs and benefits
	Treatment of optionality / “lock-in”	It is recognised that “the phase 1 investments... provide the foundations for future optionality”	No
Outcomes⁸¹	Connection and use of low-carbon technologies	Carbon benefits not included (included within assumed electricity price).	Includes reduced environmental impact from facilitating low-carbon generation and transport
	Maintenance of network standards	Includes benefit of reduced outages	Includes benefits from increased reliability and security of supply

⁸¹ In particular, we consider those outcomes that are held constant. As an example, the smart grid may make it more cost-effective to introduce various low-carbon technologies. One way of dealing with this is to value the resulting carbon benefits (versus business-as-usual) directly. Alternatively, carbon emissions can be fixed and the alternative means of accommodating the low-carbon technologies can be costed.

Included smart technologies	Demand-side response	Included	Included
	Smart meters	<i>Not included</i> ⁸²	Included
	Distributed generation	<i>Not included</i> ⁸³	Integration costs included
	Distributed storage	<i>Not included</i> ⁸⁴	Includes integration of V2G
	Distribution network sensing/control (e.g. automated voltage control)	Included	Included
	Dynamic thermal ratings on distribution network	<i>Not included</i> ⁸⁵	<i>Not included</i> ⁸⁶
	Transmission network technologies (e.g. FACTS)	<i>Not included</i> ⁸⁷	Included
	Bulk (transmission-level) storage	<i>Not included</i>	Included

⁸² Costs and benefits are incremental to those for smart meters in isolation.

⁸³ Considered as a value driver

⁸⁴ V2G considered as a value driver

⁸⁵ Dynamic line rating is discussed as a possible smart technology, but does not appear to have been incorporated into the CBA.

⁸⁶ Dynamic thermal rating is only included on the transmission network.

⁸⁷ While these technologies are briefly discussed, the CBA itself concentrates on the distribution network.

Results	Final results	Phase 1 NPV of between +£1bn and -£0.17bn out to 2050 (benefit-to-cost ratio of 0.97 - 1.18) ⁸⁸	NPV of +\$1.294bn - +\$2,028 out to 2030
		Phase 2 NPV of +£2.7bn (highly uncertain) out to 2050 (benefit-to-cost ratio of approximately 2.59)	Corresponds to a benefit-to-cost ratio of 2.8 – 6.0

Source: Frontier Economics

7.1 Technologies involved in the smart grid

The various studies identify a wide range of technologies that can be seen as part of the smart grid. Below, we briefly outline the different types of solution that have been considered.

7.1.1 Demand-side response

Demand-side response is included as a “smart” technology in virtually all of the literature we have reviewed, although the scope of which costs appear in the CBA varies. In particular, the ENSG CBA includes the costs of smart appliances. By contrast, the ERPI study argues that the increased presence in microprocessors in such appliances already means that they could be made “smart” at little incremental cost.

7.1.2 Smart meters

There are many interdependencies between the installation of smart meters, and the smart grid. Cost-benefit analyses may differ in which of the costs and benefits of smart meters are included (as, if the rollout of smart meters is taken as given, any costs or benefits they accrue in themselves will not differ between the “business-as-usual” and smart grid worlds).

In order for the DNO to make use of data from smart meters, a communications infrastructure is required. The ENSG CBA notes that there may be scope to link the communications required for smart meters and the rest of the smart grid, reducing the overall cost. However, it adds that some smart grid functionality may have very different communications requirements. The approach taken is to estimate the *additional* cost (on top of those stated in the May 2009 Smart Meter CBA) required to install a communications system for both smart meters and the smart grid.

⁸⁸ Constructed using NPV and discounted benefit figures.

By contrast, the EPRI CBA includes the costs and benefits that are directly attributable to smart meters, without separating these from the wider benefits of the smart grid.

7.1.3 Distributed generation and storage

The studies that consider distributed generation typically do not consider the costs of distributed generation technologies (such as solar cells) themselves as part of the smart grid, but rather as a value driver (see below). However, the ERPI study does include the costs of integrating micro-generation into the grid, including the inverters used within micro photovoltaic installations.

EVs with vehicle-to-grid (V2G) capabilities provide a form of distributed storage, which is generally assumed to be controlled through DSR. In a similar way to its treatment of micro PV, the ERPI study only includes integration costs, rather than the EVs themselves. The ESNG CBA assumes that a high penetration of V2G will only be feasible from 2040 onwards.

7.1.4 Distribution network developments

The ENSG CBA incorporates benefits from voltage optimisation, in addition to enhanced substation sensing, control and communications equipment. Similarly, the EPRI study considers a variety of interventions on the distribution network, such as greater automation of feeders and intelligent universal transformers.

Dynamic thermal ratings are described as a smart grid technology in the ENSG study (the Skegness 132kV scheme is mentioned), although they do not appear to be incorporated in the actual CBA.

7.1.5 Transmission network developments

The EPRI CBA includes costs and benefits relating to the transmission network, including:

- dynamic-thermal circuit rating;
- substation and transmission line sensors;
- transmission short-circuit current limiters;
- FACTS (Flexible AC Transmission System) devices;
- communications infrastructure;
- phasor measurement units;
- intelligent electronics devices; and
- additional cyber security measures.

The ENSG CBA generally concentrates on possible developments within the distribution network, rather than the transmission network. FACTS is mentioned as a technology which could form part of a smart grid, however the costs and benefits relating to this do not appear to be contained within the CBA itself.

7.1.6 Bulk (transmission-level) storage

Like demand response, the use of bulk storage (for example, pumped storage facilities) facilitates the balancing of electricity supply and demand. The ERPI CBA includes the cost of adding compressed air energy storage (CAES) to the transmission network.

The ENSG CBA does not include any costs or benefits arising from the installation of additional bulk storage capacity.

7.2 Costs and benefits arising from a smart grid

The smart grid technologies above may lead to a number of different types of benefits – below, we summarise some of the themes found within the literature.

7.2.1 Reduced distribution network capex

The literature generally indicates that smart grids will be capable of delivering (at least) the same outcomes on the distribution network, with lower levels of capital expenditure. One reason for this is that technologies such as DSR, dynamic thermal ratings and simply better monitoring may reduce (or delay) the need to reinforce the distribution network. The ENSG CBA considers the latter two features, while both the 2010 Pöyry study and Strbac et al (2010) examine in more detail the effect that DSR could have on required reinforcement.

In addition, the ENSG CBA indicates that the improved monitoring and control capabilities on the distribution network may lead to a reduced asset failure rate.

7.2.2 Avoided generation costs

Dispatch of demand response and distributed generation may enable demand to be shifted to periods with the lowest marginal costs of generation (these costs may include any carbon emissions). This is included as a benefit in both the ENSG and ERPI studies, while the DSR reports discussed below (for example, Ofgem's 2010 discussion paper) also examine this issue.

7.2.3 Facilitating the connection of low-carbon technologies

If the smart grid enables technologies such as electric vehicles, heatpumps and renewable generation to be integrated into the network in a more cost-effective

Annexe A – literature review

fashion, it may be appropriate to include the environmental impact of this in the CBA. This is the approach taken by the ERPI CBA.

By contrast, the ENSG CBA treats the penetration of such technologies as fixed value drivers (see the following section).

7.2.4 Maintenance of network standards

Both the ENSG and ERPI CBAs include as a benefit the reduced outages that are assumed to arise from a system with better distribution network monitoring. The latter includes a wider variety of benefits, such as an improved ability for the network to deal with attack and natural disaster.

7.3 Smart grid value drivers

The literature that we have reviewed consider a variety of different factors which could affect the benefits that accrue from smart grid investment. Below, we summarise some of these key value drivers (excluding those which simply relate to the performance of a given smart technology, such as how effective voltage optimisation may be in practice).

7.3.1 Availability of DSR (including penetration of EVs and HPs)

The amount of peak power consumption that can be shifted with DSR forms a key assumption for many of the reports (see below for further information). As indicated in the ENSG CBA, this will be driven by both levels of customer engagement, as well as technological developments (such as the availability of vehicle-to-grid charging for electric vehicles). Factors such as typical driving and charging patterns for EVs (considered by Strbac et al (2010)) will also affect the overall benefits gained from DSR.

7.3.2 Pumped storage and interconnection

Increasing levels of transmission-level storage or interconnection provide another way of reshaping demand, which may decrease the incremental benefits to be gained from demand-side management⁸⁹.

The 2011 follow-on to Pöyry's study into DSR for DECC examines these issues. It is noted that DSR and pumped storage may to some extent be substitutes: pumped storage rates of return are likely to be lower in a world with DSR (due to the flattening of prices and redistribution of demand that occurs with DSR). By

⁸⁹ Specifically, the benefits obtained from better utilisation of cheaper forms of generation (such as wind). Storage and interconnection on the transmission network is unlikely to affect the benefits of DSR on the distribution networks, where it may postpone the need for reinforcement.

contrast, it is noted that interconnection (especially to Norway) may play a complementary role to DSR. In the modelled scenarios, DSR tends to increase exports over this interconnector.

As described above, the ERPI report includes some forms of transmission-level storage as a smart solution itself, rather than as a value driver.

7.3.3 Availability of distributed generation

The penetration of distributed generation (DG) can affect the value from smart grid solutions in two significant ways. Firstly, the smart grid may enable the dispatch of DG in order to overcome issues such as renewable intermittency. The increased usage of DG will lead to higher benefits in these areas, as recognised in the ENSG CBA and the Pacific Northwest report.

In addition, forms of DG such as photovoltaic cells can lead to voltage control issues on the distribution network, which can be mitigated with smart solutions. The extent of the benefits that can be delivered by the smart solutions will depend on the penetration of such generation on individual feeders (clustering is a particular important phenomenon here). The 2010 Pacific Northwest report explores this issue further.

7.3.4 Generation mix

To the extent that the smart grid can facilitate the connection (and utilisation) of intermittent renewable energy, the amount of energy supplied by such sources will drive some of the benefits. This point is made by the 2010 Pacific Northwest report, which notes how distributed generation, distributed storage and demand response can reduce the capacity of traditional generation required for services such as spinning reserve.

Studies such as Pöyry's 2010 DSR work incorporate the generation mix (including wind intermittency) as an input to determine the benefits that can accrue, although in many instances the generation mix is not itself varied across multiple scenarios. For example, this report utilises the generation mix from DECC's Pathway Alpha, while Ofgem's 2010 discussion paper on DSR uses the 2020 "Green Transition" scenario for generation costs.

7.4 Modelling of demand-side response

As seen above, demand-side response (DSR) is one of the key elements of the smart grid. It is also one of the most challenging elements to model fully: a full optimisation of DSR would require taking into account the different technical constraints upon the vast number of appliances which can be remotely dispatched.

Where previous studies have modelled DSR, they have handled these assumptions in different ways. Some of them make relatively high-level assumptions (for example regarding the proportion of demand which can be shifted from peak to the night). This permits a very transparent approach, but means that the model cannot easily assess the impact of varying assumptions (for example, changing penetrations of electric vehicles and heatpumps). By contrast, some studies take a “bottom up” approach that considers the technical constraints of each type of appliance, within an optimising dispatch model.

- **Ofgem’s 2010 discussion paper on demand-side response** makes the high-level assumption that between 5% and 15% of peak domestic demand can be shifted from the peak to later in the evening (similar assumptions are made for other sectors). This is based upon the Global Insight 2009 study “Demand Side Market Participation Report”.
- The **ENSG (2009) CBA** also appears to rely upon basic assumptions regarding peak demand levels; it is assumed that take-up of demand-side-response varies from 12% in the base case, to 2% in the low case. However, it is not entirely clear from the material we have how the benefits themselves were derived.
- Where LCNF submissions place a value upon the benefits from DSR, this generally involves a “top-down” approach, which makes assumptions regarding the percentage of demand that can be shifted. For example, the **Demand Side Management of Electric Storage Heating** submission makes the assumption that 5% of UK demand is capable of being shifted from the peak (consistent with the Ofgem report). Benefits are calculated on the basis that this demand, previously associated with high marginal costs, will take place during periods of average generation cost.
- The original **Thames Valley Vision** proposal assumes that DSR will enable peak demand from 15:00 to 20:00 to be re-allocated to the off-peak period 00:00 to 05:00. In order to calculate the potential carbon savings from DSR, representative half-hourly demand profiles are provided for March, June, September and December 2010. Emissions intensities can be calculated for these profiles, and for a DSR profile where demand has been shifted away from the peak.
- The **2010 Pöyry report** applies a bottom-up modelling of DSR. Demand is split between “inflexible” demand, and “flexible” demand, which consists of three categories of appliance: residential washing units, heating and electric vehicles. These are characterised by their:
 - daily demand profile;

- charging rate;
- availability for charging/use;
- minimum “on” time;
- storage capacity;
- minimum storage levels;
- rate of energy loss in storage;
- fuel switching capability; and
- capability to return energy to the grid.

An assumption is also made regarding the proportion of these units which can be subject to DSR.

These DSR-capable units can then be dispatched by an optimising model (it is assumed that consumers have no control over the dispatch) to either minimise generation costs, or reduce peak demand. The model has an hourly resolution, and covers a year.

- **Strbac et al (2010)** similarly considers three categories of flexible demand: electric vehicles, heat pumps, and smart domestic appliances (washing machines, tumble driers, and combined washer-driers). The model optimises the usage of these appliances in order to flatten demand (based around hourly demand in a representative winter day, with various constraints upon DSR).

This paper does highlight the interactions between the optimised demand responses of different sectors. For example, with heat pumps only, it is optimal to shift a much heat-related load to the night (despite the associate energy losses). By contrast, if electric vehicles are also available (and charging at night), heat pumps can be used with less storage requirements.

7.5 Bibliography

7.5.1 Cost-benefit analyses and related work

ENSG (2010), *A Smart Grid Vision*

ENSG (2010), *A Smart Grid Routemap*

EPRI (2011), *Estimating the Costs and Benefits of the Smart Grid*

Pacific Northwest National Laboratory for the US Department of Energy (2010), *The Smart Grid: An Estimation of the Energy and CO₂ Benefits, Rev 1*

Annexe A – literature review

7.5.2 Demand-side response

Ofgem (2010), *Demand Side Response – A Discussion Paper*

Pöyry, for DECC (2010), *Demand Side Response: Conflict Between Supply and Network Driven Optimisation*

Pöyry, for DECC (2011), *DSR follow on – final presentation*

Strbac, G et al (2010), *Benefits of Advanced Smart Metering for Demand Response based Control of Distribution networks*

Strbac, G (2008), *Demand-side management: benefits and challenges*

7.5.3 DECC Smart Meter Impact Assessment

DECC (2011), *Smart meter rollout for the domestic sector (GB)*

DECC (2011), *Smart meter rollout for the small and medium non-domestic sector*

7.5.4 LCNF Second Tier proposals

We have reviewed the proposals and supporting documents for all LCNF Second Tier projects.

7.5.5 Other documents

Element Energy, for UKPN (2011), *Modelling future load growth on UKPN networks*

CEER (2011), *CEER Status Review of Regulatory Approaches to Smart Electricity Grids*

FRONTIER ECONOMICS EUROPE

BRUSSELS | COLOGNE | LONDON | MADRID

Frontier Economics Ltd 71 High Holborn London WC1V 6DA

Tel. +44 (0)20 7031 7000 Fax. +44 (0)20 7031 7001 www.frontier-economics.com